

GX SERIES

GX-200/GX-300/GX-400

GX-600/GX-800/GX-1000

GX-2000/ GX-3000/GX-4000/GX-6100

GX-6000/GX-8000

Multi-Function Balance

INSTRUCTION MANUAL



© 2005 A&D Company Ltd. All rights reserved.

No part of this publication may be reproduced, transmitted, transcribed, or translated into any language in any form by any means without the written permission of A&D Company Ltd.

The contents of this manual and the specifications of the instrument covered by this manual are subject to change for improvement without notice.

CONTENTS

Basic Operation

1. INTRODUCTION	3
1-1 About This Manual	3
1-2 Features	3
1-3 Compliance	4
2. UNPACKING THE BALANCE	6
2-1 Unpacking	6
2-2 Installing the Balance	7
3. PRECAUTIONS	8
3-1 Before Use	8
3-2 During Use	8
3-3 After Use	9
3-4 Power Supply	9
3-5 Display Symbols and Key Operation	10
4. WEIGHING UNITS	11
4-1 Units	11
4-2 Storing Units	13
5. WEIGHING	14
5-1 Basic Operation (Gram Mode)	14
5-2 Counting Mode (PC)	15
5-3 Percent Mode (Pct)	17
5-4 Animal Weighing Mode (Hold Function)	17

Adapting to the Environment

6. RESPONSE ADJUSTMENT / SELF CHECK FUNCTION	18
6-1 Automatic Response Adjustment / Self Check Function	18
6-2 Manual Response Adjustment	19
7. CALIBRATION	20
7-1 Calibration Group	20
7-2 Automatic Self Calibration (Calibration due to changes in temperature)	22
7-3 Calibration Using the Internal mass (One-Touch Calibration)	23
7-4 Calibration Using an External Weight	24
7-5 Calibration Test Using an External Weight	26
7-6 Correcting the Internal Mass Value	28

Functions

8. FUNCTION SWITCH AND INITIALIZATION	30
8-1 Permit or Inhibit	30
8-2 Initializing the Balance	31
9. FUNCTION TABLE	32
9-1 Structure and Sequence of the Function Table	32
9-2 Display and Keys	32

9-3 Details of the Function Table	33
9-4 Description of the Class “Environment, Display”	36
9-5 Description of the Item “Data output mode”	38
9-6 Description of the Item “Data format”	39
9-7 Description of the Data Format Added to the Weighing Data	39
9-8 Data Format Examples	42
9-9 Clock and Calendar Function	44
9-10 Comparator Function	46
10. ID NUMBER AND GLP REPORT	48
10-1 Setting the ID Number	48
10-2 GLP Report.....	49
11. DATA MEMORY	52
11-1 Notes on Using Data Memory.....	52
11-2 Memory for Weighing Data	53
11-3 Memory for Calibration and Calibration Test Data	56
11-4 Memory for Unit Mass in the Counting Mode	57
12. UNDERHOOK.....	58
13. PROGRAMMABLE-UNIT	59
14. DENSITY MEASUREMENT	60

RS-232C Serial Interface

15. RS-232C SERIAL INTERFACE / EXTERNAL INPUT	63
16. CONNECTION TO PERIPHERAL EQUIPMENT	65
16-1 Connection to the AD-8121B Printer	65
16-2 Connection to a Computer.....	65
16-3 Using Windows Communication Tools (WinCT).....	65
17. COMMANDS	67
17-1 Command List.....	67
17-2 Acknowledge Code and Error Codes	68
17-3 Control Using CTS and RTS	69
17-4 Settings Related to RS-232C	69

Maintenance

18. MAINTENANCE	70
19. TROUBLESHOOTING	70
19-1 Checking the Balance Performance and Environment.....	70
19-2 Error Codes	71
19-3 Asking For Repair	74
20. SPECIFICATIONS.....	75
21. OPTIONS	77
22. EXTERNAL DIMENSIONS	78
23. TERMS/INDEX.....	79

1. INTRODUCTION

This manual describes how the GX series balance works and how to get the most out of it in terms of performance.

Read this manual thoroughly before using the balance and keep it at hand for future reference.

1-1 About This Manual

This manual consists of the following five parts:

- Basic operation.....Describes precautions on handling the balance, balance construction and basic balance operation.
- Adapting to the environment.....Describes response adjustment, calibration and calibration test.
- FunctionsDescribes various functions of the balance.
- RS-232C serial interface.....Describes the interface which transmits data and controls the balance.
- MaintenanceDescribes maintenance, error codes, troubleshooting, specifications and options.

1-2 Features

- Built-in Calibration Weight (hereinafter referred to as internal mass), allows easy calibration, adjustment and maintenance of the balance.
- Automatic Self Calibration, using the internal mass, adapting to changes in temperature.
- Self Check Function, provided to self-check the balance using the internal mass.
- Automatic Response Adjustment, adapting to vibration and drafts in the environment.
- Stabilization time of one second. When **FAST** is selected for the response rate, a stabilization time of one second, to read a displayed value after a sample is placed on the pan, has been achieved.
- Data Memory Function, storing weighing data, calibration data or unit mass in the counting mode. (About weighing data, 200 sets of data can be stored.) Interval Memory Mode is provided to weigh a sample and store the weighing data periodically.
- Good Laboratory Practice (GLP) data output using the standard RS-232C serial interface.
- Windows Communication Tools (WinCT), allows easy communication with a Windows-based personal computer.
Windows is the registered trademark of the Microsoft Corporation.
- Clock and Calendar Function, adding the time and date to the output data.
- Comparator Indicators, displaying the comparison results.
- Capacity Indicator, displaying the weight value in percentage relative to the weighing capacity.

- Hold Function, provided for weighing a moving object such as an animal.
- Underhook, for measuring density and weighing magnetic materials.
- Density Mode, for calculating the density of a solid.
- Multiple Weighing Units, with most of the common units used around the world.
- Reference Card, provided for a quick reference to the balance operation.
- Breeze Break, provided for GX-200/300/400/600/800/1000, for more accurate weighing.

1-3 Compliance

Compliance with FCC Rules

Please note that this device generates, uses and can radiate radio frequency energy. This device has been tested and has been found to comply with the limits of a Class A computing device pursuant to Subpart J of Part 15 of FCC rules. These rules are designed to provide reasonable protection against interference when this device is operated in a commercial environment. If this unit is operated in a residential area, it may cause some interference and under these circumstances the user would be required to take, at his own expense, whatever measures are necessary to eliminate the interference.

(FCC = Federal Communications Commission in the U.S.A.)

Compliance with EMC Directives



This device features radio interference suppression in compliance with valid EC Regulation 89/336/EEC.



A & D Instruments Ltd. hereby declare that the following weighing product conforms to the requirements of the council directives on ...

Electromagnetic Compatibility (EMC) 89/336/EEC

Low voltage equipment (LVD) 73/23/EEC amended by 93/68/EEC

provided that they bear the CE mark of conformity as shown above.

GF and GX Series Balance

Standards applicable :

BS EN 55022 Limits of disturbance for information technology equipment

BS EN 50082 Parts 1 and 2 Generic immunity standards

BS EN 60950 Safety of information technology equipment

CE Mark First Applied April 2000

Signed for A&D Instruments in Oxford England June 2005

Takeo Goto
Managing Director

... Clearly a Better Value



2. UNPACKING THE BALANCE

2-1 Unpacking

- The balance is a precision instrument. Unpack the balance carefully. Keep the packing material to be used for transporting the balance in the future.
- The packing contents depend on the balance model. See the illustrations to confirm that everything is contained.

GX-200/300/400/600/800/1000

How to assemble the breeze break (Only for GX-200/300/400/600/800/1000)

Assemble the breeze break as shown below.
Follow the numbered sequence.

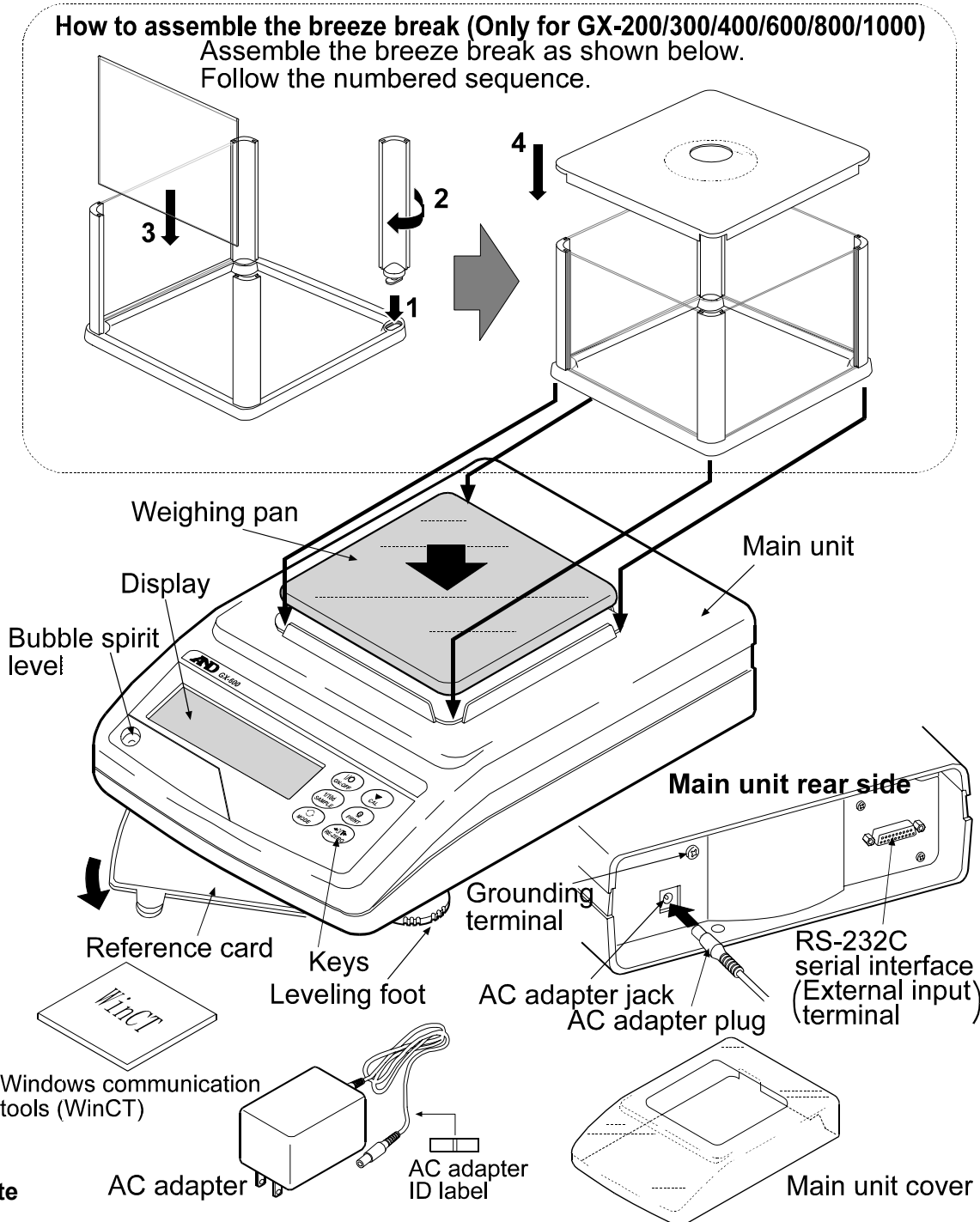

Note

AC adapter

AC adapter ID label

Please confirm that the AC adapter type is correct for your local voltage and receptacle type.

GX-2000/3000/4000/6100/6000/8000

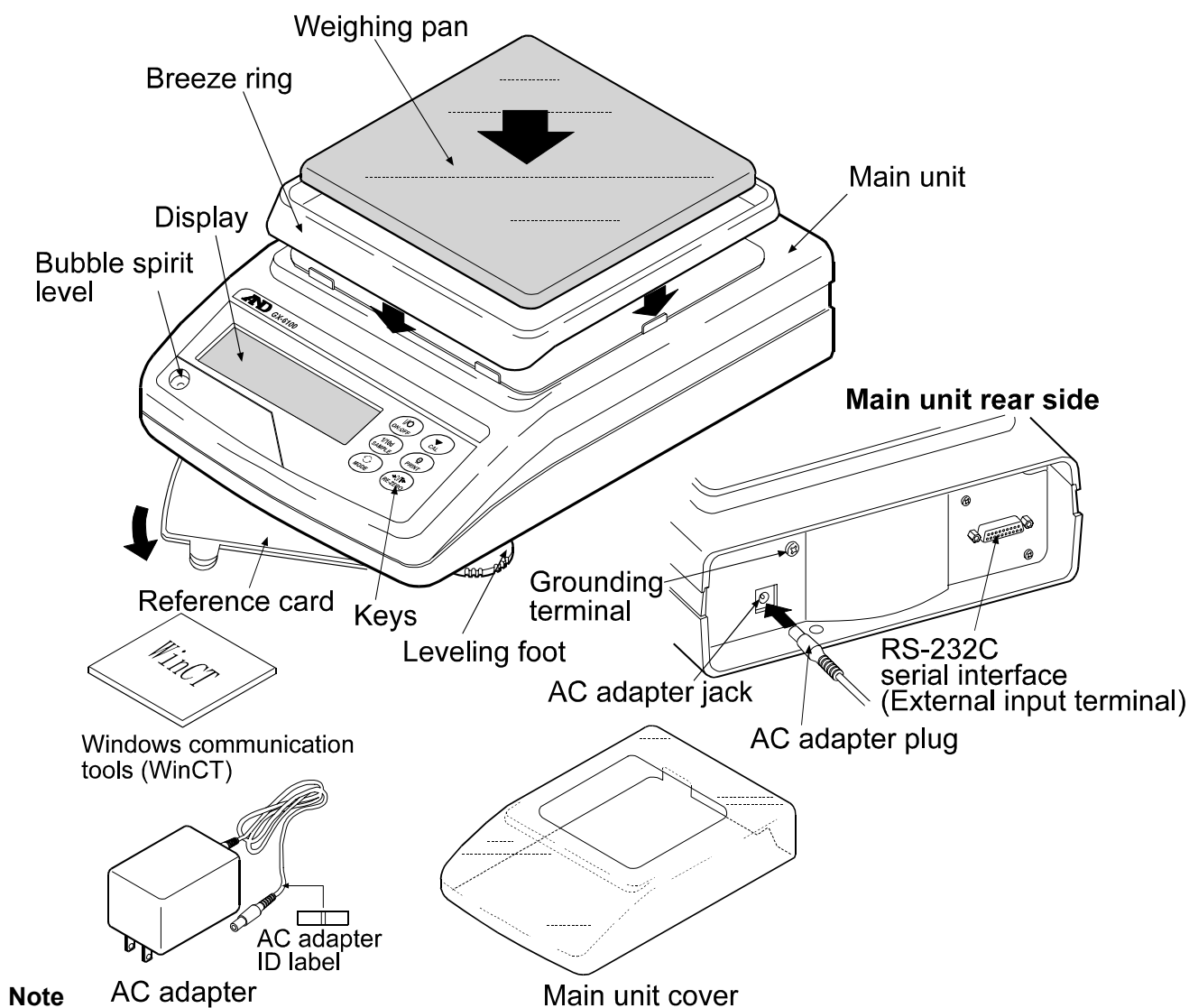

Note AC adapter

Please confirm that the AC adapter type is correct for your local voltage and receptacle type.

2-2 Installing the Balance

Install the balance as follows:

1. Refer to "3. PRECAUTIONS" for installing the balance. Place the balance on a solid weighing table.
2. GX-200/300/400/600/800/1000
Assemble the breeze break on the balance as shown in the illustration above.
GX-2000/3000/4000/6100/6000/8000
Assemble the breeze ring and weighing pan on the balance as shown in the illustration above.
3. Adjust the leveling feet to level the balance. Confirm it using the bubble spirit level.
4. Confirm that the adapter type is correct for the local voltage and power receptacle type.
5. Connect the AC adapter to the balance. Warm up the balance for at least 30 minutes with nothing on the weighing pan.

3. PRECAUTIONS

To get the optimum performance from the balance and acquire accurate weighing data, note the following:

3-1 Before Use

- Install the balance in an environment where the temperature and humidity are not excessive. The best operating temperature is about 20°C / 68°F at about 50% relative humidity.
- Install the balance where it is not exposed to direct sunlight and it is not affected by heaters or air conditioners.
- Install the balance where it is free of dust.
- Install the balance away from equipment which produces magnetic fields.
- Install the balance in a stable place avoiding vibration and shock. Corners of rooms on the first floor are best, as they are less prone to vibration.
- The weighing table should be solid and free from vibration, drafts and as level as possible.
- Level the balance by adjusting the leveling feet and confirm it using the bubble spirit level.
- Ensure a stable power source when using the AC adapter.
- Warm up the balance for at least 30 minutes. Plug in the AC adapter as usual.
- Calibrate the balance before use or after having moved it to another location.

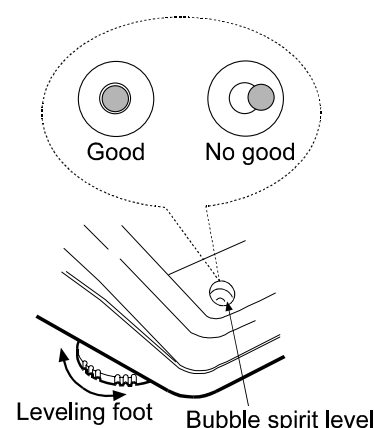

Caution

Do not install the balance where flammable or corrosive gas is present.

3-2 During Use

- Discharge static electricity from the material to be weighed (hereinafter referred to as sample). When a sample could have a static charge, the weighing data is influenced. Ground the balance and try the following:
 - Eliminate the static electricity by AD-1683 as an accessory.
 - Or try to keep the ambient humidity above 45%RH.
 - Or use the metal shield case.
 - Or wipe a charged plastic sample with the wet cloth.
- This balance uses a strong magnet as part of the balance assembly, so please use caution when weighing magnetic materials such as iron. If there is a problem, use the underhook on the bottom of the

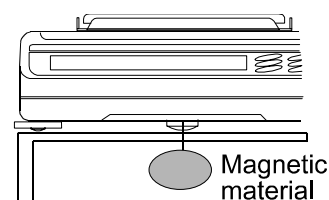
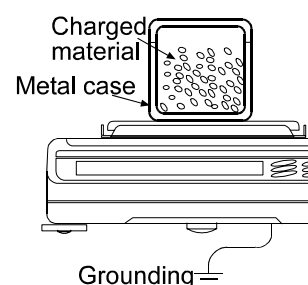

balance to suspend the material away from the influence of the magnet.

- Cancel the temperature difference between a sample and the environment. When a sample is warmer (cooler) than the ambient temperature, the sample will be lighter (heavier) than the true weight. This error is due to a rising (falling) draft around the sample.
- Make each weighing gently and quickly to avoid errors due to changes in the environmental conditions.
- Do not drop things upon the weighing pan, or place a sample on the pan that is beyond the balance weighing capacity. Place a sample in the center of the weighing pan.
- Do not use a sharp instrument such as a pencil to press the keys. Use your finger only.
- Press the **RE-ZERO** key before each weighing to prevent possible errors.
- Calibrate the balance periodically so as to cancel possible errors.
- Take into consideration the affect of air buoyancy on a sample when more accuracy is required.
- Keep the balance interior free of dust and foreign materials.
- The breeze break (GX-200/300/400/600/800/1000 only) and the clear main unit cover are provided as accessories. The breeze break components may be charged with static electricity when they are unpacked or when the humidity is low. If the weighing value is unstable or the balance has a problem with repeatability, remove the breeze break. Or wipe the clear plates with a moistened cloth, use an accessory DC static eliminator, AD-1683, or apply an anti-static spray.

3-3 After Use

- Avoid mechanical shock to the balance.
- Do not disassemble the balance. Contact the local A&D dealer if the balance needs service or repair.
- Do not use organic solvents to clean the balance. Clean the balance with a lint free cloth that is moistened with warm water and a mild detergent.
- Avoid dust and water so that the balance weighs correctly. Protect the internal parts from liquid spills and excessive dust.

3-4 Power Supply

- Do not remove the AC adapter while the internal mass is in motion, for example, right after the AC adapter is connected, or during calibration using the internal mass.
If the AC adapter is removed under the conditions described above, the internal mass will be left unsecured, that may cause mechanical damage when the balance is moved.
Before removing the AC adapter, press the **ON:OFF** key and confirm that zero is displayed.
- When the AC adapter is connected, the balance is in the standby mode if the standby indicator is on (refer to “3-5 Display Symbols and Key Operation”). This is a normal state and does not

harm the balance. For accurate weighing, warm up the balance for at least 30 minutes before use.

3-5 Display Symbols and Key Operation

Key operation

Key operation affects how the balance functions. The basic key operations are:

- “Press and release the key immediately” or “Press the key”
= normal key operation during measurement
- “Press and hold the key”

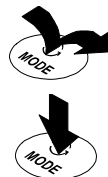

Display symbols

- Displays data stored in memory
- Displays the weighing data relative to the weighing capacity, in percentage, in the weighing mode (**Capacity indicator**)

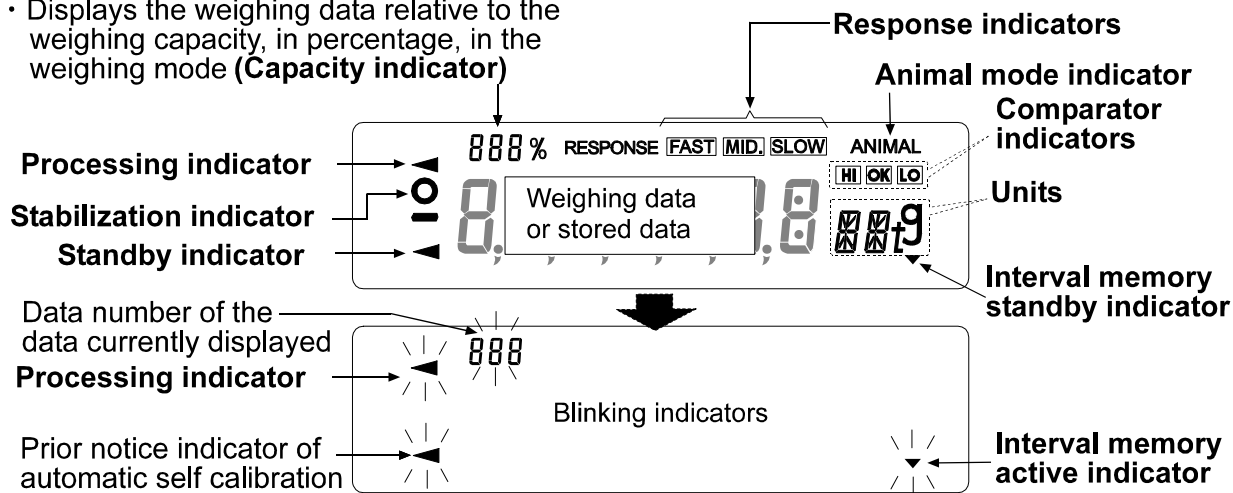

Each key, when pressed or when pressed and held, functions as follows:

Key	When pressed	When pressed and held
	Turns the display on and off. The standby indicator is displayed when the display is turned off. The weighing mode is enabled when the display is turned on. This key is available anytime. Pressing the key during operation will interrupt the operation and turn the display off.	
	In the weighing mode, turns the minimum weighing value on and off. In the counting or percent mode, enters the sample storing mode.	Enters the function table mode. Refer to “9. FUNCTION TABLE”.
	Switches the weighing units stored in the function table. Refer to “4. WEIGHING UNITS”.	Performs response adjustment and self check.
	Performs calibration of the balance using the internal mass.	Displays other items of the calibration menu.
	Stores the weighing data in memory or outputs to a printer or personal computer using the RS-232C interface (Factory setting), depending on the function table	No function at the factory setting By changing the function table: Outputs “Title block” and “End block” for

	settings.	GLP report. Displays the data memory menu.
	Sets the display to zero.	

4. WEIGHING UNITS

4-1 Units

With the GX series balance, the following weighing units and weighing modes are available :

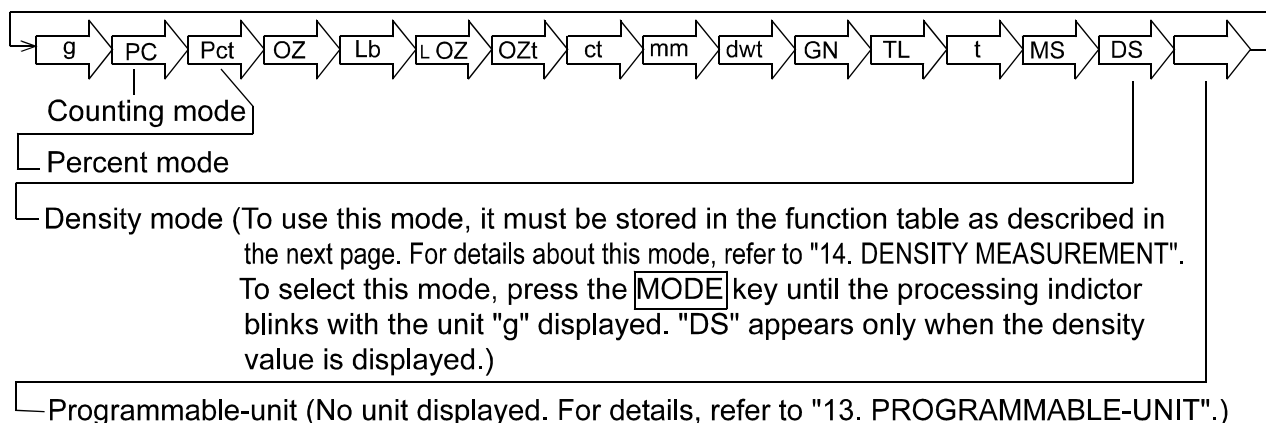



A unit or mode can be selected and stored in the function table as described on page 13.

If a weighing mode (or unit of weight) has been turned off, that mode or unit will be missing in the sequence. Tael has four varieties, one of which can be selected and installed at the factory.

To select a unit or mode for weighing, press the **MODE** key.

For details about the units and modes, see the table below:

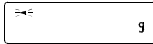
Name (unit, mode)	Abbrev.	Display	Function table (Storing mode)	Conversion factor 1 g =
Gram	g	g	g	1 g
Counting mode	PC	PC	PC	—
Percent mode	Pct	Pct	Pct	—
Ounce (Avoir)	OZ	OZ	OZ	28.349523125 g
Pound	Lb	Lb	Lb	453.59237 g
Pound/Ounce	L OZ	L OZ	LO	1Lb=16 oz, 1 oz=28.349523125 g
Troy Ounce	OZt	OZt	OZt	31.1034768 g
Metric Carat	ct	ct	ct	0.2 g
Momme	mm	mm	mm	3.75 g
Pennyweight	dwt	dwt	dwt	1.55517384 g
Grain (UK)	GN	GN	GN	0.06479891 g
Tael (HK general, Singapore)	TL	TL	TL	37.7994 g
Tael (HK jewelry)				37.429 g
Tael (Taiwan)				37.5 g
Tael (China)				31.25 g
Tola (India)	t	t	t	11.6638038 g
Messghal	MS	MS	MS	4.6875 g

Density mode (See note below)	DS	 g DS is used to show the density.		—
Programmable-unit (Multi-unit)	MIt	—	ML t	—

Note: The blinking processing indicator with “g” indicates that the density mode is selected.

The tables below indicate the weighing capacity and the minimum display for each unit, depending on the balance model.

Unit	GX-200	GX-300	GX-400	GX-600	GX-800	GX-1000	Minimum display
	Capacity						
Gram	210.000	310.000	410.000	610.000	810.000	1100.000	0.001
Ounce (Avoir)	7.40755	10.93495	14.46230	21.51710	28.57190	38.80135	0.00005
Pound	0.462970	0.683435	0.903895	1.344820	1.785745	2.425085	0.000005
Pound/Ounce	0Lb 7.41oz	0Lb 10.93oz	0Lb 14.46oz	1Lb 5.52oz	1Lb 12.57oz	2Lb 6.80oz	0.01oz
Troy Ounce	6.75165	9.96675	13.18180	19.61195	26.04210	35.36580	0.00005
Metric Carat	1050.000	1550.000	2050.000	3050.000	4050.000	5500.000	0.005
Momme	56.0000	82.6665	109.3335	162.6665	216.0000	293.3335	0.0005
Pennyweight	135.033	199.335	263.636	392.239	520.842	707.316	0.001
Grain (UK)	3240.80	4784.04	6327.26	9413.74	12500.22	16975.60	0.02
Tael (HK general, Singapore)	5.55565	8.20120	10.84675	16.13780	21.42890	29.10100	0.00005
Tael (HK jewelry)	5.61060	8.28235	10.95405	16.29750	21.64095	29.38900	0.00005
Tael (Taiwan)	5.60000	8.26665	10.93335	16.26665	21.60000	29.33335	0.00005
Tael (China)	6.72000	9.92000	13.12000	19.52000	25.92000	35.20000	0.00005
Tola (India)	18.0044	26.5780	35.1515	52.2985	69.4456	94.3089	0.0001
Messghal	44.8000	66.1335	87.4665	130.1335	172.8000	234.6665	0.0005

Unit	GX-2000	GX-3000	GX-4000	GX-6100	Minimum display
	Capacity				
Gram	2100.00	3100.00	4100.00	6100.00	0.01
Ounce (Avoir)	74.0755	109.3495	144.6230	215.1710	0.0005
Pound	4.62970	6.83435	9.03895	13.44820	0.00005
Pound/Ounce	4Lb 10.08oz	6Lb 13.35oz	9Lb 0.62oz	13Lb 7.17oz	0.01oz
Troy Ounce	67.5165	99.6675	131.8180	196.1195	0.0005
Metric Carat	10500.00	15500.00	20500.00	30500.00	0.05
Momme	560.000	826.665	1093.335	1626.665	0.005
Pennyweight	1350.33	1993.35	2636.36	3922.39	0.01
Grain (UK)	32408.0	47840.4	63272.6	94137.4	0.2
Tael (HK general, Singapore)	55.5565	82.0120	108.4675	161.3780	0.0005
Tael (HK jewelry)	56.1060	82.8235	109.5405	162.9750	0.0005
Tael (Taiwan)	56.0000	82.6665	109.3335	162.6665	0.0005

Tael (China)	67.2000	99.2000	131.2000	195.2000	0.0005
Tola (India)	180.044	265.780	351.515	522.985	0.001
Messghal	448.000	661.335	874.665	1301.335	0.005

Unit	GX-6000	GX-8000	Minimum display
	Capacity		
Gram	6100.0	8100.0	0.1
Ounce (Avoir)	215.170	285.720	0.005
Pound	13.4480	17.8575	0.0005
Pound/Ounce	13Lb 7.17oz	17Lb 13.72oz	0.01oz
Troy Ounce	196.120	260.420	0.005
Metric Carat	30500.0	40500.0	0.5
Momme	1626.65	2160.00	0.05
Pennyweight	3922.4	5208.4	0.1
Grain (UK)	94136	125002	2
Tael (HK general, Singapore)	161.380	214.290	0.005
Tael (HK jewelry)	162.975	216.410	0.005
Tael (Taiwan)	162.665	216.000	0.005
Tael (China)	195.200	259.200	0.005
Tola (India)	522.99	694.46	0.01
Messghal	1301.35	1728.00	0.05

4-2 Storing Units

The units or modes can be selected and stored in the function table. The sequence of displaying the units or modes can be arranged so as to fit the frequency of use in the function table.

Select a unit or mode and arrange the sequence of display as follows:

- 1 Press and hold the **SAMPLE** key until **bRSFnC** of the function table is displayed.
- 2 Press the **SAMPLE** key several times to display **Unit**.
- 3 Press the **PRINT** key to enter the unit selection mode.
- 4 Specify a unit or mode in the order to be displayed using the following keys.

SAMPLE key To sequentially display the units.

RE-ZERO key To specify a unit or mode. The stabilization indicator appears when the displayed unit or mode is specified.

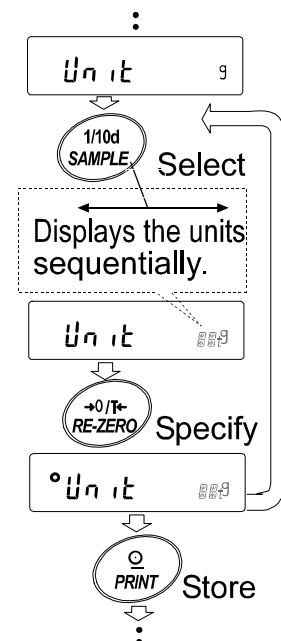

- 5 Press the **PRINT** key to store the units or modes. The balance displays **End** and then displays the next menu of the function table.
- 6 Press the **CAL** key to exit the function table. Then the balance returns to the weighing mode with the selected unit.
- 7 To select other unit or mode for weighing, press the **MODE** key.

5. WEIGHING

5-1 Basic Operation (Gram Mode)

- 1 Place a container on the weighing pan, if necessary.
Press the **RE-ZERO** key to cancel the weight (tare). The balance displays **0.00 g**. (The decimal point position depends on the balance model.)
- 2 Place a sample on the pan or in the container.
- 3 Wait for the stabilization indicator to be displayed. Read the value.
- 4 Remove the sample and container from the pan.

Notes

To use other units, press the **MODE** key and select an appropriate unit.

Press the **SAMPLE** key to turn on or off the minimum weighing value.

The weighing data can be stored in memory. For details, refer to "11. DATA MEMORY".

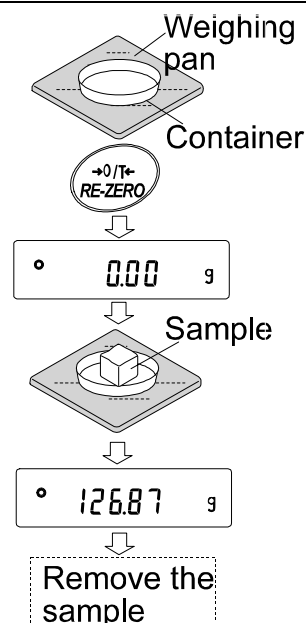

When the **ON:OFF** key is pressed with a container placed on the weighing pan and weighing is started, the balance automatically cancels the weight (tare) and displays **0.00 g**.

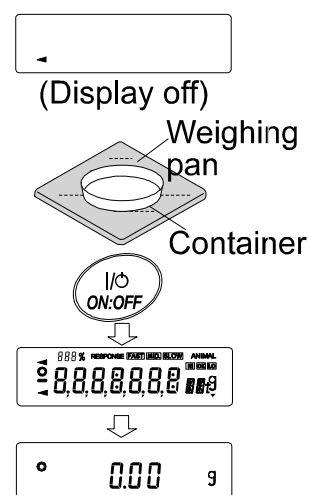

5-2 Counting Mode (PC)

This is the mode to determine the number of objects in a sample based on the standard sample unit mass. Unit mass means the mass of one sample. The smaller the variables in each sample unit mass is, the more accurate the counting will be. The GX series balance is equipped with the Automatic Counting Accuracy Improvement (ACAI) function to improve the counting accuracy.

Note

If the sample unit mass variable is too large, it may cause a counting error.

Selecting the counting mode

- 1 Press the **MODE** key to select **PC** (counting mode).

Storing a sample unit mass

- 2 Press the **SAMPLE** key to enter the sample unit mass storing mode.
Even in the storing mode, pressing the **MODE** key will switch to the next mode.
- 3 To select the number of samples, press the **SAMPLE** key several times. It may be set to 10, 25, 50 or 100.

Note

A greater number of samples will yield more accurate counting result.

- 4 Place a container on the weighing pan, if necessary. Press the **RE-ZERO** key to cancel the weight (tare). The number specified in step 3 appears.
e.g.: **25 0 PC** is displayed if 25 is selected in step 3.
- 5 Place the number of samples specified on the pan. In this example, 25 pieces.
- 6 Wait for the stabilization indicator to come on. Press the **PRINT** key to calculate and store the unit mass. The balance displays **25 PC** (counting mode) and is set to count samples with this unit mass. (The sample unit mass stored, even if the AC adapter is removed, is maintained in non-volatile memory.)

To improve the accuracy of the unit mass, proceed to step 8.

Notes

If the balance judges that the mass of the samples is too light and is not adequate to be used as the unit mass, it displays **Lo**. Do not use the samples.

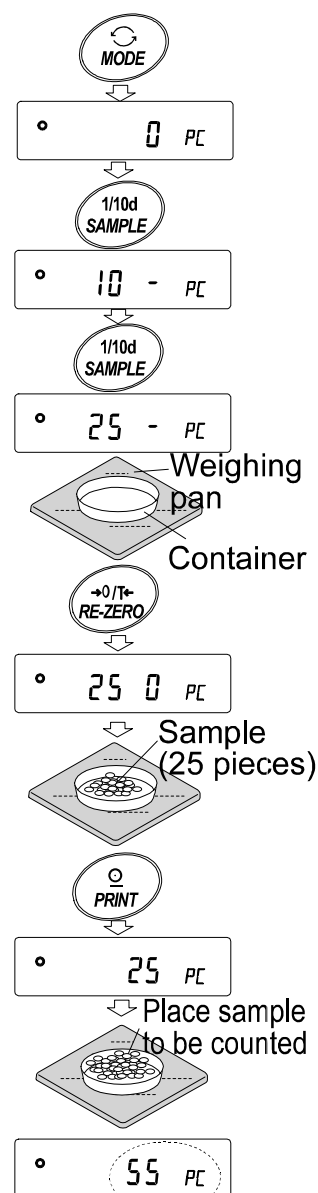

The counting result

If the balance judges that the mass of the samples is too light to acquire accurate weighing, it displays an error requiring the addition of more samples to the specified number. In the example above, **50-PC** appears, requiring 25 more samples. Add 25 samples and press the **PRINT** key. When the unit mass is stored correctly, the balance proceeds to the counting mode.

Counting operation

- 7 Place the samples to be counted on the pan.

Note

Up to 20 unit masses can be stored in memory for the multiple sample. For details, refer to "11. DATA MEMORY".

Counting mode using the ACAI function

The ACAI is a function that improves the accuracy of the unit mass automatically by increasing the number of samples as the counting process proceeds.

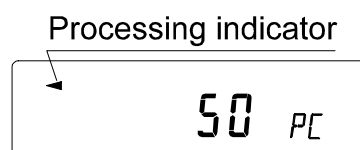

- 8 If a few more samples are added, the processing indicator turns on. To prevent an error, add three or more. The processing indicator does not turn on if overloaded. Try to add the same number of samples as displayed.
- 9 The balance re-calculates the unit mass while the processing indicator is blinking. Do not touch the balance or samples on the pan until the processing indicator turns off.
- 10 Counting accuracy is improved when the processing indicator turns off.
Each time the above operation is performed, a more accurate unit mass will be obtained. There is no definite upper limit of ACAI range for the number of samples exceeding 100. Try to add the same number of samples as displayed.
- 11 Remove all the samples used in ACAI and proceed with the counting operation using the improved unit mass.

5-3 Percent Mode (Pct)

This is the mode to display the weight value in percentage compared to a 100% reference mass and is used for target weighing or checking the sample variable.

Selecting the percent mode

- 1 Press the **MODE** key to select **Pct** (percent mode). If the percent mode can not be selected, refer to “4. WEIGHING UNITS”.

Storing the 100% reference mass

- 2 Press the **SAMPLE** key to enter the 100% reference mass storing mode.

Even in the storing mode, pressing the **MODE** key will switch to the next mode.

- 3 Place a container on the weighing pan, if necessary. Press the **RE-ZERO** key to cancel the weight (tare). The balance displays **100 0 Pct**.
- 4 Place the sample to be set as the 100% reference mass on the pan or in the container.
- 5 Press the **PRINT** key to store the reference mass. The balance displays **10000 Pct**. (The decimal point position depends on the reference value. The reference mass stored, even if the AC adapter is removed, is maintained in non-volatile memory.)

Note

If the balance judges that the mass of the sample is too light to be used as a reference, it displays **Lo**. Do not use the sample.

- 6 Remove the sample.

Reading the percentage

- 7 Place a sample to be compared to the reference mass on the pan. The displayed percentage is based on the 100% reference mass.

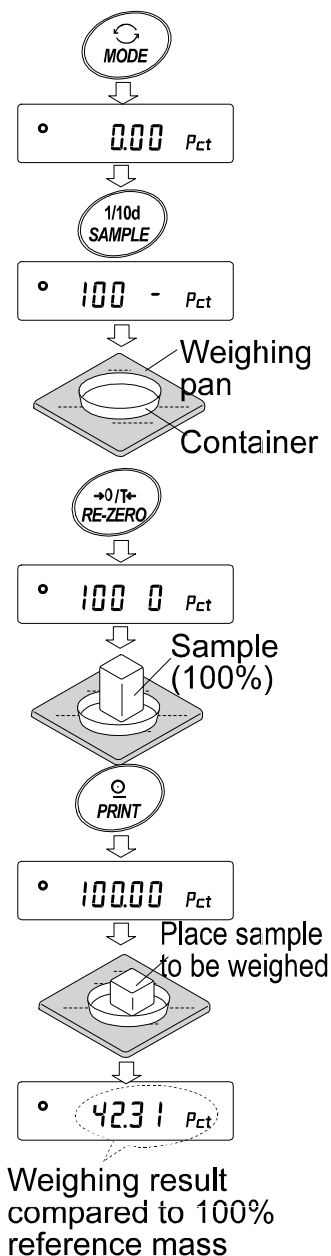

5-4 Animal Weighing Mode (Hold Function)

This is the mode to weigh a moving object such as an animal, even when the display of the weighing data fluctuates. The hold function allows the average weight of the animal to be displayed.

To use the hold function, set the function in the function table. For details, refer to “9. FUNCTION TABLE” and “9-4 Description of the Class “Environment, Display””.

6. RESPONSE ADJUSTMENT / SELF CHECK FUNCTION

This function detects the influence on weighing that is caused by drafts and/or vibration at the place where the balance is installed and sets the response characteristic automatically. When this function is selected, the balance self-checks the performance at the same time.

Two modes of response adjustment are available: automatic and manual.

The function has three rates as follows:

Response indicators



Changing the response rate changes the display refresh rate.

Indicator	Parameter	Response characteristic	Display refresh rate
FAST	[and 0]	Fast response, Sensitive value ↑ ↓	If the response rate is changed as follows: MID. or SLOW → FAST = 10 times/second FAST → MID. or SLOW = 5 times/second
MID.	[and 1]		
SLOW	[and 2]		

Note

To set the refresh rate of 5 times/second when the response rate is FAST or 10 times/second when the response rate is MID. or SLOW, change the “Display refresh rate (SPd)” parameter of “Environment, Display (bASFnc)” in the function table. For details, refer to “9. FUNCTION TABLE”.

6-1 Automatic Response Adjustment / Self Check Function

This function automatically updates the response adjustment by analyzing the influence of the environment on the weighing data and also self-checks the balance performance using the internal mass.

Operation

- 1 Press and hold the **MODE** key until **RESPONSE** is displayed, and then release the key.
- 2 The balance automatically starts to check the balance performance and sets the response characteristic.

Caution

Do not allow vibration or drafts to affect the balance during adjustment.

- 3 After automatic adjustment, the balance displays the updated response indicator and returns to the weighing mode. The response indicator remains displayed for a while.

e.g. “**MID.** **OK**”

The example above indicates that the result of the self check is good and **MID.** is selected as the response rate.

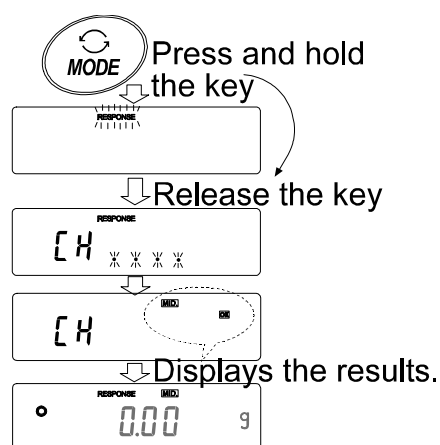

Notes

If improper performance is found in the self check, the balance displays $[CH\ n0]$. Contact the local A&D dealer for repair.

If the automatic response adjustment fails, the balance displays $[CH\ n0]$. Check the ambient conditions such as breeze and vibration, also check the weighing pan. Then, perform the adjustment again. To return to the weighing mode, press the $[CAL]$ key.

If the automatic response adjustment is awkward, try to refine it using the manual response adjustment.

6-2 Manual Response Adjustment

This function manually updates the response adjustment.

Operation

- 1 Press and hold the $[MODE]$ key until $[RESPONSE]$ is displayed.
And then, press the $[MODE]$ key again quickly.
- 2 Press the $[MODE]$ key to select a rate of the response adjustment. Either $[FAST]$, $[MID]$, or $[SLOW]$ can be selected.
- 3 After a few seconds of inactivity the balance displays $[End]$. Then, it returns to the weighing mode and displays the updated response indicator. The response indicator remains displayed for a while.

Note

The response adjustment can be changed at “Condition ($[Cond]$)” of “Environment, Display ($bASFnc$)” in the function table. For details, refer to “9. FUNCTION TABLE”.

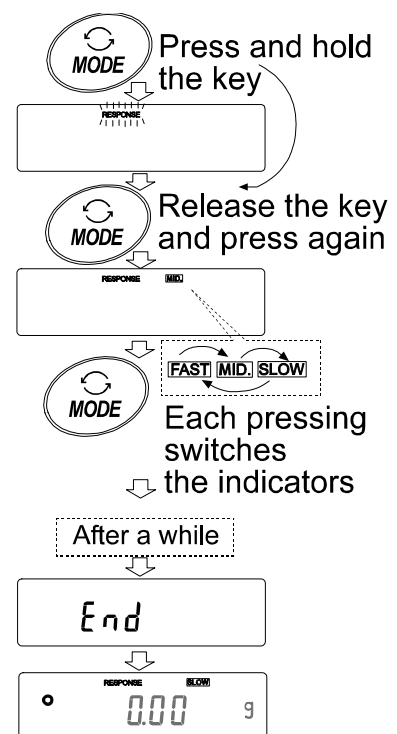

7. CALIBRATION

7-1 Calibration Group

The GX series balance has the following modes as a calibration group.

- Calibration
 - Automatic self calibration (calibration due to changes in temperature)
 - Calibration using the internal mass (one-touch calibration)
 - Calibration using an external weight
- Calibration test
 - Calibration test using an external weight (Calibration test does not perform calibration.)
- Correction of the internal mass value

Terms

The following terms are defined as follows:

- Internal mass = Built-in calibration weight
- External weight = A weight that you have. Referred to as a calibration weight when used for calibration.
- Calibration weight = A weight used for calibration
- Target weight = An external weight used for calibration test

Caution

- Calibration adjusts the balance for accurate weighing.
Besides periodic calibration and before each use, perform calibration when:
 - the balance is installed for the first time.
 - the balance has been moved.
 - the ambient environment has changed.
- Do not allow vibration or drafts to affect the balance during calibration.
- To output the data for GLP using the RS-232C interface, set “GLP output (*inF0*)” of “Data output (*dout*)”. For details, refer to “9. FUNCTION TABLE”. Time and date are added to GLP report. If the time or date is not correct, adjust them. For details, refer to “9-9 Clock and Calendar Function”.
- Calibration test is available only when “GLP output (*inF0*)” of “Data output (*dout*)” is set to “1” or “2”.
- The calibration and calibration test data can be stored in memory. To store them, set “Data memory (*DATA*)” to “3”. For details, refer to “11. DATA MEMORY”.

Caution on using an external weight

- The accuracy of an external weight can influence the accuracy of weighing. Select an appropriate weight as listed below:

Model	Usable calibration weight	Adjustable range
GX-200	200 g , 100 g	-0.015 g to +0.015 g
GX-300	300 g, 200 g , 100 g	
GX-400	400 g , 300 g, 200 g	
GX-600	600 g, 500 g , 400 g, 300 g, 200g	
GX-800	800 g, 700 g, 600 g, 500 g , 400 g, 300 g, 200g	
GX-1000	1000g , 900g, 800 g, 700 g, 600 g, 500 g, 400 g, 300 g, 200g	
GX-2000	2000 g , 1000 g	-0.15 g to +0.15 g
GX-3000	3000 g, 2000 g , 1000 g	
GX-4000	4000 g , 3000 g, 2000 g	
GX-6100	6000 g, 5000 g , 4000 g, 3000 g, 2000g	
GX-6000	6000 g, 5000 g , 4000 g, 3000 g, 2000g	-1.5 g to +1.5 g
GX-8000	8000 g, 7000 g, 6000 g, 5000 g , 4000 g, 3000g, 2000g	

The calibration weight in bold type: factory setting

The calibration weight value can be adjusted within the range above.

Display



- This indicator means “the balance is measuring calibration data”. Do not allow vibration or drafts to affect the balance while this indicator is displayed.

7-2 Automatic Self Calibration (Calibration due to changes in temperature)

This function automatically calibrates the balance when the balance detects an ambient temperature change. If GLP output is selected in the function table, the balance outputs the calibration report or stores the data in memory. Automatic self calibration functions even if the display is turned off (standby state).

Caution

If something is on the weighing pan, the balance judges that it is in use and does not perform automatic self calibration. To maintain the calibrated state, keep the weighing pan clear while not in use.

The displays shown below are related to the automatic self calibration.



Indicates that the balance detects a change in ambient temperature and automatic self calibration will start. If the balance is not used for a few minutes with this indicator blinking, the balance performs automatic self calibration. The blinking duration depends on the environment.

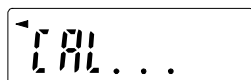

Indicates that the balance is measuring calibration data. Do not allow vibration or drafts to affect the balance while this indicator is displayed. After calibration, the balance returns to indicate the previous display.

Note

The balance can be used while the indicator blinks. But, it is recommended that to maintain the accuracy, stop using the balance and confirm that there is nothing on the pan and allow the balance to perform self calibration.

7-3 Calibration Using the Internal mass (One-Touch Calibration)

This function calibrates the balance using the internal mass. The only operation required is to press the **CAL** key.

Operation

- 1 Connect the AC adapter and warm up the balance for at least 30 minutes with nothing on the weighing pan.
- 2 Press the **CAL** key.
- 3 The balance displays **ERR in** and performs calibration using the internal mass. Do not allow vibration or drafts to affect the balance.
- 4 The balance displays **End** after calibration. If the “GLP output (inFa)” parameter of the function table is set to “1” or “2”, the balance displays **GLP** and outputs “Calibration Report” using the RS-232C interface or stores the data in memory. For details on the calibration report format, refer to “10-2 GLP Report”.
- 5 The balance will automatically return to the weighing mode after calibration.

About the internal mass

The mass of the internal mass (approximately 500 g) may change due to corrosion or other damage caused by the operating environment, or due to aging. Check the internal mass periodically. Correct the internal mass value as necessary. For details, refer to “7-6 Correcting the internal mass value”.

To maintain the weighing accuracy, perform the calibration using an external weight periodically, as described below.

7-4 Calibration Using an External Weight

This function calibrates the balance using an external weight.

Operation

- 1 Connect the AC adapter and warm up the balance for at least 30 minutes with nothing on the pan.
- 2 Press and hold the **[CAL]** key until **[CALout]** is displayed, and then release the key.
- 3 The balance displays **[CAL 0]**.
 - If you want to change the calibration weight (a list of usable weights is shown on page 20), press the **[SAMPLE]** key and proceed to step 4.
 - If you use the calibration weight value stored in the balance, proceed to step 5.
- 4 Specify the calibration weight value as follows:

[SAMPLE] key To switch the display condition to: "All of the segments blinking" (calibration weight selection mode) or "The last two digits blinking" (value adjustment mode).

[RE-ZERO] key To select the calibration weight or adjust the value. In the value adjustment mode, -15 digits appear after +15 digits.

[PRINT] key To store the new weight value. Even if the AC adapter is removed, the data is maintained in non-volatile memory.

[CAL] key To cancel the operation and return to **[CAL 0]**.

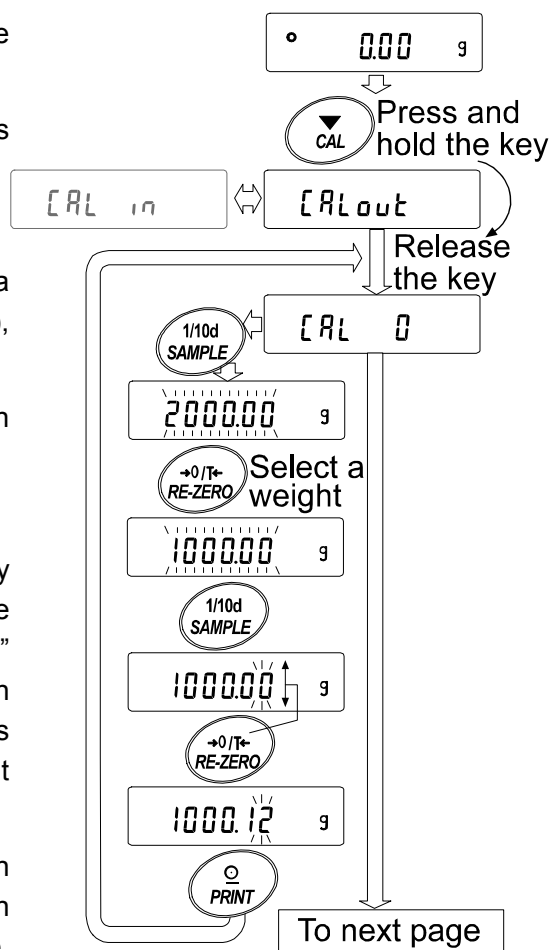

e.g. Calibration weight value
1000.12 g

Note

Digit, when used for the GX series balance, indicates a unit of minimum weighing value.

- 5 Confirm that there is nothing on the pan and press the **PRINT** key. The balance measures the zero point. Do not allow vibration or drafts to affect the balance.
The balance displays the calibration weight value.
- 6 Place the displayed calibration weight on the pan and press the **PRINT** key. The balance measures the calibration weight. Do not allow vibration or drafts to affect the balance.
- 7 The balance displays **End**. Remove the weight from the pan.
- 8 If the “GLP output (INF0)” parameter, of the function table, is set to “1” or “2”, the balance displays **GLP** and outputs “Calibration Report” using the RS-232C interface or stores the data in memory. For details on the calibration report format, refer to “10-2 GLP Report”.
- 9 The balance will automatically return to the weighing mode.
- 10 Place the calibration weight on the pan and confirm that the value displayed is within ± 2 digits of the specified value. If it is not within the range, check the ambient conditions such as breeze and vibration, also check the weighing pan. Then, repeat steps 1 to 10.

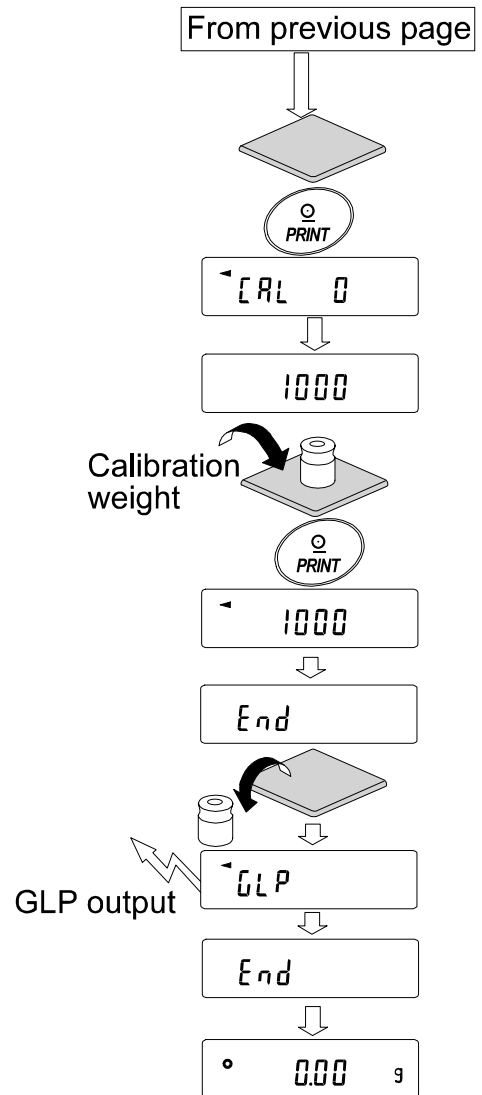

7-5 Calibration Test Using an External Weight

This function tests the balance weighing accuracy using an external mass and outputs the result. This is available only when the “GLP output (INF0)” parameter is set to “1” or “2”. (Calibration test does not perform calibration.)

Operation

- 1 Connect the AC adapter and warm up the balance for at least 30 minutes with nothing on the pan.
- 2 Press and hold the **CAL** key until **[[out** is displayed, and then release the key.
- 3 The balance displays **[[0**.
 - If you want to change the target weight (a list of usable weights is shown on page 20), press the **SAMPLE** key and proceed to step 4.
 - If you use the target weight value stored in the balance, proceed to step 5.
- 4 Specify the target weight value as follows:

SAMPLE key To switch the display condition to: “All of the segments blinking” (target weight selection mode) or “The last two digits blinking” (value adjustment mode).

RE-ZERO key To select the target weight or adjust the value. In the value adjustment mode, -15 digits appear after +15 digits.

PRINT key To store the new weight value. Even if the AC adapter is removed, the data is maintained in non-volatile memory.

CAL key To cancel the operation and return to **[[0**.

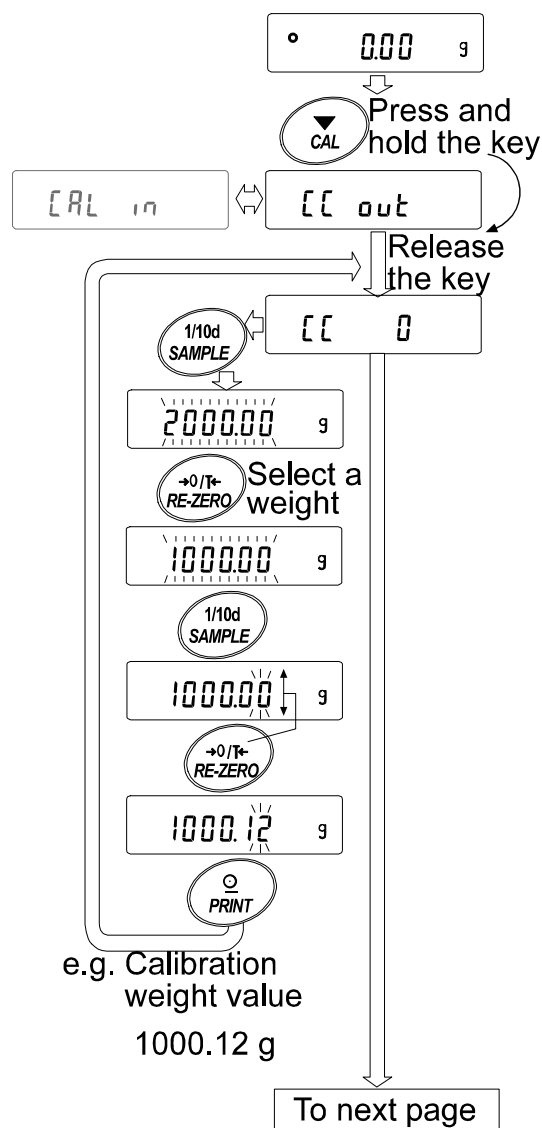

Note

Digit, when used for the **GX** series balance, indicates a unit of minimum weighing value.

- 5 Confirm that there is nothing on the pan and press the **PRINT** key. The balance measures the zero point and displays the measured value. Do not allow vibration or drafts to affect the balance.
The balance displays the target weight value.
- 6 Place the displayed target weight on the pan and press the **PRINT** key. The balance measures the target weight and displays the measured value. Do not allow vibration or drafts to affect the balance.
- 7 The balance displays **End**. Remove the weight from the pan.
- 8 The balance displays **GLP** and outputs “Calibration Test Report” using the RS-232C interface or stores the calibration test data in memory. For details on the calibration test report format, refer to “10-2 GLP Report”.
- 9 The balance will automatically return to the weighing mode.

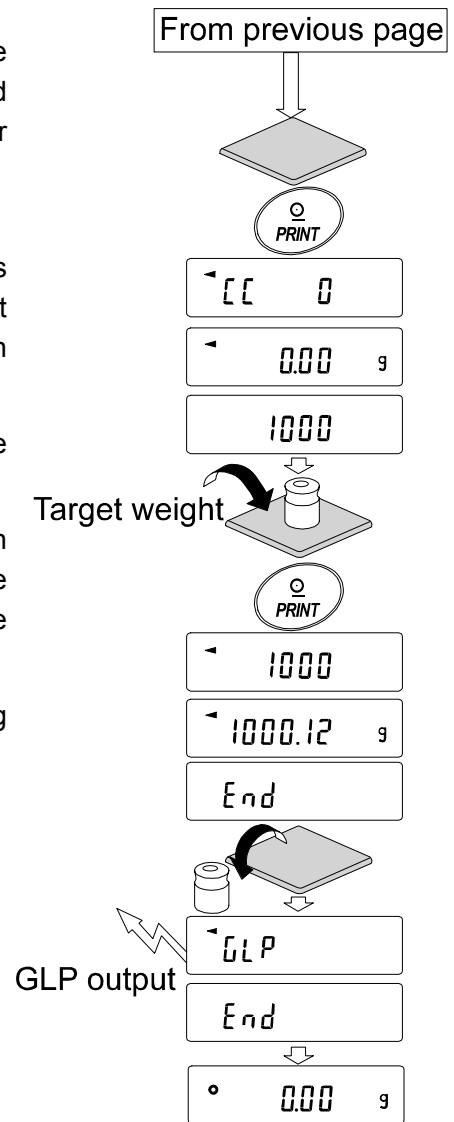

7-6 Correcting the Internal Mass Value

The GX series balance can correct the internal mass value within the range shown below. This function corrects the internal mass value to conform to an external weight. The corrected mass value is maintained in non-volatile memory even if the AC adapter is removed.

The internal mass value is corrected as follows:

Model	Correction reference value	Correction range
GX-200	200.000 g	-0.020 g to +0.020 g
GX-300		
GX-400	400.000 g	
GX-600	500.000 g	
GX-800		
GX1000		
GX-2000	2000.00 g	-0.20 g to +0.20 g
GX-3000		
GX-4000		
GX-6100		
GX-6000	2000.0 g	-2.0 g to +2.0 g
GX-8000		

Example: Using the GX-400

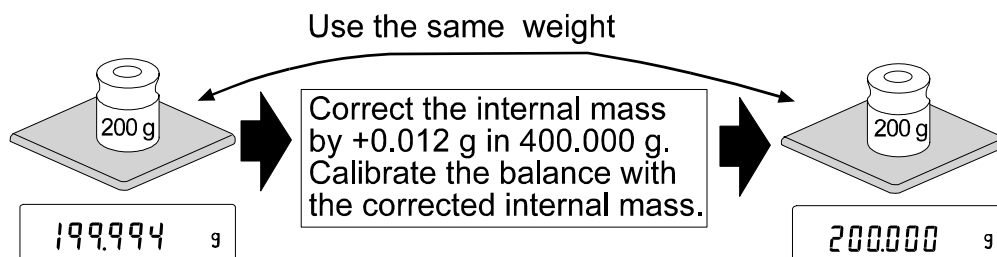

Operation

- 1 Calibrate the balance using the internal mass (one-touch calibration). Then, place an external weight and confirm the value to be corrected.

In the example, the value is off by -0.006 gram and the correction reference value of the GX-400 is 400 grams. So, the value is to be corrected by 0.012 gram in 400.000 grams.

- 2 Press the **ON:OFF** key to turn off the display.
- 3 While pressing and holding the **PRINT** key and the **SAMPLE** key, press the **ON:OFF** key. The balance displays **P5**.
- 4 Press the **PRINT** key. Then the balance displays the function switches.

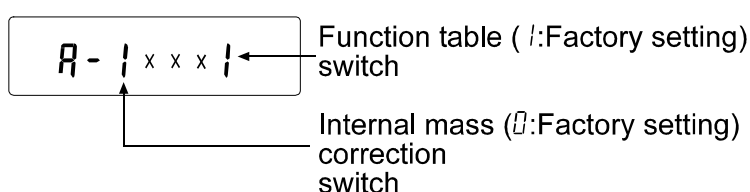

Set the function table switch and internal mass correction switch to "1" as shown above using the following keys.

- SAMPLE** key To select the switch to change the value.
- RE-ZERO** key To change the parameter of the switch selected.

- 5 Press the **PRINT** key to store the new setting. The balance returns to the weighing mode.
- 6 Press and hold the **SAMPLE** key to enter the function table and release the key when **bR5FnC** is displayed.
- 7 Press the **SAMPLE** key several times until **LS in** is displayed.
- 8 Press the **PRINT** key to enter the procedure for correcting the internal mass value.
- 9 Correct the internal mass value using the following keys.
 - RE-ZERO** key To select the value.
(-20 digits appear after +20 digits.)
 - PRINT** key To store the new value and display the next menu of the function table.
 - CAL** key To cancel the correction and display the next menu of the function table.
- 10 Press the **CAL** key. The balance returns to the weighing mode.
- 11 Press the **CAL** key to calibrate the balance using the internal mass.
- 12 Place the external weight on the pan and confirm that the correction has been performed properly. In this example, confirm that the value displayed is within ± 2 digits of 200.000 grams, or within ± 0.002 gram.

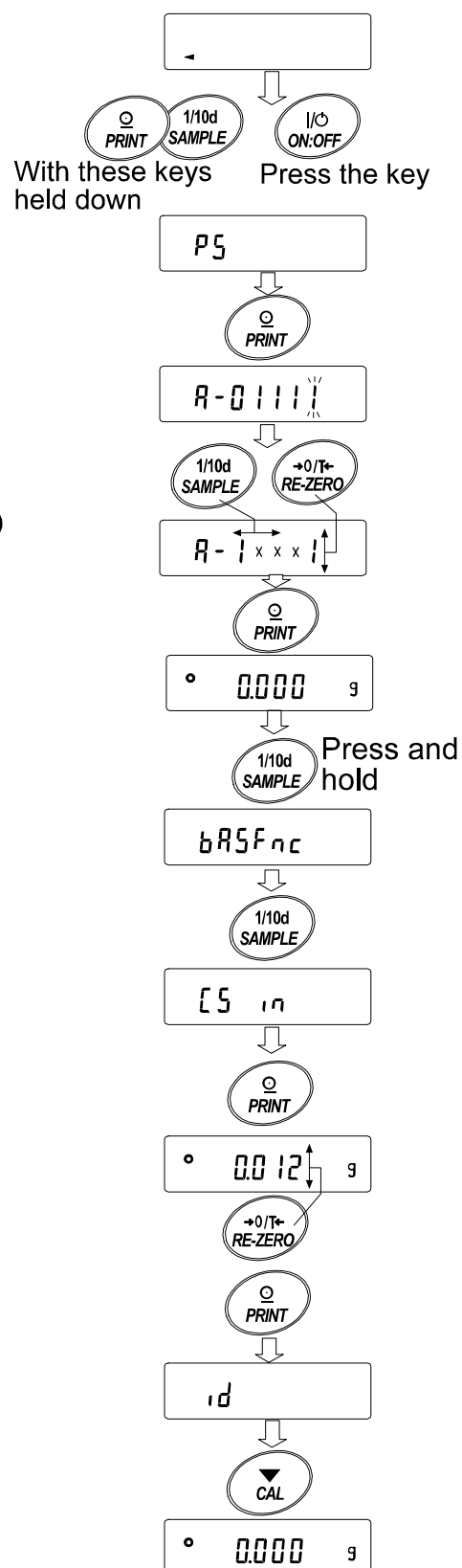

8. FUNCTION SWITCH AND INITIALIZATION

8-1 Permit or Inhibit

The balance stores parameters that must not be changed carelessly (e.g. Calibration data for accurate weighing, Data for adapting to the operating environment, Control data for the RS-232C interface). There are five switches for the purpose of protecting these parameters. Each switch can select either “permit” or “inhibit”. The “inhibit” protects parameters against careless operations.

Switches

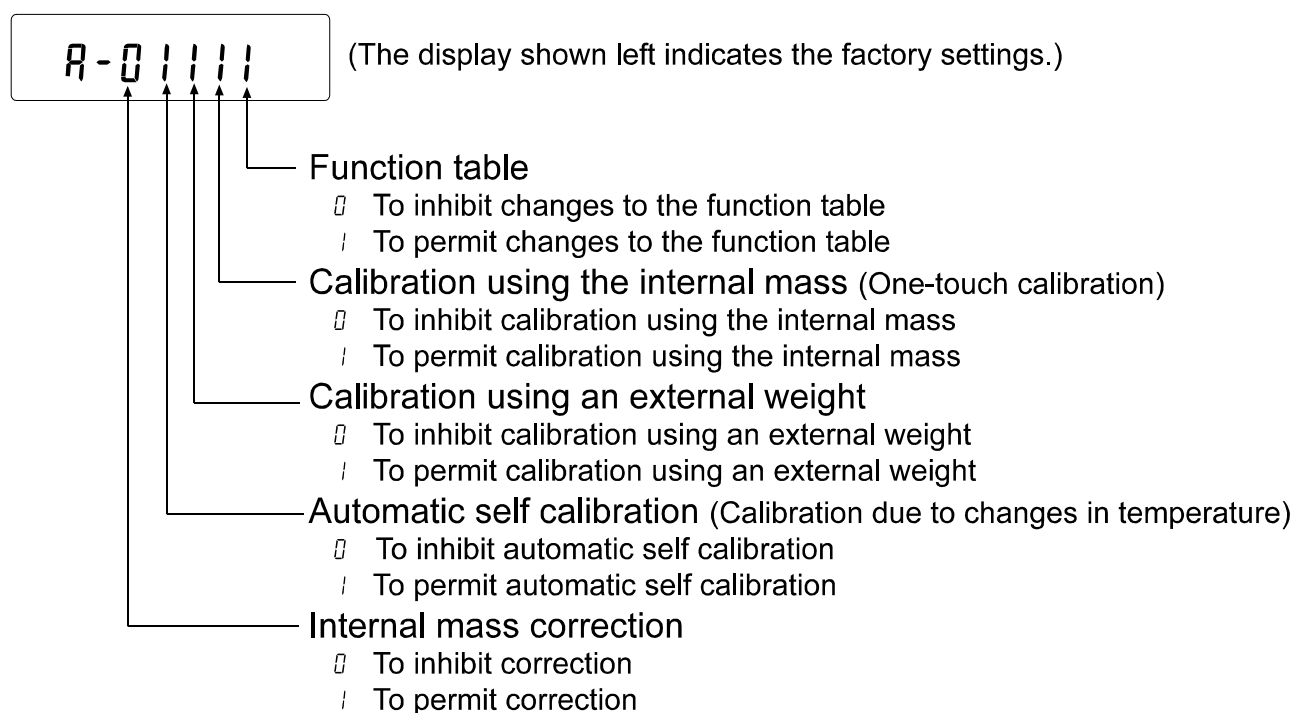

Operation

- 1 Press the **ON:OFF** key to turn off the display.
- 2 While pressing and holding the **PRINT** key and the **SAMPLE** key, press the **ON:OFF** key. The balance displays **PS**.
- 3 Press the **PRINT** key. Then the balance displays the function switches.
- 4 Set the switches using the following keys.

SAMPLE key	To select the switch to change the parameter.
RE-ZERO key	To change the parameter of the switch selected.
	□:To inhibit changes. !:To permit changes
PRINT key	To store the new parameter and return to the weighing mode.
CAL key	To cancel the operation. (ELr is displayed.)
	To return to the weighing mode, press CAL key once again.

8-2 Initializing the Balance

This function returns the following parameters to factory settings.

- Calibration data
- Function table
- The sample unit mass value (counting mode), 100% reference mass value (percent mode)
- The data that is stored in the balance using the data memory function
- External calibration weight and target weight value
- Function switch settings
- Liquid density and temperature in the density mode

Note

Be sure to calibrate the balance after initialization.

Operation

- 1 Press the **ON:OFF** key to turn off the display.
- 2 While pressing and holding the **PRINT** key and the **SAMPLE** key, press the **ON:OFF** key. The balance displays **P5**.
- 3 Press the **SAMPLE** key to display **[Lr]**.
- 4 Press the **PRINT** key.
To cancel this operation, press the **CAL** key.
- 5 Press the **RE-ZERO** key.
- 6 Press the **PRINT** key to initialize the balance.

The balance will automatically return to the weighing mode.

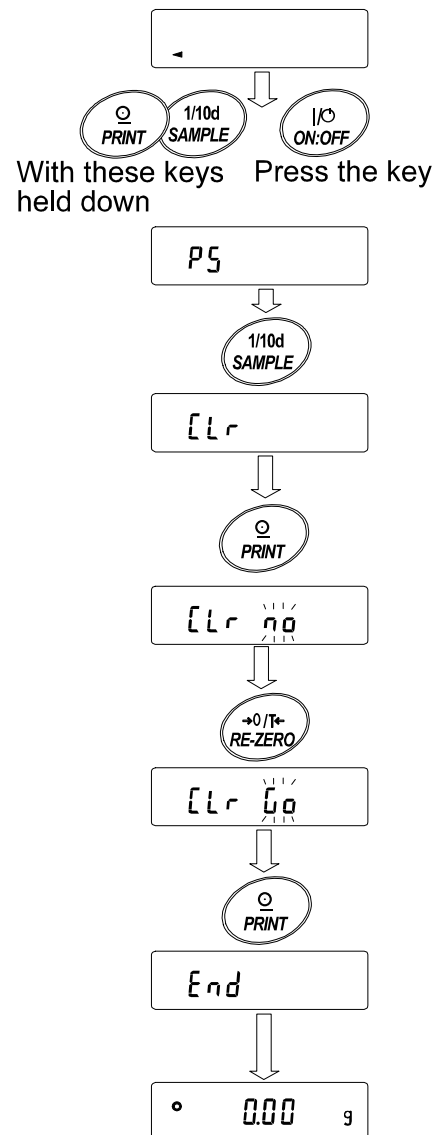

9. FUNCTION TABLE

The function table reads or rewrites the parameters that are stored in the balance. These parameters stored, even if the AC adapter is removed, are maintained in non-volatile memory.

9-1 Structure and Sequence of the Function Table

The function table menu consists of two layers. The first layer is the “Class” and the second layer is the “Item”. Each item stores a parameter.

Example

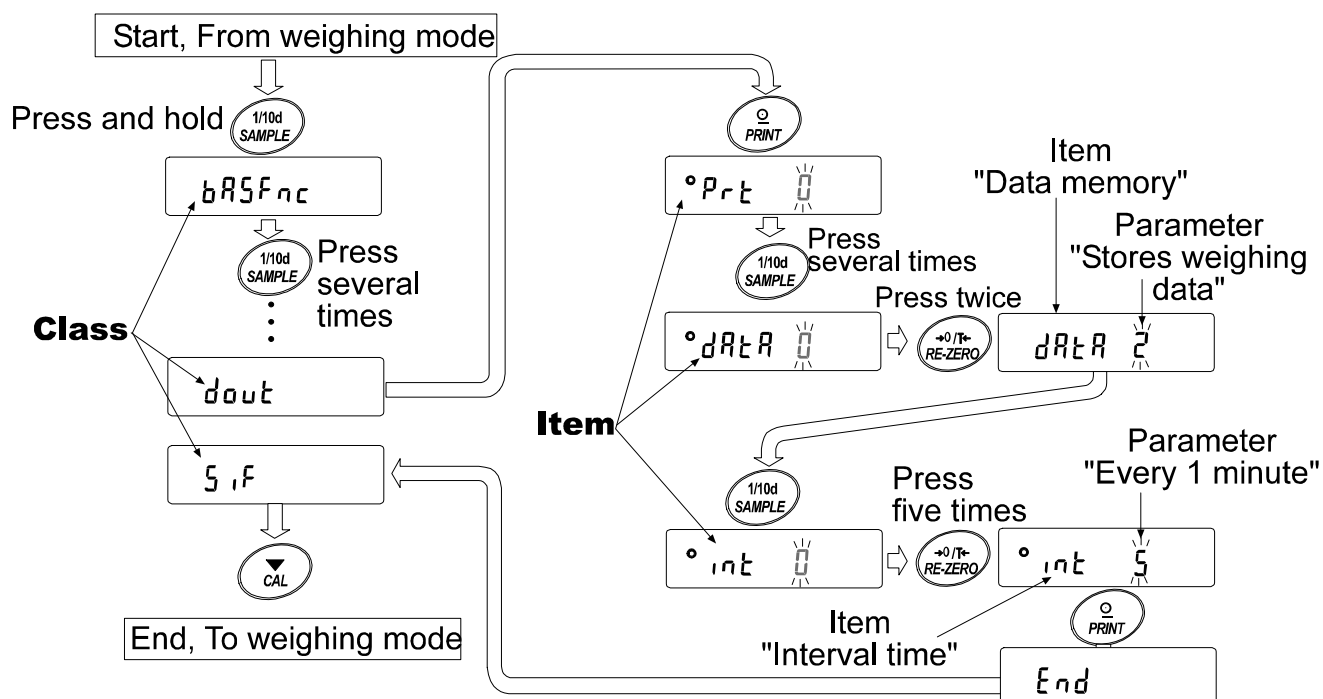

This example sets “Stores weighing data” for “Data memory” and “Every 1 minute” for “Interval time”.



9-2 Display and Keys

Display/Key	Description
◦	The symbol “◦” indicates that the parameter displayed is in effect.
1/10d SAMPLE	When pressed and held in the weighing mode, enters the function table mode. Selects the class or item in the function table mode.
+0/T/- RE-ZERO	Changes the parameter.
○ PRINT	When a class is displayed, moves to an item in the class. When an item is displayed, stores the new parameter and displays the next class.
▼ CAL	When an item is displayed, cancels the new parameter and displays the next class. When a class is displayed, exits the function table mode and returns to the weighing mode.

9-3 Details of the Function Table

Class	Item	Parameter	Description
bRSFnC Environment Display	[ond Condition	0	Fast response, sensitive value <input type="checkbox"/> FAST
		1	 <input type="checkbox"/> MID.
		2	Slow response, stable value <input type="checkbox"/> SLOW
	St-b Stability band width	0	Stable when within ± 1 digit
		1	 Stable when within ± 3 digits
		2	Stable when within ± 3 digits
	Hold Hold function	0	OFF
		1	ON
	trc Zero tracking	0	OFF
		1	Normal
2		Strong	
3		Very strong	
SPd Display refresh rate	0	5 times/second	
	1	10 times/second	
Pnt Decimal point	0	Point (.)	
	1	Comma (,)	
P-on Auto display-ON	0	OFF	
	1	ON	
P-off Auto display-OFF	0	OFF	
	1	ON (10 minutes)	
	0	OFF	
		ON	
[L Add Clock		See "9-9 Clock and Calendar Function"	Confirms and sets the time and date. The time and date are added to output data.
[P Fnc Comparator	[P Comparator mode	0	No comparison
		1	Comparison, excluding "near zero" when stable value or overloaded
		2	Comparison, including "near zero" when stable value or overloaded
		3	Continuous comparison, excluding "near zero"
	4	Continuous comparison, including "near zero"	
	[P in Input method	0	Digital input, upper/lower limits
1		Weighing input, upper/lower limits	
2		Digital input, reference value	
	3	Weighing input, reference value	
[P Hi Upper limit		See "9-10 Comparator Function"	Displayed when [P in 0 or [P in 1 is selected.
[P Lo Lower limit			
[P rEF Reference value		See "9-10 Comparator Function"	Displayed when [P in 2 or [P in 3 is selected.
[P Lt Tolerance			

▪ Factory setting **Note: "Digit" is a unit of minimum weighing value.**

Class	Item	Parameter	Description	
<i>dout</i> Data output	<i>Prt</i> Data output mode	0	Key mode	Accepts the PRINT key only when the display is stable.
		1	Auto print mode A (Reference = zero)	Outputs data when the display is stable and conditions of <i>RP-P</i> , <i>RP-b</i> and the reference value are met.
		2	Auto print mode B (Reference = last stable value)	
		3	Stream mode / Interval memory mode	With <i>dRtR</i> 0, outputs data continuously; with <i>dRtR</i> 2, uses interval memory.
	<i>RP-P</i> Auto print polarity	0	Plus only	Displayed value > Reference
		1	Minus only	Displayed value < Reference
		2	Both	Regardless of displayed value
	<i>RP-b</i> Auto print difference	0	10 digits	Difference between reference value and displayed value
		1	100 digits	
		2	1000 digits	
	<i>dRtR</i> Data memory	0	Not used	Related items: <i>Prt</i> , <i>int</i> , <i>d-no</i> , <i>S-t d</i> , <i>info</i>
		1	Stores unit mass in counting mode	
		2	Stores weighing data	
	<i>int</i> Interval time	0	Every measurement	Interval time in the interval memory mode (with <i>Prt</i> 3, <i>dRtR</i> 2)
		1	Every 2 seconds	
		2	Every 5 seconds	
		3	Every 10 seconds	
		4	Every 30 seconds	
		5	Every 1 minute	
		6	Every 2 minutes	
		7	Every 5 minutes	
<i>d-no</i> Data number output	0	No output	See "11 DATA MEMORY".	
	1	Output		
<i>S-t d</i> Time/Date output	0	No output	Selects whether or not the time or date is added to the weighing data. For details, refer to "9-9 Clock and Calendar Function".	
	1	Time only		
	2	Date only		
<i>S-id</i> ID number output	0	No output	Selects whether or not the ID number is output.	
	1	Output		
<i>PUSE</i> Data output pause	0	No pause	Selects the data output interval.	
	1	Pause (1.6 seconds)		
<i>Rt-F</i> Auto feed	0	Not used	Selects whether or not auto feed is performed.	
	1	Used		
<i>info</i> GLP output	0	No output	Selects GLP output method. For how to set time and date to be added, refer to "9-9 Clock and Calendar Function".	
	1	AD-8121 format		
	2	General data format		
<i>Rr-d</i> Zero after output	0	Not used	Adjusts zero automatically after data is output.	
	1	Used		

■ Factory setting

Class	Item	Parameter	Description		
Serial interface	Baud rate	0	600 bps		
		1	1200 bps		
		2	2400 bps		
		3	4800 bps		
		4	9600 bps		
	Data bit, parity bit	0	7 bits, even		
		1	7 bits, odd		
		2	8 bits, none		
	Terminator	0	CR LF	CR: ASCII code 0Dh	
		1	CR	LF: ASCII code 0Ah	
	Data format	0	A&D standard format		
		1	DP format		See "9-6 Description of Item "Data Format".
		2	KF format		
		3	MT format		
4		NU format			
5		CSV format			
Timeout	0	No limit		Selects the wait time to receive a command.	
	1	1 second			
AK, Error code	0	No output		AK: ASCII code 06h	
	1	Output			
CTS, RTS control	0	Not used		Controls CTS and RTS.	
	1	Used			
Density function	Liquid density input	0	Water temperature	Available only when density mode is selected. See "14. DENSITY MEASUREMENT".	
		1	Liquid density		
Programmable-unit (Multi-unit)		Sets an arbitrary coefficient.		Available only when programmable-unit mode is selected.	
Unit		See "4. WEIGHING UNITS".			
Internal mass value correction		See "7. CALIBRATION".		Displayed only when the internal mass value correction switch is set to 1.	
ID number setting		See "10. ID NUMBER AND GLP REPORT".			

■ Factory setting

Caution

The balance may not transmit the data completely at the specified refresh rate, depending on the baud rate or data added to the weighing data such as time, date and ID number.

9-4 Description of the Class “Environment, Display”

Condition (*Cond*)

Cond 0



Cond 2

This parameter is for sensitive response to the fluctuation of a weight value. Used for powder target weighing, weighing a very light sample or when quick response weighing is required.

After setting, the balance displays **FAST**.

This parameter is for stable weighing with slow response. Used to prevent a weight value from drifting due to vibration or drafts.

After setting, the balance displays **SLOW**.

Notes

In automatic response adjustment, the response rate is selected automatically.

With “Hold function (*Hold*)” set to “ON (1)”, this item is used to set the averaging time.

Stability band width (*St-b*)

This item controls the width to regard a weight value as a stable value. When the fluctuation per second is less than the parameter, the balance displays the stabilization indicator and outputs or stores the data. The parameter influences the “Auto print mode”

St-b 0



St-b 2

This parameter is for sensitive response of the stabilization indicator. Used for exact weighing.

This parameter ignores slight fluctuation of a weight value. Used to prevent a weight value from drifting due to vibration or drafts.

Note

With “Hold function (*Hold*)” set to “ON (1)”, this item is used to set the stabilization range.

Hold function (*Hold*) (Animal weighing mode)

This function is used to weigh a moving object such as an animal.

When the weighing data is over the weighing range from zero and the display fluctuation is within the stabilization range for a fixed period of averaging time, the processing indicator illuminates and the balance displays the average weight of the animal. When the animal is removed from the weighing pan, the display returns to zero automatically.

This function is available only when the hold function parameter is set to “1” (the animal mode indicator **ANIMAL** illuminates) and any weighing unit other than the counting mode is selected.

The stabilization range and averaging time are set in “Condition (*Cond*)” and “Stability band width (*St-b*)”.

Weighing range		Averaging time		Stabilization range	
GX-200/300/400/600/800/1000	0.200 g or over	<i>Cond 0</i>	2 seconds	Faster	<i>St-b 0</i> Small
GX2000/3000/4000/6100	2.00 g or over	<i>Cond 1</i>	4 seconds		<i>St-b 1</i>
GX-6000/8000	10.0 g or over	<i>Cond 2</i>	8 seconds	More accurate	<i>St-b 2</i> Big

Note

The Animal Weighing Bowl Kit (GX-12) is available as an option for all models except GX-200.

Zero tracking (*trc*)

This function tracks zero point drift caused by changes in the environment and stabilizes the zero point. When zero has difficulty stabilizing, select a greater value. When the weighing data is only a few digits, turn the function off for accurate weighing.

<i>trc</i> 0	The tracking function is not used. Used for weighing a very light sample.
<i>trc</i> 1	The tracking function is used. Normal zero tracking.
<i>trc</i> 2	The tracking function is used. Strong zero tracking.
<i>trc</i> 3	The tracking function is used. Very strong zero tracking.

Note

Digit, when used for the GX series balance, indicates a unit of minimum weighing value.

Display refresh rate (*SPd*)

Period to refresh the display. This parameter influences “Baud rate”, “Data output pause” and “Stream mode”.

Note

This item is selected automatically in the automatic response adjustment.

Decimal point (*Pnt*)

The decimal point format can be selected.

Auto display-ON (*P-on*)

When the AC adapter is connected, the display is automatically turned on without the ON:OFF key operation, to display the weighing mode. Used when the balance is built into an automated system. 30-minute warm up is necessary for accurate weighing.

Auto display-OFF (*P-off*)

When the AC adapter is connected and no operation is performed (inactivity state) for 10 minutes, the display is automatically turned off and the standby indicator is illuminated.

Capacity indicator (*CS*)

In the weighing mode, the indicator displays the weighing data relative to the weighing capacity in percentage. (Zero = 0%, maximum capacity = 100%)

When the “Data memory (*dRtR*)” parameter is set to “1” (to store unit mass in the counting mode) or to “2” (to store the weighing data), the indicator displays the information stored in memory, such as the amount of memory data or data number.

9-5 Description of the Item “Data output mode”

The parameter setting of the “Data output mode (*Prt*)” applies to the performance when the “Data memory (*dMEm*)” parameter is set to “2” (to store the weighing data) and when the data is transmitted using the RS-232C interface.

Key mode

When the **PRINT** key is pressed with the stabilization indicator turned on, the balance outputs or stores the weighing data and the display blinks one time.

Required setting	<i>dout</i>	<i>Prt 0</i>	Key mode
------------------	-------------	--------------	----------

Auto print modes A and B

When the displayed value is stable and the conditions of “Auto print polarity”, “Auto print difference” and reference value are met, the balance outputs or stores the weighing data.

When the **PRINT** key is pressed with the stabilization indicator turned on, the balance outputs or stores the data and the display blinks one time.

Mode A: Required setting	<i>dout</i>	<i>Prt 1</i>	Auto print mode A (reference = zero)
	<i>dout</i>	<i>RP-P</i>	Auto print polarity
	<i>dout</i>	<i>RP-b</i>	Auto print difference

Example	“For weighing each time a sample is placed and removed.”
---------	--

Mode B: Required setting	<i>dout</i>	<i>Prt 2</i>	Auto print mode B (reference = last stable value)
	<i>dout</i>	<i>RP-P</i>	Auto print polarity
	<i>dout</i>	<i>RP-b</i>	Auto print difference

Example	“For weighing while a sample is added.”
---------	---

Stream mode

The balance outputs the weighing data continuously regardless of the display condition. The display does not blink in this mode. This mode is not available and the interval memory mode is used when the “Data memory (*dMEm*)” parameter is set to “2” (to store the weighing data).

Required setting	<i>dout</i>	<i>Prt 3</i>	Stream mode
	<i>dout</i>	<i>dMEm 0</i>	Data memory function is not used.
	<i>bRSFnc</i>	<i>SPd</i>	Display refresh rate
	<i>SIF</i>	<i>bPS</i>	Baud rate

Example	“For monitoring data on a computer”
---------	-------------------------------------

Caution

The balance may not transmit the data completely at the specified refresh rate, depending on the baud rate or data added to the weighing data such as time, date and ID number.

Interval memory mode

The weighing data is periodically stored in memory.

Required setting	<i>dout</i>	<i>Prt 3</i>	Interval memory mode
------------------	-------------	--------------	----------------------

	<i>dout</i>	<i>data 2</i>	Data memory function is used. Stores weighing data.
	<i>dout</i>	<i>int</i>	Interval time
Optional setting	<i>dout</i>	<i>5-t d 1, 2, or 3</i>	Adds the time and date.
Example	"For periodical weighing without a computer command and outputting all of the data to a computer at one time"		

9-6 Description of the Item "Data format"

A&D standard format *S IF TYPE 0*

This format is used when the peripheral equipment can receive the A&D format. If an AD-8121B is used, set the printer to MODE 1 or 2.

- This format consists of fifteen characters excluding the terminator.
- A header of two characters indicates the balance condition.
- The polarity sign is placed before the data with the leading zeros. If the data is zero, the plus sign is used.
- The unit, consisting of three characters, follows the data.

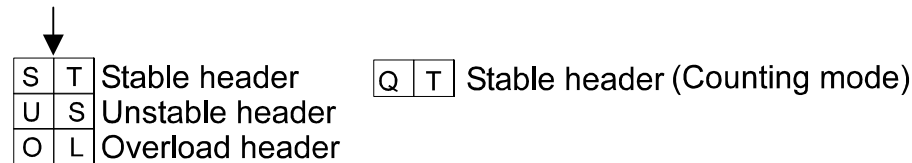
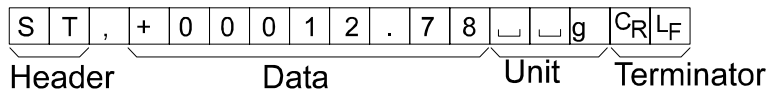

DP (Dump print) format *S IF TYPE 1*

This format is used when the peripheral equipment can not receive the A&D format. If an AD-8121B is used, set the printer to MODE 3.

- This format consists of sixteen characters excluding the terminator.
- A header of two characters indicates the balance condition. No overload header is used.
- The polarity sign is placed before the data, with spaces in place of leading zeros, if the data is not zero or overloaded.
- The unit, consisting of three characters, follows the data.

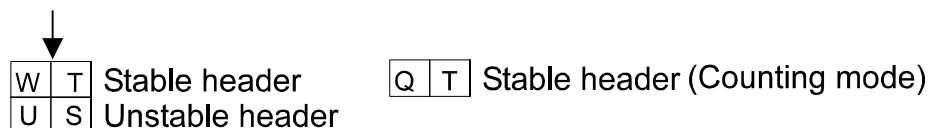
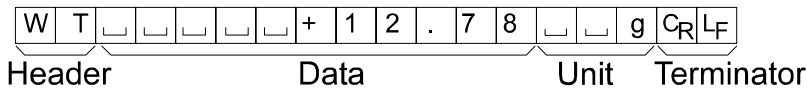

KF format *S IF TYPE 2*

This is the Karl-Fischer moisture meter format and is used when the peripheral equipment can only communicate using this format.

- This format consists of fourteen characters excluding the terminator.
- This format has no header characters.
- The polarity sign is placed before the data, with spaces in place of leading zeros, if the data is

not zero or overloaded.

- This format outputs the unit only for a stable value.

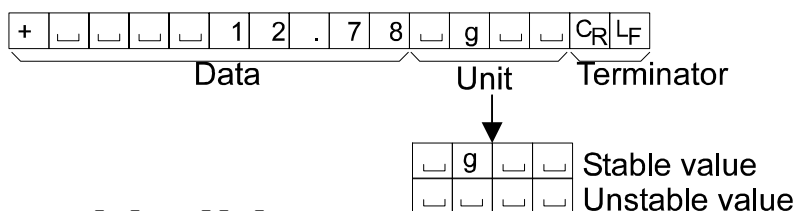

MT format *S, F TYPE 3*

- A header of two characters indicates the balance condition.
- The polarity sign is used only for negative data.
- The weighing data uses spaces in place of the leading zeros.
- The character length of this format changes dependent upon the unit

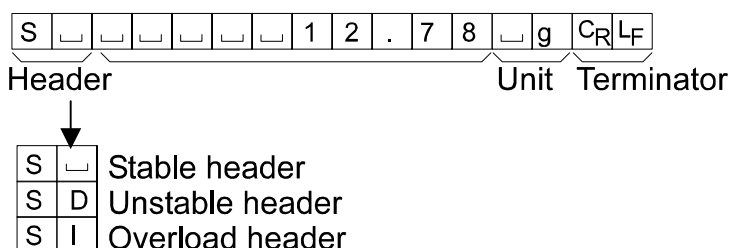

NU (numerical) format *S, F TYPE 4*

This format outputs only numerical data.

- This format consists of nine characters excluding the terminator.
- The polarity sign is placed before the data with the leading zeros. If the data is zero, the plus sign is used.

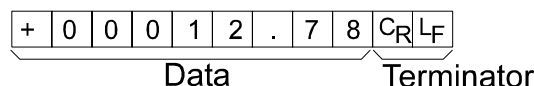

CSV format *S, F TYPE 5*

- Separates the data of A&D standard format and the unit by a comma (,).
- Outputs the unit even when the data is overloaded.
- When the ID number, data number, time and date are added, outputs the ID number, data number, date, time and weighing data in this order and separates each item by a comma and treats all the items as one group of data.

LAB-123, No,012, 2001/12/31, 12:34:56, ST,+00012.78, □ □ g<CR><LF>

ID number
Data number
Date
Time
Weighing data

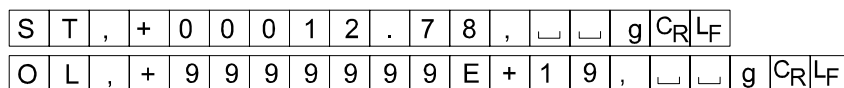

Note

To add the ID number, data number, time and date, the function settings must be changed.

9-7 Description of the Data Format Added to the Weighing Data

Data number *dout d-no 1*

This format outputs the data number just before the data is transmitted using the RS-232C interface.

- This format consists of six characters excluding the terminator.
- When CSV format (*S IF TYPE 5*) is selected, the period (.) is replaced with a comma (,).

N	o	.	0	0	1	C _R	L _F
---	---	---	---	---	---	----------------	----------------

Data number Terminator

Note

The data number is added only to the weighing data that is stored in memory.

Time *dout 5-td 1 or 3*

- Outputs time in 24-hour format.

1	2	:	3	4	:	5	5	C _R	L _F
---	---	---	---	---	---	---	---	----------------	----------------

Date *dout 5-td 2 or 3*

- The date output order can be changed in "Clock (*CL Adj*)". Outputs the year in four-digit format.

2	0	0	1	/	1	2	/	3	1	C _R	L _F
---	---	---	---	---	---	---	---	---	---	----------------	----------------

ID number *dout 5-id 1*

The number to identify a specific balance.

- This format consists of seven characters excluding the terminator.

L	A	B	-	1	2	3	C _R	L _F
---	---	---	---	---	---	---	----------------	----------------

Note

When the data described above is added to the weighing data, the output is in the following order: ID number, Data number, Date, Time and Weighing data.

9-8 Data Format Examples

Stable

°	127	g
---	-----	---

A&D	S	T	,	+	0	0	0	0	1	.	2	7	␣	␣		C _R	L _F	
DP	W	T	␣	␣	␣	␣	␣	␣	+	1	.	2	7	␣	␣	g	C _R	L _F
KF	+	␣	␣	␣	␣	␣	1	.	2	7	␣	g	␣	␣		C _R	L _F	
MT	S	␣	␣	␣	␣	␣	␣	␣	1	.	2	7	␣	g		C _R	L _F	
NU	+	0	0	0	0	1	.	2	7							C _R	L _F	

Unstable

-	18369	g
---	-------	---

A&D	U	S	,	-	0	0	1	8	3	.	6	9	␣	␣	g	C _R	L _F	
DP	U	S	␣	␣	␣	␣	-	1	8	3	.	6	9	␣	␣	g	C _R	L _F
KF	-	␣	␣	␣	1	8	3	.	6	9	␣	␣	␣	␣		C _R	L _F	
MT	S	D	␣	␣	␣	-	1	8	3	.	6	9	␣			C _R	L _F	
NU	-	0	0	1	8	3	.	6	9							C _R	L _F	

Overload

Positive error

E	g
---	---

A&D	O	L	,	+	9	9	9	9	9	9	9	E	+	1	9	C _R	L _F	
DP	␣	␣	␣	␣	␣	␣	␣	␣	␣	␣	␣	␣	␣	␣	␣		C _R	L _F
KF	␣	␣	␣	␣	␣	␣	H	␣	␣	␣	␣	␣	␣	␣		C _R	L _F	
MT	S	I	+													C _R	L _F	
NU	+	9	9	9	9	9	9	9	9							C _R	L _F	

Overload

Negative error

-E	g
----	---

A&D	O	L	,	-	9	9	9	9	9	9	9	E	+	1	9	C _R	L _F	
DP	␣	␣	␣	␣	␣	␣	␣	-	E	␣	␣	␣	␣	␣	␣		C _R	L _F
KF	␣	␣	␣	␣	␣	␣	L	␣	␣	␣	␣	␣	␣	␣		C _R	L _F	
MT	S	I	-													C _R	L _F	
NU	-	9	9	9	9	9	9	9	9							C _R	L _F	

␣ Space, ASCII 20h

C_R Carriage Return, ASCII 0Dh

L_F Line Feed, ASCII 0Ah

Units		A&D	D.P.	KF	MT
g	g	□□g	□□g	□g□□	□g
Counting mode	PC	□PC	□PC	□p c s	□P C S
Precent mode	Pct	□□%	□□%	□%□□	□%
Ounce (Avoir)	oz	□oz	□oz	□oz□	□oz
Pound	Lb	□lb	□lb	□lb□	□lb
Pound Ounce	L oz	□oz	□oz	□oz□	□oz
Troy Ounce	ozt	o z t	o z t	□oz t	□o z t
Metric Carat	ct	□c t	□c t	□c t□	□c t
Momme	mm	m o m	m o m	□m o m	□m o
Pennyweight	dwt	d w t	d w t	□d w t	□d w t
Grain	GN	□G N	□G N	□g r □	□G N
Tael (HK general, Singapore)	TL	□t l	□t l	□t l s	□t l
Tael (HK, jewelry)	TL	□t l	□t l	□t l h	□t l
Tael (Taiwan)	TL	□t l	□t l	□t l t	□t l
Tael (China)	TL	□t l	□t l	□t l c	□t l
Tola (India)	t	□□t	□□t	□t o l	□t
Messghal	MS	m e s	m e s	□M S□	□m
Density	DS	□D S	□D S	□D S□	□D S
Multi	(Blank)	□□□	□□□	□□□□	□

□ Space, ASCII 20h

Note

When “Pound Ounce” is selected, the data is output with the unit of ounce (oz).

9-9 Clock and Calendar Function

The balance is equipped with a clock and calendar function. When the “GLP output (InFd)” parameter is set to “1” or “2” and the “Time/Date output (Std)” parameter is set to “1”, “2” or “3”, the time and date are added to the output data. Set or confirm the time and date as follows:

Operation

- 1 Press and hold the **SAMPLE** key until **bRSFnC** of the function table is displayed.
- 2 Press the **SAMPLE** key several times to display **EL AdJ**.
- 3 Press the **PRINT** key. The balance enters the mode to confirm or set the time and date.

Confirming the time

- 4 The current time is displayed with all the digits blinking.
 - When the time is correct and the date does not need to be confirmed, press the **CAL** key and proceed to step 8.
 - When the time is correct and the date is to be confirmed, press the **SAMPLE** key and proceed to step 6.
 - When the time is not correct and is to be changed, press the **RE-ZERO** key and proceed to step 5.

Setting the time (with part of the digits blinking)

- 5 Set the time in 24-hour format using the following keys.

SAMPLE key	To select the digits to change the value. The selected digits blink.
RE-ZERO key	To increase the value by one.
MODE key	To decrease the value by one.
PRINT key	To store the new setting, display End and go to step 6.
CAL key	To cancel the new setting and go to step 6.

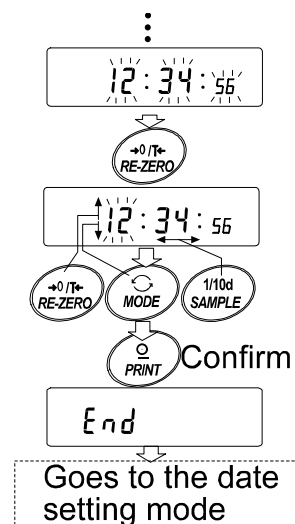

Confirming the date

- 6 The current date is displayed with all the digits blinking.
- To change the display order of year (y), month (m) and day (d), press the **MODE** key. The date is output in the order as specified.
 - When the date is correct and the operation is to be finished, press the **CAL** key and proceed to step 8.
 - When the time is to be confirmed again, press the **SAMPLE** key and go back to step 4.
 - When the date is not correct and is to be changed, press the **RE-ZERO** key and proceed to step 7.

Note

The year is expressed using a two-digit format. For example, the year 2000 is expressed as “00”.

Setting the date (with part of the digits blinking)

- 7 Set the date using the following keys.

SAMPLE key	To select the digits to change the value. The selected digits blink.
RE-ZERO key	To increase the value by one.
MODE key	To decrease the value by one.
PRINT key	To store the new setting, display End and go to step 8.
CAL key	To cancel the new setting and go to step 8.

Quitting the operation

- 8 The balance displays the next menu of the function table. Press the **CAL** key to exit the clock and calendar function and return to the weighing mode.

Notes

Do not enter invalid values such as a non-existing date when setting the time and date.

When the clock backup battery has been depleted, the balance displays **rbc PF**. Under this condition, press any key and set the time and date. The dead battery only affects the clock and calendar function. Even so, the function works normally as long as the AC adapter is connected to the balance.

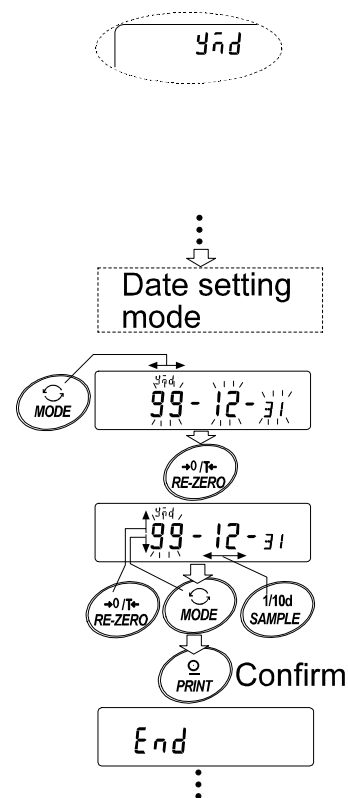

9-10 Comparator Function

The results of the comparison are indicated by **HI** **OK** **LO** on the display.

Operating conditions:

- No comparison

- Comparison when the weighing data is stable or overloaded, excluding “near zero”
- Comparison when the weighing data is stable or overloaded, including “near zero”
- Continuous comparison, excluding “near zero”
- Continuous comparison, including “near zero”

To compare, use:

- Upper limit value and lower limit value
- Reference value and tolerance value

Input method:

- Digital input
- Weighing input

Note

“Near zero” means within ± 10 digits of the minimum weighing value. For example, using a GX-2000 in gram mode, near zero is within ± 0.10 g.

For the description of “Comparator mode ($[CP Fnc]$)”, refer to “9-3 Details of the Function Table”.

Setting example 1

(Continuous comparison, excluding “near zero”, reference value and tolerance value, digital input)

Selecting a comparator mode

- 1 Press and hold the **SAMPLE** key until **bASFnC** of the function table is displayed.
- 2 Press the **SAMPLE** key several times to display **[CP Fnc]**.
- 3 Press the **PRINT** key.
- 4 Press the **RE-ZERO** key several times to display **[CP 3]**.
- 5 Press the **SAMPLE** key several times to display **[CP in]**.
- 6 Press the **RE-ZERO** key several times to display **[CP in 2]**.
- 7 Press the **PRINT** key to store the selected mode.

Entering the reference and tolerance values

- 8 With **[CP rEF]** displayed, press the **PRINT** key. The current setting is displayed with all the digits blinking.
 - When the current setting is not to be changed, press the **PRINT** or **CAL** key to proceed to step 9.
 - When the current setting is to be changed, press the **RE-ZERO** key. Change the setting using the following keys.

SAMPLE key	To select the digit to change the value.
RE-ZERO key	To change the value of the digit selected.
MODE key	To switch the polarity.
PRINT key	To store the new setting and go to step 9.
CAL key	To cancel the new setting and go to step 9.

- 9 With $[CP Ln]$ displayed, press the $[PRINT]$ key. The current setting is displayed. When the current setting is to be changed, change the setting using the following keys. Enter the tolerance value in percentage to the reference value as 100%.

$[SAMPLE]$ key To select the digit to change the value.

$[RE-ZERO]$ key To change the value of the digit selected.

$[PRINT]$ key To store the new setting and go to step 10.

$[CAL]$ key To cancel the new setting and go to step 10.

- 10 Press the $[CAL]$ key to exit the comparator function and return to the weighing mode.

Setting example 2

(Comparison when the weighing data is stable or overloaded, including “near zero”, upper limit and lower limit, weighing input)

Selecting a comparator mode

- 1 Press and hold the $[SAMPLE]$ key until $bASFnC$ of the function table is displayed.
- 2 Press the $[SAMPLE]$ key several times to display $[CP Fnc]$.
- 3 Press the $[PRINT]$ key.
- 4 Press the $[RE-ZERO]$ key several times to display $[CP 2]$.
- 5 Press the $[SAMPLE]$ key several times to display $[CP in]$.
- 6 Press the $[RE-ZERO]$ key several times to display $[CP in 1]$.
- 7 Press the $[PRINT]$ key to store the selected mode.

Entering the upper and lower limit values

- 8 With $[CP Hi]$ displayed, press the $[PRINT]$ key. The current setting is displayed with all of the digits blinking. Press the $[RE-ZERO]$ key to enter the weighing input mode.
- 9 Press the $[RE-ZERO]$ key. The balance displays $0.00g$. Place a sample whose mass corresponds to the upper limit value on the pan. Press the $[PRINT]$ key to store the upper limit value. Remove the sample. The balance displays $[CP Lo]$.
- 10 With $[CP Lo]$ displayed, press the $[PRINT]$ key. The current setting is displayed with all of the digits blinking. Press the $[RE-ZERO]$ key to enter the weighing input mode.
- 11 Press the $[RE-ZERO]$ key. The balance displays $0.00g$. Place a sample whose mass corresponds to the lower limit value on the pan. Press the $[PRINT]$ key to store the lower limit value. Remove the sample.
- 12 Press the $[CAL]$ key to exit the comparator function and return to the weighing mode.

Notes

When Pound/Ounce is selected as a weighing unit, enter the values in ounces for comparison.

In the density mode, comparison is performed to the density obtained.

10. ID NUMBER AND GLP REPORT

- The ID number is used to identify the balance when Good Laboratory Practice (GLP) is used.
- The ID number is maintained in non-volatile memory even if the AC adapter is removed.
- The GLP output format is selected at “GLP output (*inF0*)” of the function table and can be output to a personal computer or printer using the RS-232C serial interface.
- The GLP output format includes the balance manufacturer, model, serial number, ID number, date, time and space for signature for weighing data, and the weight used and results for calibration or calibration test data.
- The balance can output the following reports for GLP.
 - “Calibration report” of the calibration, using the internal mass (Calibration due to changes in temperature and one-touch calibration.)
 - “Calibration report” of the calibration, using an external weight.
 - “Calibration test report” of the calibration test, using an external weight.
 - “Title block” and “End block” for the weighing data.
- Calibration and calibration test data can be stored in memory to output several reports at the same time. Refer to “11. DATA MEMORY” for details.
- For details on confirming and setting the time and date, refer to “9-9 Clock and Calendar Function”.

10-1 Setting the ID Number

- 1 Press and hold the **SAMPLE** key until **bRSFnC** of the function table is displayed.
- 2 Press the **SAMPLE** key several times to display **id**.
- 3 Press the **PRINT** key. Set the ID number using the following keys.
 - RE-ZERO** key To set the character of the digit selected. Refer to the display character set shown below.
 - SAMPLE** key To select the digit to change the value.
 - PRINT** key To store the new ID number and display **bRSFnC**.
 - CAL** key To cancel the new ID number and display **bRSFnC**.
- 4 With **bRSFnC** displayed, press the **CAL** key to return to the weighing mode.

Display character set

0	1	2	3	4	5	6	7	8	9	-	␣	A	B	C	D	E	F	G	H	I	J	K	L	M	N	O	P	Q	R	S	T	U	V	W	X	Y	Z
0	1	2	3	4	5	6	7	8	9	-	␣	R	b	C	d	E	F	G	H	I	J	K	L	M	N	O	P	Q	R	S	T	U	V	W	X	Y	Z

␣ Space

10-2 GLP Report

Set the following parameters to output the report.

- To print the report, set the “GLP output (*info*)” parameter to “1” and use MODE 3 of the AD-8121B. For details on using the printer, refer to “16-1 Connection to the AD-8121B Printer”.
- To output the report to a personal computer using the RS-232C interface, set the “GLP output (*info*)” parameter to “2”.
- If the time and date are not correct, set the correct time and date in “Clock (*CL Adj*)” of the function table.

Note

For operational details about calibration and calibration test, refer to “7. CALIBRATION”.

Calibration report using the internal mass

When the setting is “*info 1*”:

AD-8121 format

```

                A & D
MODEL      GX-2000
S/N       01234567
ID        ABCDEFG
DATE      2001/12/31
TIME      12:34:56
CALIBRATED(INT.)
SIGNATURE
-----
    
```

When the setting is “*info 2*”:

General data format

```

                A_&_D<TERM>
MODEL_____GX-2000<TERM>
S/N_____01234567<TERM>
ID_____ABCDEFG<TERM>
DATE<TERM>
_____2001/12/31<TERM>
TIME<TERM>
_____12:34:56<TERM>
CALIBRATED(INT.)<TERM>
SIGNATURE<TERM>
<TERM>
<TERM>
-----<TERM>
<TERM>
<TERM>
    
```

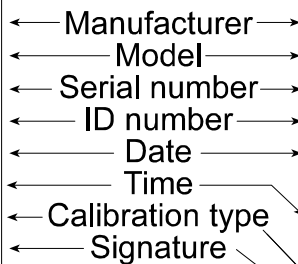

□ Space, ASCII 20h

<TERM> Terminator, C_R, L_F or C_R

C_R Carriage return, ASCII 0Dh

L_F Line feed, ASCII 0Ah

Calibration report using an external weight

When the setting is "info 1":

AD-8121 format

```

      A & D
MODEL    GX-2000
S/N      01234567
ID       ABCDEFG
DATE     2001/12/31
TIME     12:34:56
CALIBRATED(EXT.)
CAL.WEIGHT
      +2000.00  9
SIGNATURE
-----
    
```

← Manufacturer →
 ← Model →
 ← Serial number →
 ← ID number →
 ← Date →
 ← Time →
 ← Calibration type →
 ← Calibration weight →
 ← Signature →

When the setting is "info 2":

General data format

```

.....A_&_D<TERM>
MODEL.....GX-2000<TERM>
S/N.....01234567<TERM>
ID.....ABCDEFG<TERM>
DATE<TERM>
.....2001/12/31<TERM>
TIME<TERM>
.....12:34:56<TERM>
CALIBRATED(EXT.)<TERM>
CAL.WEIGHT<TERM>
.....+2000.00_g<TERM>
SIGNATURE<TERM>
<TERM>
<TERM>
-----<TERM>
<TERM>
<TERM>
    
```

- Space, ASCII 20h
- <TERM> Terminator, CR, LF or CR
- CR Carriage return, ASCII 0Dh
- LF Line feed, ASCII 0Ah

Calibration test report using an external weight

(Calibration test does not perform calibration.)

When the setting is "info 1":

AD-8121 format

```

      A & D
MODEL    GX-2000
S/N      01234567
ID       ABCDEFG
DATE     2001/12/31
TIME     12:34:56
CAL.TEST(EXT.)
ACTUAL
      0.00  9
      +1999.99  9
TARGET
      +2000.00  9
SIGNATURE
-----
    
```

← Manufacturer →
 ← Model →
 ← Serial number →
 ← ID number →
 ← Date →
 ← Time →
 ← Calibration test type →
 ← Zero point value →
 ← Target weight value →
 ← Target weight value →
 ← Signature →

When the setting is "info 2":

General data format

```

.....A_&_D<TERM>
MODEL.....GX-2000<TERM>
S/N.....01234567<TERM>
ID.....ABCDEFG<TERM>
DATE<TERM>
.....2001/12/31<TERM>
TIME<TERM>
.....12:34:56<TERM>
CAL.TEST(EXT.)<TERM>
ACTUAL<TERM>
.....0.00_g<TERM>
.....+1999.99_g<TERM>
TARGET<TERM>
.....+2000.00_g<TERM>
SIGNATURE<TERM>
<TERM>
<TERM>
-----<TERM>
<TERM>
<TERM>
    
```

- Space, ASCII 20h
- <TERM> Terminator, CR, LF or CR
- CR Carriage return, ASCII 0Dh
- LF Line feed, ASCII 0Ah

Title block and end block

When a weight value is recorded as the GLP data, "Title block" and "End block" are inserted at the beginning and at the end of a group of weight values, in the GLP report.

Note

To output the report to an AD-8121B, use MODE 3 of the AD-8121B.

Caution

If the data memory function is used, the "Title block" and "End block" can not be output.

Operation

- 1 With the weighing data displayed, press and hold the **PRINT** key until **Start** is displayed. The "Title block" is output.
- 2 The weighing data is output according to the parameter setting of the data output mode.
- 3 Press and hold the **PRINT** key until **RecEnd**. The "End block" is output.

When the setting is "Info 1":

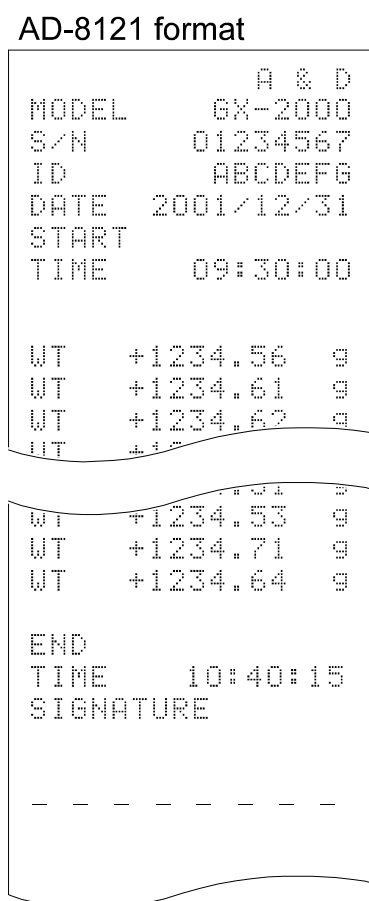

When the setting is "Info 2":

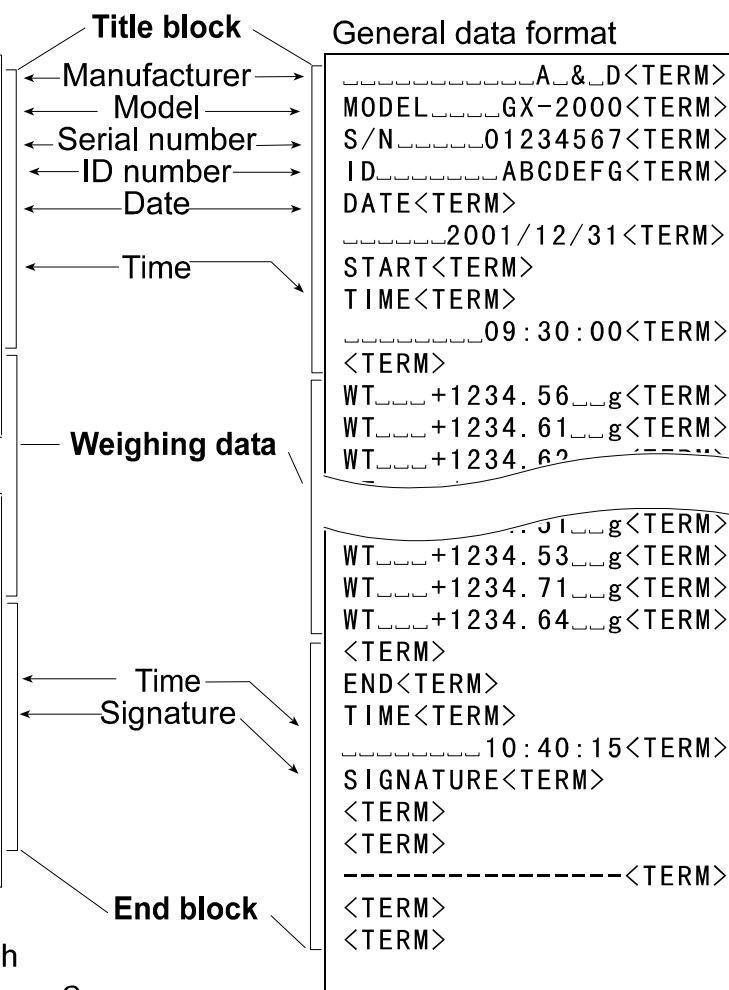

- Space, ASCII 20h
- <TERM> Terminator, C_R, L_F or C_R
- C_R Carriage return, ASCII 0Dh
- L_F Line feed, ASCII 0Ah

11. DATA MEMORY

Data memory is a function to store weighing data, calibration data and unit mass in memory. Of the data in memory, the balance can only display the weighing data. The weighing data and calibration data in memory are available for outputting at one time to a printer or personal computer.

One of the following data set can be stored:

- Weighing data (Up to 200 sets. 100 sets when the time and date are added.)
- Calibration and calibration test data (latest 50 sets)
- Unit mass in the counting mode (Up to 20 sets)

11-1 Notes on Using Data Memory

To use the memory function, set the "Data memory (*dAtA*)" parameter of the function table. In addition, for weighing data, set the "Time/Date output (*S-t d*)" parameter. For details on setting the data memory, refer to "9. FUNCTION TABLE".

For weighing data, the data contents to be stored and the storage capacity depend on the "Time/Date output (*S-t d*)" parameter setting.

Releasing "[Lr]"

If a different type of data exists in memory when the data is stored, "[Lr]" appears blinking in the upper left of the display. For example, you want to store weighing data but calibration data or unit mass data remains in memory.



Under such a condition, before storing data, delete the data in memory as follows:

- 1 Press and hold the **PRINT** key until **[Lr no]** with "no" blinking is displayed.
- 2 Press the **RE-ZERO** key to display **[Lr 00]** with "00" blinking.

The type of data stored in memory appears on the upper left of the display as shown below:

Unit mass in the counting mode	L
Weighing data without time and date	-d-
Weighing data with time and date	d-t
Calibration or calibration test data	H, S

- 3 Press the **PRINT** key to delete all the data in memory.
- 4 The balance displays **[End]** and returns to the weighing mode.

11-2 Memory for Weighing Data

- The data memory function can store 200 sets of weighing data (100 set if time and date are added). Even if the AC adapter is removed, the data is maintained in non-volatile memory.
- It is not necessary that the printer or computer be continually connected to the balance, because the balance stores the weighing data in memory.
- The data in memory is available to be displayed on the balance for confirmation, or to output several sets of data at one time to a printer or personal computer. In the function setting, what data is to be added to the output data (ID number, data number, time and date) can be selected.

Storing the weighing data

Note

If “**Err**” appears blinking in the upper left of the display, delete the data in memory.

- 1 Set the “Data memory (*data*)” parameter to “2”.
- 2 Set the “Time/Date output (*std*)” parameter as necessary.
- 3 The storing operation depends on the “Data output mode (*prt*)” parameter setting. Four types of operating modes are available to store data.

Key mode	When the PRINT key is pressed and the displayed value is stable, the balance stores the weighing data.
Auto print modes A and B	When the displayed value is stable and the conditions of “Auto print polarity”, “Auto print difference” and reference value are met, the balance stores the weighing data.
Interval memory mode	Weighing data is stored at an interval specified in “Interval time (<i>int</i>)”. Press the PRINT key to start and stop this mode.

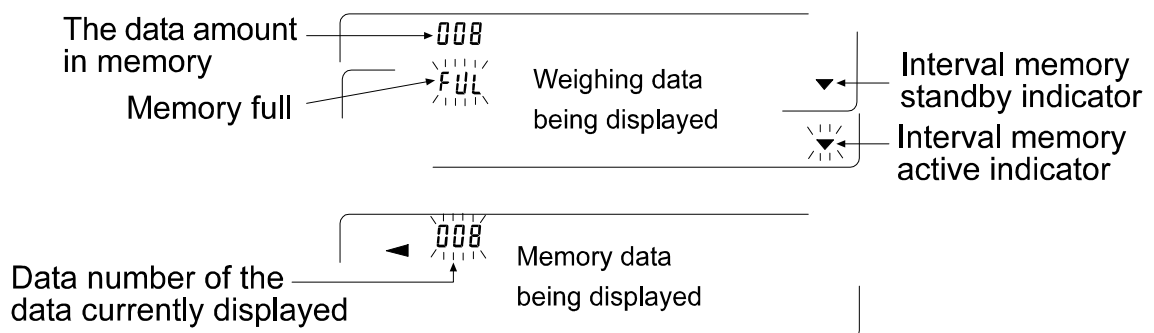

Caution

- When weighing data is being stored in memory, the data can not be output to a personal computer using the RS-232C interface.
- “FUL” indicates that memory is full or the memory capacity has been reached. More data can not be stored unless the memory data is deleted.
- Automatic self calibration can not be used while the interval memory mode is active.
- The following commands can not be used during data storage.

- Q Query command for weighing data.
- S Query command for stable weighing data.
- SI Query command for weighing data.
- SIR Query command for continuous weighing data.

Setting the function table

Parameter settings for each output mode are as follows:

Item	Data output mode	Auto print polarity, difference	Data memory function	Interval time
Key mode	<i>Prt 0</i>	Not used	<i>MEM 2</i>	Not used
Auto print mode A	<i>Prt 1</i>	<i>AP-A 0-2</i>	<i>MEM 2</i>	
Auto print mode B	<i>Prt 2</i>	<i>AP-b 0-2</i>	<i>MEM 2</i>	
Interval memory mode	<i>Prt 3</i>	Not used	<i>MEM 2</i>	

Set each item, depending on the situation, as follows:

Data number	No	<i>d-no 0</i>	Time and date	No	<i>S-td 0</i>
	Yes	<i>d-no 1</i>		Time only	<i>S-td 1</i>
ID number	No	<i>S-id 0</i>		Date only	<i>S-td 2</i>
	Yes	<i>S-id 1</i>		Both	<i>S-td 3</i>

With *S-td 1*, *S-td 2* or *S-td 3* selected, the amount of data to be stored is 100 sets.

Enabling the data memory function

- Press and hold the **SAMPLE** key until **ASFnC** of the function table is displayed.
- Press the **SAMPLE** key several times to display **dout**.
- Press the **PRINT** key.
- Press the **SAMPLE** key three times to display **dAtA 0**.
- Press the **RE-ZERO** key to change **dAtA 0** to **dAtA 2**.
- Press the **PRINT** key to save.
- Press the **CAL** key to return to the weighing mode.

Recalling the memory data

Confirm that the "Data memory (*dAtA*)" parameter is set to "2".

- Press and hold the **PRINT** key until **rECALL** is displayed.
- Press the **PRINT** key to enter the memory recall mode. Recall the data in memory using the following keys

- RE-ZERO** key To proceed to the next data set.
- MODE** key To go back to the previous data set.
- PRINT** key To transmit the current data using the RS-232C interface.

With **SAMPLE** held down, press the **CAL** key
To delete the data currently displayed.

Note: Deleting the data will not increase the number of data that can be stored.

- CAL** key To exit the memory recall mode.

- Press the **CAL** key to return to the weighing mode.

Transmitting all memory data at one time

Confirm that the “Serial interface (S i F)” parameters are set properly. For details, refer to “9. FUNCTION TABLE” and “16. CONNECTION TO PERIPHERAL EQUIPMENT”.

- 1 Press and hold the **PRINT** key until **rEeALL** is displayed.
- 2 Press the **SAMPLE** key to display **out**.
- 3 Press the **PRINT** key to display **out no** with “no” blinking.
- 5 Press the **RE-ZERO** key to display **out Go** with “Go” blinking.
- 6 Press the **PRINT** key to transmit all data using the RS-232C interface.
- 7 The balance displays **CLERr** when all data is transmitted. Press the **CAL** key to return to the weighing mode.

Deleting all memory data at one time

- 1 Press and hold the **PRINT** key until **rEeALL** is displayed.
- 2 Press the **SAMPLE** key several times to display **CLERr**.
- 3 Press the **PRINT** key to display **CLr no** with “no” blinking.
- 4 Press the **RE-ZERO** key to display **CLr Go** with “Go” blinking.
- 5 Press the **PRINT** key to delete all data
- 6 The balance displays **End**, then **rEeALL** when all data is deleted.
- 7 Press the **CAL** key to return to the weighing mode.

11-3 Memory for Calibration and Calibration Test Data

- Calibration data (when and how it is performed) and calibration test data can be stored in memory.
- All the data in memory is available to be output at one time to a printer or personal computer.
- Up to 50 data sets of the latest calibration or calibration test can be stored. When the memory capacity has been reached, "FUL" illuminates.

Storing the calibration and calibration test data

Note

If "ELr" appears blinking in the upper left of the display, delete the data in memory.

Store the calibration and calibration test data as follows:

- 1 Set the "Data memory (dAtA)" parameter to "3".
- 2 Set the "GLP output (inF0)" parameter to "1" or "2".
- 3 With the settings above, each time calibration or calibration test is performed, the data is stored automatically.

Transmitting the memory data

Confirm that the "Serial interface (SIF)" parameters are set properly. For details, refer to "9. FUNCTION TABLE" and "16. CONNECTION TO PERIPHERAL EQUIPMENT" and also confirm that the "Data memory (dAtA)" parameter is set to "3".

- 1 Press and hold the **PRINT** key until **out** is displayed.
- 2 Press the **PRINT** key to display **out no** with "no" blinking.
- 3 Press the **RE-ZERO** key to display **out 00** with "00" blinking.
- 4 Press the **PRINT** key to transmit all memory data using the RS-232C interface.
- 5 The balance displays **CLEAR** when all memory data is output. Press the **CAL** key to return to the weighing mode.

Deleting the memory data

- 1 Press and hold the **PRINT** key until **out** is displayed.
- 2 Press the **SAMPLE** key to display **CLEAR**.
- 3 Press the **PRINT** key to display **ELr no** with "no" blinking.
- 4 Press the **RE-ZERO** key to display **ELr 00** with "00" blinking.
- 5 Press the **PRINT** key to delete all data
- 6 The balance displays **out** when all the data has been deleted. Press the **CAL** key to return to the weighing mode.

11-4 Memory for Unit Mass in the Counting Mode

- The data memory function can store 20 sets of unit mass for the counting mode. Even if the AC adapter is removed, the data is maintained in non-volatile memory. Among the 20 sets, “P01” is the memory function for the standard counting mode.
- The unit mass in memory can be recalled and used for weighing.
- The unit mass in memory can be recalled and changed.

Recalling the unit mass

- 1 Set the “Data memory (*dAER*)” parameter to “1”.
- 2 Press the **MODE** key to select **PC** (counting mode).

Notes

If the counting mode can not be selected, refer to “4. WEIGHING UNITS”.

If “*LCr*” appears blinking in the upper left of the display, delete the data in memory.

- 3 Press and hold the **PRINT** key until the balance enters the sample unit mass selection mode as shown below.

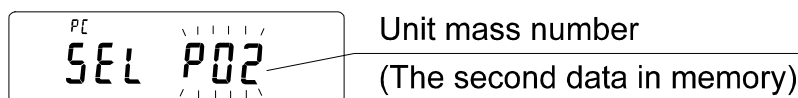

- 4 Select the unit mass to be used using the following keys.

RE-ZERO key	To increase the unit mass number by one.
MODE key	To decrease the unit mass by one.
PRINT key	To select the unit mass number to be used.
CAL key	To cancel the operation and go to step 5.

- 5 To re-store the unit mass or perform Automatic Counting Accuracy Improvement (ACAI) on the stored unit mass, follow the procedure described in “5-2 Counting Mode (PC)”.

Note

ACAI can not be performed on the recalled unit mass.

12. UNDERHOOK

The underhook can be used for weighing large samples, magnetic materials or for measuring density. The built-in underhook is revealed by removing the plastic cap on the bottom of the balance. Use the underhook as shown below.

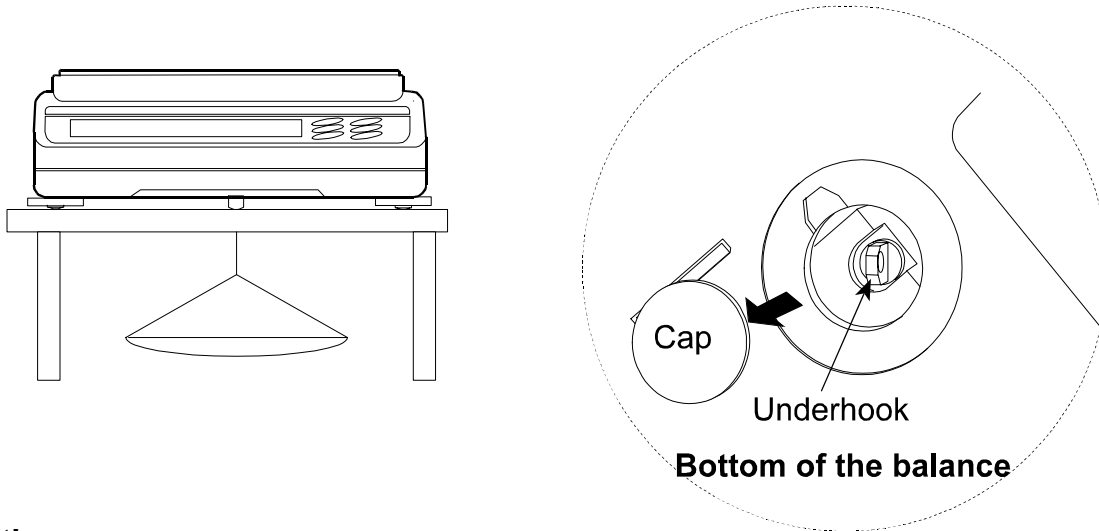

Caution

Do not apply excessive force to the underhook.

When not in use, attach the plastic cap to prevent dust from getting into the balance.

13. PROGRAMMABLE-UNIT

This is a programmable unit conversion function. It multiplies the weighing data in grams by an arbitrary coefficient set in the function table and displays the result.

The coefficient must be within the range between the minimum and maximum shown below. If the coefficient set is beyond the range, an error is displayed and the balance returns to the coefficient setting mode, prompting to enter an appropriate value. A coefficient of 1 was set at the factory.

Model	Minimum coefficient	Maximum coefficient
GX-200/300/400/600/800/1000	0.000001	1000
GX-2000/3000/4000/6100		100
GX-6000/8000		10

Operation

- 1 Press and hold the **SAMPLE** key until **bASFnC** of the function table is displayed.
- 2 Press the **SAMPLE** key several times to display **nLt**.
- 3 Press the **PRINT** key. The balance enters the mode to confirm or set the coefficient.

Confirming the coefficient

- 4 The current coefficient is displayed with the first digit blinking.
 - When it is not to be changed, press the **CAL** key and proceed to step 8.
 - When it is to be changed, press the **RE-ZERO** key and proceed to step 6.

Setting the coefficient

- 5 Set the coefficient using the following keys.

SAMPLE key To select a digit to change the value. The selected digit blinks.

RE-ZERO key To change the value.

MODE key To change the decimal point position.

Each time the switch is pressed, the decimal point position changes as follows:

→ 0.000001 → 00.00001 → ... → 000000.1 → 0000001

PRINT key To store the new setting, display **End** and go to step 6.

CAL key To cancel the new setting and go to step 6.

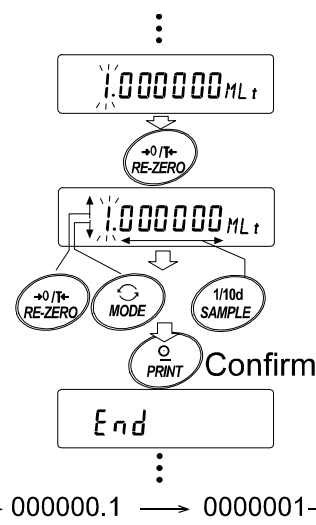

Quitting the operation

- 6 The balance displays **Unit**. Press the **CAL** key to exit the programmable-unit function and return to the weighing mode.

Using the function

Press the **MODE** key to select the programmable-unit (no display on the unit section). Perform weighing as described in "5-1 Basic Operation (Gram Mode)". After weighing, the balance displays the result (weighing data in grams x coefficient).

14. DENSITY MEASUREMENT

The GX series balance is equipped with a density mode. It calculates the density of a solid using the weight of a sample in air and the weight in liquid.

- The density mode was not selected for use when the balance was shipped from the factory. To use the mode, change the function table and activate the density mode.
- Two ways to set the density of a liquid are available:
by entering the water temperature or by entering the density directly.
- The density determination kit (GX-13) is available as an option for GX-200/300/400/600/800/1000.

Formula to obtain the density

The density can be obtained by the following formula.

$$\rho = \frac{A}{A - B} \times \rho_0$$

Where ρ : Density of a sample
 A: Weight value of a sample in air
 B: Weight value of a sample in liquid
 ρ_0 : Density of a liquid

Changing the function table

(1) Selecting the density mode

The density mode is available as one of the weighing units. To use the mode, select it in the function table. For details, refer to “4-2 Storing a Unit”.

(2) Selecting a way to set the density of a liquid

Select the liquid density input method from the function table below. The function table is available only when the density mode is selected.

Class	Item	Parameter	Description
d5 Fnc	Ld in	□	Water temperature
Density function	Liquid density input	!	Liquid density

□ = Factory setting

Setting the density of a liquid

1. Press the **MODE** key as necessary to select the density mode. When the processing indicator blinks with the unit “g” displayed, it indicates that the density mode is selected.
2. In the density mode, press and hold the **MODE** key to enter the mode to set the liquid density.

Note

In the normal weighing mode, the same procedure will activate the automatic response adjustment. This function is not available in the density mode.

Entering the water temperature (Ld in □)

In the density mode, press and hold the **MODE** key until the water temperature currently set (unit:°C, factory setting : 25°C) is displayed. Use the following keys to change the value.

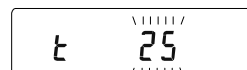

RE-ZERO key To increase the temperature by one degree. (0-99)

MODE key To decrease the temperature by one degree. (0-99)

PRINT key To store the change, display **End** and return to the density mode.

CAL key To cancel the change and return to the density mode.

The relation between the water temperature and density is shown below.

Temp. (°C)	+0	+1	+2	+3	+4	+5	+6	+7	+8	+9
0	0.99984	0.99990	0.99994	0.99996	0.99997	0.99996	0.99994	0.99990	0.99985	0.99978
10	0.99970	0.99961	0.99949	0.99938	0.99924	0.99910	0.99894	0.99877	0.99860	0.99841
20	0.99820	0.99799	0.99777	0.99754	0.99730	0.99704	0.99678	0.99651	0.99623	0.99594
30	0.99565	0.99534	0.99503	0.99470	0.99437	0.99403	0.99368	0.99333	0.99297	0.99259
40	0.99222	0.99183	0.99144	0.99104	0.99063	0.99021	0.98979	0.98936	0.98893	0.98849
50	0.98804	0.98758	0.98712	0.98665	0.98618	0.98570	0.98521	0.98471	0.98422	0.98371
60	0.98320	0.98268	0.98216	0.98163	0.98110	0.98055	0.98001	0.97946	0.97890	0.97834
70	0.97777	0.97720	0.97662	0.97603	0.97544	0.97485	0.97425	0.97364	0.97303	0.97242
80	0.97180	0.97117	0.97054	0.96991	0.96927	0.96862	0.96797	0.96731	0.96665	0.96600
90	0.96532	0.96465	0.96397	0.96328	0.96259	0.96190	0.96120	0.96050	0.95979	0.95906

Entering the density directly (*L d in l*)

In the density mode, press and hold the **MODE** key until the density currently set (unit : g / cm³, factory setting : 1.000g / cm³) is displayed. Use the following keys to change the value.



RE-ZERO key To set the value of the digit selected.

SAMPLE key To select the digit to change the value.

PRINT key To store the change, display **End** and return to the density mode.

CAL key To cancel the change and return to the density mode.

Note

The range to set the density is 0.0000 to 1.9999 g / cm³

Measuring the density

In the density measurement, the balance displays the weight of a sample in air, the weight in liquid and then the density.

- Measuring the weight of a sample in air.

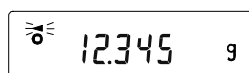

The processing indicator blinks with the unit "g" displayed.

- Measuring the weight of a sample in liquid.

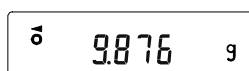

The processing indicator illuminates with the unit "g" displayed.

- Displaying the density.

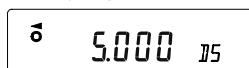

The processing indicator illuminates with "DS" displayed.

To cycle through the above three, press the **SAMPLE** key.

Note

The **SAMPLE** key can not be used to change the minimum weighing value. The density is displayed with three decimal places.

Measuring procedure

- 1 Confirm that the balance is in the mode to measure the weight of the sample in air. ("g" displayed and processing indicator blinking)
- 2 Confirm that the balance indicates zero. If it does not indicate zero, press the **RE-ZERO** to reset the displayed value to zero.
- 3 Place the sample on the upper pan (in air). When the value displayed on the balance becomes stable, press the **SAMPLE** key to confirm the value (the weight of the sample in air). The balance enters the mode to measure the weight of the sample in liquid ("g" displayed and processing indicator illuminating).

Note

If a negative value or E (error) is displayed, the **SAMPLE** key is disabled.

- 4 Remove the sample from the upper pan and place it on the lower pan (in liquid). When the value displayed on the balance becomes stable, press the **SAMPLE** key to confirm the value (the weight of the sample in liquid). The balance enters the mode to display the density ("g" disappears).

Note

If E (error) is displayed, the **SAMPLE** key is disabled.

- 5 To output or store the density, press the **PRINT** key. The density output unit is "DS". To measure the density of another sample, press the **SAMPLE** key to return to the mode to measure the weight in air and repeat the procedure described above.

Note

If the liquid temperature or the type of liquid is changed during measurement, reset the value of the liquid density as necessary. For details, refer to "Setting the density of a liquid".

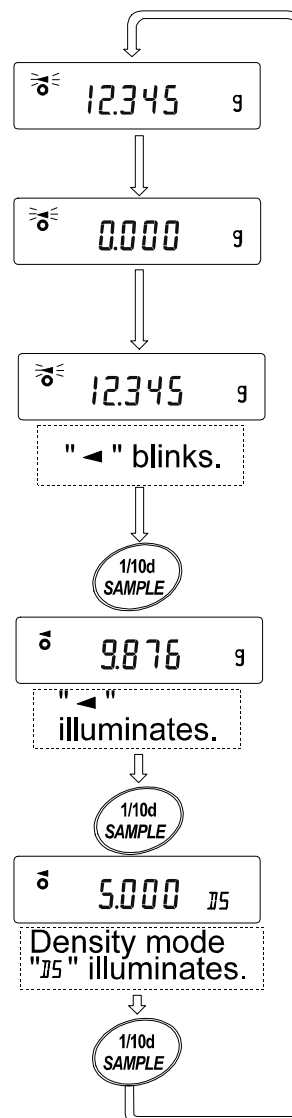

15. RS-232C SERIAL INTERFACE / EXTERNAL INPUT

RS-232C

The balance is a DCE device. Connect the balance to a personal computer (DTE), using a straight through cable or a modem cable.

Transmission system : EIA RS-232C
 Transmission form : Asynchronous, bi-directional, half duplex
 Data format : Baud rate : 600, 1200, 2400, 4800, 9600 bps
 Data bits : 7 or 8 bits
 Parity : Even, Odd (Data bits 7 bits)
 None (Data bits 8 bits)
 Stop bit : 1 bit
 Code : ASCII

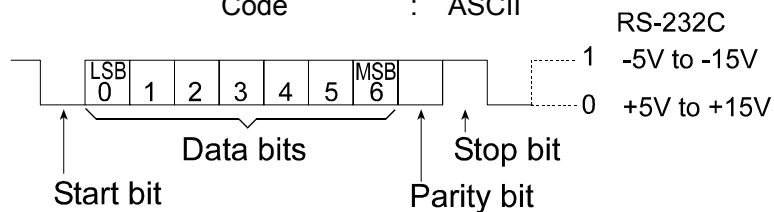

Pin connections

Pin No.	Signal name	Direction	Description
1	FG	-	Frame ground
2	RXD	Input	Receive data
3	TXD	Output	Transmit data
4	RTS	Input	Ready to send
5	CTS	Output	Clear to send
6	DSR	Output	Data set ready
7	SG	-	Signal ground
18	PRINT	Input	Same as the PRINT key
19	RE-ZERO	Input	Same as the RE-ZERO key
8 – 25 (Excluding 18 and 19)	-	-	Not connected

Note

The signal names for the RS-232C are the same as those for the DTE side except TXD and RXD.

Circuits

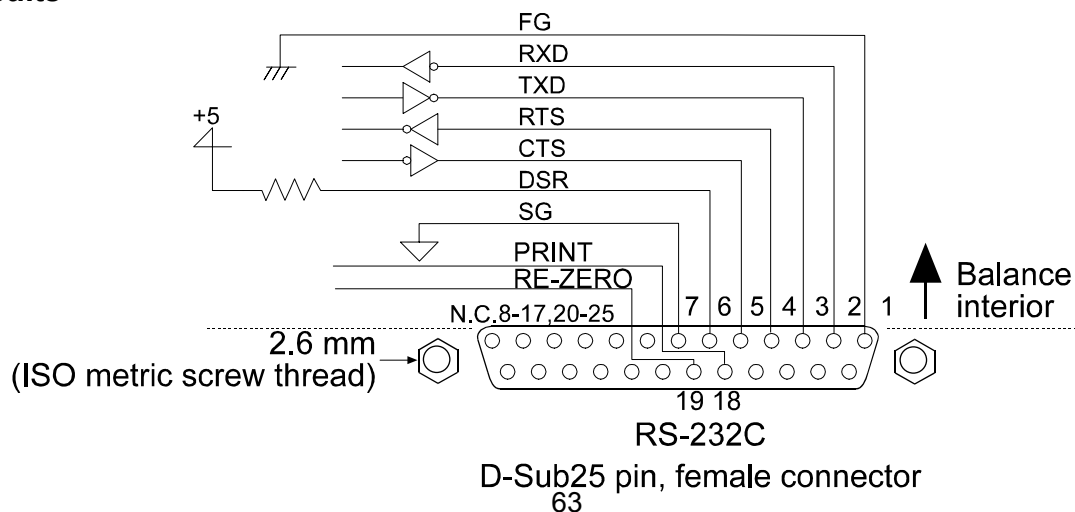

External input

Pin 18 and pin 19 perform the same function as pressing the **PRINT** and **RE-ZERO** keys respectively by connecting each pin to pin 7 for at least 100 m seconds.

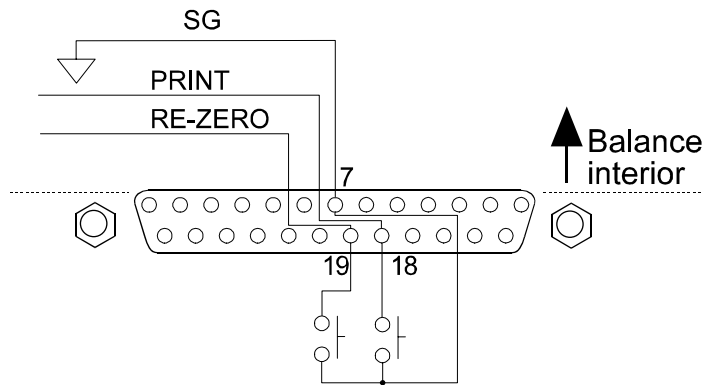

Use of example

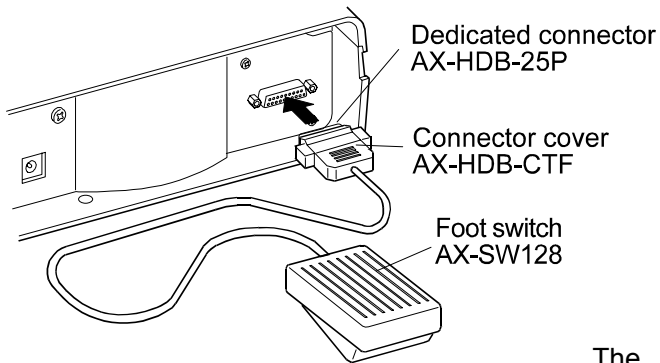

The external input connector (AX-HDB-25P/CTF) and the foot switch (AX-SW128) are sold separately.

16. CONNECTION TO PERIPHERAL EQUIPMENT

16-1 Connection to the AD-8121B Printer

Set the following parameters to use the AD-8121B printer.

Function setting	Description
<i>dout Prt 0-3</i>	Selects a print mode.
<i>dout RP-P 0-2</i>	Selects the polarity for the auto print mode.
<i>dout RP-b 0-2</i>	Selects the auto print difference.
<i>dout PUSE 0,1</i>	Selects data output pause.
<i>S iF bPS 2</i> Factory setting	2400 bps
<i>S iF bPr 0</i> Factory setting	7 bits, Even parity check
<i>S iF CrLF 0</i> Factory setting	CR, LF
<i>S iF Cts 0</i> Factory setting	CTS and RTS control, not used

When "MODE 1" or "MODE 2" of the AD-8121B printer is used	
<i>dout S-td 0</i> Factory setting	Not to output the time and date.
<i>dout S-id 0</i> Factory setting	Not to output the ID number.
<i>dout Rt-F 0</i> Factory setting	Not to use auto feed.
<i>S iF tYPE 0</i> Factory setting	A&D standard format

When "MODE 3" of the AD-8121B printer is used.	
<i>dout S-td 0-3</i>	Outputs the time and date as necessary.
<i>dout S-id 0,1</i>	Outputs the ID number as necessary.
<i>dout Rt-F 0,1</i>	Uses auto feed as necessary.
<i>S iF tYPE 1</i>	DP format

When data is transmitted continuously. When all memory data is transmitted at one time.	
<i>dout PUSE 1</i>	Uses pause.

Note

The printer performs as follows, depending on the data memory setting.

Setting	What is printed
<i>dRtR 0</i>	The weighing data
<i>dRtR 2</i>	The weighing data stored in memory
<i>dRtR 3</i>	The calibration or calibration test data stored in memory

Refer to "10. ID NUMBER AND GLP REPORT" for a print sample.

16-2 Connection to a Computer

The GX series balance is of the DCE type (Data Communication Equipment), which can be connected to a personal computer using the RS-232C interface.

Before connection, read the personal computer manual thoroughly.

Use a standard DCE cable for connection (cable type: straight-through).

16-3 Using Windows Communication Tools (WinCT)

When Windows is used as an operating system in a personal computer, the provided WinCT can be

used to transmit the weighing data to the personal computer.

The WinCT has two communication methods: “RsCom” and “RsKey”. For details on WinCT, refer to the WinCT instruction manual.

RsCom

- Can transmit commands to control the balance.
- Can make a bi-directional communication between the balance and a personal computer using the RS-232C interface.
- Can display or store the data using a text file format. Can also print the data using a printer connected to the personal computer.
- When several ports of a personal computer have balances connected, can communicate with each balance simultaneously.
- Can share a personal computer with other application software.
- Can receive the balance GLP report.

RsKey

- Can transmit the weighing data output from the balance directly to other application software such as Microsoft Excel.
- Can be used with most application software.
- Can receive the balance GLP report.

Note

Windows and Excel are the registered trademarks of the Microsoft Corporation.

Using the WinCT, the balance can do the following:

- 1 Analyzing the weighing data and the statistics with “RsKey”
The weighing data can be input directly into an Excel worksheet. Then, Excel can analyze the data to obtain total, average, standard deviation, maximum and minimum value, and display them in a graph.
- 2 Controlling the balance using commands from a personal computer
By using “RsCom”, the personal computer sends commands such as “re-zero” or “send weighing data” to the balance and controls the balance.
- 3 Printing the balance GLP report using your printer
The balance GLP report can be printed using a printer connected to the personal computer.
- 4 Receiving weighing data at a certain interval
The weighing data can be received at a certain interval and data characteristic with elapsed time can be obtained.
- 5 Using the GX series balance memory function
The weighing data, instead of outputting it immediately to an external device, can be stored in the balance’s memory. Later, all of the weighing data stored can be output to a personal computer at one time.
- 6 Using a personal computer as an external indicator
With the “RsKey” test mode function, a personal computer can be used as an external weight indicator for the balance. (To do this, set the balance data output mode to stream mode.)

17. COMMANDS

17-1 Command List

Commands to query weighing data

C	Cancels the S or SIR command.
Q	Requests the weighing data immediately.
S	Requests the weighing data when stabilized.
SI	Requests the weighing data immediately.
SIR	Requests the weighing data continuously.
^E_{sc}P	Requests the weighing data when stabilized.

Note: The “Q” and “SI” commands, the “S” and “^E_{sc}P” commands behave the same.

Commands to control the balance

CAL	Same as the CAL key.
MCL	Deletes all data in memory.
MD:nnn	Deletes weighing data with the data number nnn.
OFF	Turns the display off.
ON	Turns the display on.
P	Same as the ON:OFF key
PRT	Same as the PRINT key
R	Same as the RE-ZERO key
SMP	Same as the SAMPLE key.
U	Same as the MODE key
T	Same as the RE-ZERO key
Z	Same as the RE-ZERO key
^E_{sc}T	Same as the RE-ZERO key

Note: The “R”, “T”, “Z” and “^E_{sc}T” commands behave the same.

Commands to control the memory function

?MA	Outputs all data in memory.
?MQnnn	Outputs weighing data with the data number nnn.
?MX	Outputs the number of weighing data in memory.
MCL	Deletes all data in memory.
MD:nnn	Deletes weighing data with the data number nnn.
UN:mm	Changes the unit mass stored in memory with the number of mm (01-20).
?UN	Outputs the unit mass number of the selected unit mass.
UW:***. ** g	Sets the unit mass value. e.g.,UW:+0.123 g (to set the unit mass to 0.123 g; represents a space.)
?UW	Outputs the unit mass value of the selected unit mass number.
?ID	Requests the ID number.
?SN	Requests the serial number.
?TN	Requests the model name.

Commands to control the comparator function

HI:***. ** g	Sets the upper limit value. e.g.,HI:+2.34 g (to set the upper limit value to 2.34 g; represents a space.)
LO:***. ** g	Sets the lower limit value. e.g.,LO:+1.23 g (to set the lower limit value to 1.23 g; represents a space.)
?HI	Outputs the upper limit value.
?LO	Outputs the lower limit value.

Notes

“nnn” and “mm” indicate, respectively, three-digit and two-digit numerical values.

^E_{sc}: 1Bh in ASCII code

Before transmitting a command, add the terminator (<CR><LF> or <CR>), that is specified in the “Terminator (LF)” parameter of “Serial interface (SIF)” in the function table, to the command.

To use a command to control the comparator function, set the “Input method (IP in)” parameter to “U” or “P”.

17-2 Acknowledge Code and Error Codes

When the "Serial interface function (S I F)" parameter is set to "E r [d l]", the balance outputs <AK> code or error code to each command as follows:

<AK> (06h) Acknowledge in ASCII code.

- When the balance receives a command to request data and can not process it, the balance transmits an error code (EC, Exx).

When the balance receives a command to request data and can process it, the balance outputs the data.

- When the balance receives a command to control the balance and can not process it, the balance transmits an error code (EC, Exx).

When the balance receives a command to control the balance and can process it, the balance transmits the acknowledge code.

Among commands to control the balance, the following transmit the acknowledge code both when the balance receives the command and when the balance has accomplished the command. If the command can not be processed properly, the balance transmits an error code (EC, Exx). This error can be released using the CAL command.

CAL command (Calibration command) ON command (Display ON command)

P command (Display ON/OFF command) R command (RE-ZERO command)

R command example

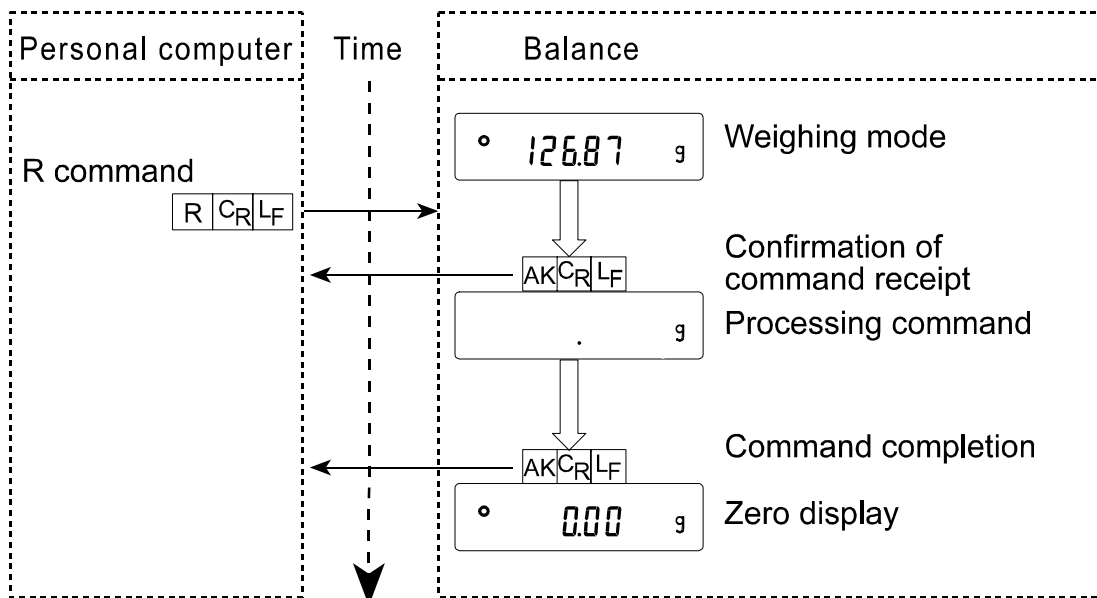

- When a communication error has occurred due to external noise, or a parity error has occurred due to transmission error, the balance transmits an error code. In this case, send the command again.

17-3 Control Using CTS and RTS

Depending on the "[CTS]" parameter of "Serial interface (S_{IF})", the balance performs as follows:

[CTS 0]

Regardless of whether the balance can receive a command or not, the balance keeps the CTS line Hi. The balance outputs data regardless of condition of the RTS line.

[CTS 1]

The CTS line is kept Hi normally. When the balance can not receive the next command (e.g. while the balance is processing last command), the balance sets the CTS line to Lo. The balance confirms the level of the RTS line before outputting a set of data. If the RTS level is Hi, the balance outputs data. If the RTS level is Lo, data is not output (The data is canceled).

17-4 Settings Related to RS-232C

Concerning the RS-232C, the balance has two functions: "Data output (d_{out})" and "Serial interface (S_{IF})". Set each function as necessary.

18. MAINTENANCE

- Do not disassemble the balance. Contact the local A&D dealer if the balance needs service or repair.
- Use the original packing material for transportation.
- Do not use organic solvents to clean the balance. Clean the balance with a lint free cloth that is moistened with warm water and a mild detergent.
- The mass of the internal mass may change due to corrosion or other damage caused by the operating environment, or due to aging. Check the internal mass using an external weight periodically.

19. TROUBLESHOOTING

19-1 Checking the Balance Performance and Environment

The balance is a precision instrument. When the operating environment or the operating method is inadequate, correct weighing can not be performed. Place a sample on the pan and remove it, and repeat this several times. If the balance seems to have a problem with repeatability or to perform improperly, check as described below. If improper performance persists after checking, contact the local A&D dealer for repair.

Checking that the balance performs properly

- Check the balance performance using the self-check function as described in “6-1 Automatic Response Adjustment / Self Check Function”.
An error display appears when a malfunction is found.
- Check the balance repeatability using an external weight. Be sure to place the weight in the center of the weighing pan.
- Check the balance repeatability, linearity and calibrated value using external weights with a known value.

Checking that the operating environment or weighing method is proper

Operating environment

- Is the weighing table solid enough (especially for GX-200/300/400/600/800/1000, the balance with a minimum weighing value of 0.001 g)?
- Is the balance level? Refer to “3-1 Before Use”.
- Is the operating environment free from vibration and drafts? For the GX-200/300/400/600/800/1000, has the breeze break been installed?
- Is there a strong electrical or magnetic noise source such as a motor near the balance?



Weighing method







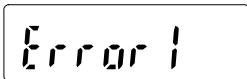

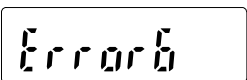
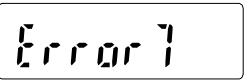
- Does the weighing pan touch the breeze ring or anything? Is the weighing pan installed correctly?
- Is the **RE-ZERO** key pressed before placing a sample on the weighing pan?
- Is the sample placed in the center of the weighing pan?
- Has the balance been calibrated using the internal mass (one-touch calibration)?
- Has the balance been warmed up for 30 minutes before weighing?

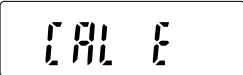
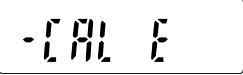
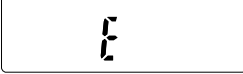
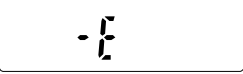
Sample and container

- Has the sample absorbed or lost moisture due to the ambient conditions such as temperature and humidity?
- Has the temperature of the container been allowed to equalize to the ambient temperature? Refer to “3-2 During Use”.
- Is the sample charged with static electricity? Refer to “3-2 During Use”.
The GX-200/300/400/600/800/1000 is prone to be charged with static electricity when the relative humidity is low.
- Is the sample of magnetic material such as iron? Caution is required for weighing magnetic materials. Refer to “3-2 During Use”.

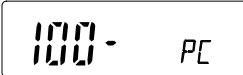
19-2 Error Codes

Display	Error code	Description
	EC, E11	<p>Stability error</p> <p>The balance can not stabilize due to an environmental problem. Prevent vibration, drafts, temperature changes, static electricity and magnetic fields.</p> <p>Refer to “3. PRECAUTIONS” for details on the operating environment and “6. RESPONSE ADJUSTMENT” about adapting the balance to the environment.</p> <p>To return to the weighing mode, press the CAL key.</p>
		<p>Out of range error</p> <p>The value entered is beyond the settable range.</p> <p>Re-enter the value.</p>
	EC, E16	<p>Internal mass error</p> <p>Applying the internal mass does not yield a change in the weighing value as specified.</p> <p>Confirm that there is nothing on the pan and perform the weighing operation from the beginning again.</p>
	EC, E17	<p>Internal mass error</p> <p>The internal mass application mechanism does not function properly.</p> <p>Perform the weighing operation from the beginning again.</p>

Display	Error code	Description
	EC, E20	<p>Calibration weight error</p> <p>The calibration weight is too heavy. Confirm the calibration weight value.</p> <p>Press the CAL key to return to the weighing mode.</p>
	EC, E21	<p>Calibration weight error</p> <p>The calibration weight is too light. Confirm the calibration weight value.</p> <p>Press the CAL key to return to the weighing mode.</p>
		<p>Overload error</p> <p>A sample beyond the balance weighing capacity has been placed on the pan.</p> <p>Remove the sample from the pan.</p>
		<p>Weighing pan Error</p> <p>The weight value is too light.</p> <p>Confirm that the weighing pan is properly installed and calibrate.</p>
		<p>Sample mass error</p> <p>The balance can not store the sample for the counting mode or for the percent mode because it is too light.</p> <p>Use a larger sample.</p>
  		<p>Unit mass error</p> <p>The sample unit mass for the counting mode is too light. Storing and using it for counting will cause a counting error.</p> <p>Add samples to reach the specified number and press the PRINT key.</p> <p>Pressing the PRINT key without adding samples will shift the balance to the counting mode. But, to acquire accurate weighing, be sure to add samples.</p>
		<p>Automatic response adjustment zero error</p> <p>The automatic response adjustment can not be performed because there is something on the pan.</p> <p>Clear the pan. Press the CAL key to return to the weighing mode.</p>
 (CHECK NG)		<p>Automatic response adjustment unstable error</p> <p>The automatic response adjustment can not be performed because the weight value is unstable.</p> <p>Check the ambient conditions such as breeze, vibration and magnetic fields, also check the weighing pan. Press the CAL key to return to the weighing mode.</p>
 (CHECK NO)		<p>Internal error</p> <p>Indicates an internal error as the result of self-check function.</p> <p>Repair is required. Contact the local A&D dealer.</p>

Display	Error code	Description
		<p>Clock battery error</p> <p>The clock backup battery has been depleted.</p> <p>Press any key and set the time and date. The clock and calendar function works normally as long as the AC adapter is connected to the balance. If this error appears frequently, contact the local A&D dealer.</p>
		<p>Memory full</p> <p>The amount of weighing data in memory has reached the maximum capacity.</p> <p>Delete data in memory to store new data. For details, refer to "11. DATA MEMORY".</p>
		<p>Memory full</p> <p>The amount of calibration or calibration test data in memory has reached the maximum capacity (50 sets).</p> <p>The data in memory will be deleted automatically to store new data. For details, refer to "11. DATA MEMORY".</p>
		<p>Memory type error</p> <p>Type of memory set in the function table and type of data stored are different.</p> <p>For details, refer to "11. DATA MEMORY".</p>
	EC, E00	<p>Communications error</p> <p>A protocol error occurred in communications.</p> <p>Confirm the format, baud rate and parity.</p>
	EC, E01	<p>Undefined command error</p> <p>An undefined command was received.</p> <p>Confirm the command.</p>
	EC, E02	<p>Not ready</p> <p>A received command can not be processed.</p> <p>e.g. The balance received a Q command, but not in the weighing mode.</p> <p>e.g. The balance received a Q command while processing a RE-ZERO command.</p> <p>Adjust the delay time to transmit a command.</p>
	EC, E03	<p>Timeout error</p> <p>If the timeout parameter is set to "t-UP 1", the balance did not receive the next character of a command within the time limit of one second.</p> <p>Confirm the communication.</p>
	EC, E04	<p>Excess characters error</p> <p>The balance received excessive characters in a command.</p> <p>Confirm the command.</p>

Display	Error code	Description
	EC, E06	Format error A command includes incorrect data. e.g. The data is numerically incorrect. Confirm the command.
	EC, E07	Parameter setting error The received data exceeds the range that the balance can accept. Confirm the parameter range of the command.
Other errors		If the errors described above can not be released or other errors are displayed, contact the local A&D dealer.
Other symbol		
		When this indicator blinks, automatic self calibration is required. The indicator blinks when the balance detects changes in ambient temperature. If the balance is not used for several minutes with this indicator blinking, the balance performs automatic self calibration. The blinking period depends on the operating environment.

19-3 Asking For Repair

If the balance needs service or repair, contact the local A&D dealer.

The balance is a precision instrument. Use much care when handling the balance and observe the following when transporting the balance.

- Use the original packing material.
- Remove the weighing pan from the main unit.

20. SPECIFICATIONS

	GX-200	GX-300	GX-400	GX-600	GX-800	GX-1000
Weighing capacity	210 g	310 g	410 g	610 g	810 g	1100 g
Maximum display	210.084 g	310.084 g	410.084 g	610.084 g	810.084 g	1100.084 g
Minimum weighing value (1 digit)	0.001 g					
Repeatability (Standard deviation)	0.001 g					
Linearity	±0.002 g			±0.003 g		
Stabilization time (typical at FAST)	Approx. 1 second				Approx. 1.5 seconds	
Sensitivity drift (10°C-30°C/50°F-86°F)	±2 ppm/°C (When automatic self calibration is not used)					
Accuracy right after calibration using the internal mass. See notes below	±0.010 g					
	The value above is to the weighing capacity.					
Operating environment	5°C to 40°C (41°F to 104°F) 85%RH or less (No condensation)					
Display refresh rate	5 times/second or 10 times/second					
Counting mode	Minimum unit mass					
	Number of samples					
Percent mode	Minimum 100% reference mass				0.001 g	
	Minimum 100% display					
External calibration weight	200 g	300 g	400 g	600 g	800 g	1000 g
	100 g	200 g 100 g	300 g 200 g	500 g 400 g 300 g 200 g	700 g 600 g 500 g 400 g 300 g 200 g	900 g 800 g 700 g 600 g 500 g 400 g 300 g 200 g
Weighing pan	128 x 128 mm					
Net weight	Approx. 4.6 kg					
External dimensions	210 (W) x 317 (D) x 86 (H) mm					
AC adapter	Confirm that the adapter type is correct for the local voltage and power receptacle type					
Power consumption	Approx. 11VA (supplied to the AC adapter)					
Interface (Provided as standard)	RS-232C with Windows Communication Tools WinCT					

Notes

- Accuracy right after calibration using the internal mass in good ambient conditions (within the temperature range of 10°C to 30°C (50°F to 86°F) with no abrupt changes in temperature or humidity, no drafts, no effect by magnetic fields or static electricity).
- The internal mass has a mass of approximately 500 grams.
- Check the internal mass periodically as described in “18. MAINTENANCE”.

	GX-2000	GX-3000	GX-4000	GX-6100	GX-6000	GX-8000
Weighing capacity	2100 g	3100 g	4100 g	6100 g	6100 g	8100 g
Maximum display	2100.84 g	3100.84 g	4100.84 g	6100.84 g	6108.4 g	8108.4 g
Minimum weighing value (1 digit)	0.01 g				0.1 g	
Repeatability (Standard deviation)	0.01 g				0.1 g	
Linearity	±0.02 g			±0.03 g	±0.1 g	
Stabilization time (typical at FAST)	Approx. 1 second			Approx. 1.5 s	Approx. 1 second	
Sensitivity drift (10°C-30°C/50°F-86°F)	±2 ppm/°C				±5 ppm/°C	
	(When automatic self calibration is not used)					
Accuracy right after calibration using the internal mass. See notes below	±0.10 g	±0.15 g			±0.5 g	
	The value above is to the weighing capacity.					
Operating environment	5°C to 40°C (41°F to 104°F) 85%RH or less (No condensation)					
Display refresh rate	5 times/second or 10 times/second					
Counting mode	Minimum unit mass	0.01 g			0.1 g	
	Number of samples	10, 25, 50 or 100 pieces				
Percent mode	Minimum 100% reference mass	1.00 g			10.0 g	
	Minimum 100% display	0.01%, 0.1%, 1% (Depends on the reference mass stored.)				
External calibration weight	2000 g 1000 g	3000 g 2000 g 1000 g	4000 g 3000 g 2000 g	4000 g 3000 g 2000 g	6000 g 5000 g 4000 g 3000 g 2000 g	8000 g 7000 g 6000 g 5000 g 4000 g 3000 g 2000 g
Weighing pan	165 x 165 mm					
Net weight	Approx. 5.1 kg					
External dimensions	210 (W) x 317 (D) x 86 (H) mm					
AC adapter	Confirm that the adapter type is correct for the local voltage and power receptacle type					
Power consumption	Approx. 11VA (supplied to the AC adapter)					
Interface (Provided as standard)	RS-232C with Windows Communication Tools WinCT					

Notes

- Accuracy right after calibration using the internal mass in good ambient conditions (within the temperature range of 10°C to 30°C (50°F to 86°F) with no abrupt changes in temperature or humidity, no drafts, no effect by magnetic fields or static electricity).
- The internal mass has a mass of approximately 500 grams.
- Check the internal mass periodically as described in “18. MAINTENANCE”.

21. OPTIONS

AD-8121B Printer

- Compact dot-matrix printer
- Statistical function, clock and calendar function, interval print function, graphic print function, dump print mode
- 5 x 7 dots, 16 characters per line
- Print paper (AX-PP143, 45 (W) x 50 (L) mm , ø65 mm)
- AC adapter or alkaline battery.

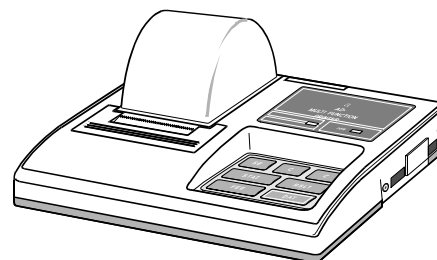

Glass Breeze Break (GX-10)

For GX-200/300/400/600
800/1000

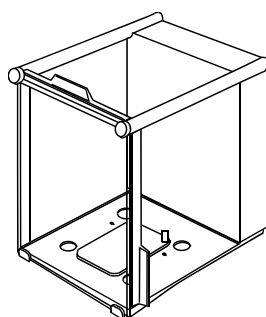

Glass Breeze Break (GX-11)

For GX-2000/3000/4000/
6100/6000/8000

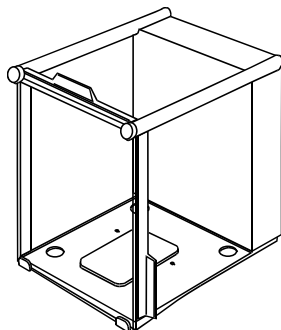

Animal Weighing Bowl Kit (GX-12)

For all models except GX-200
(The mass of the Animal Weighing
Bowl Kit is approx. 200g.)

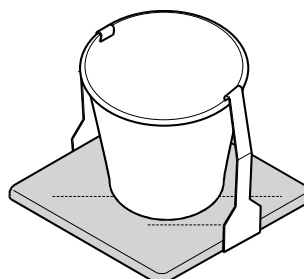

Density Determination Kit (GX-13)

Only for GX-200/300/400/600
800/1000

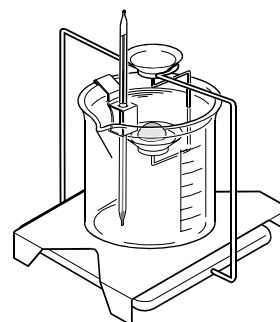

AD-1682 Rechargeable battery

- Allows use of the balance in a place where AC power is not available.

AD-1683: DC static eliminator

- Used to minimize weighing errors due to static electricity on the material.

AD-8524A/B: Keyboard adapter

- Used to connect the balance to a personal computer for communication. Applicable to OS such as MS-DOS, WINDOWS and BASIC, and applications such Lotus 1-2-3 and Excel.

AD-8920: Remote display

- Connected to the GX series using the RS-232C interface to display the weighing data away from the balance.

AD-8922: Remote controller

- Connected to the GX series using the RS-232C interface to display the weighing data and to remotely control the balance.

AX-SW128: Foot switch

- Used to externally transmit a RE-ZERO or PRINT signal to the balance.

Options installed at the factory before shipment:

GX-04: Comparator output with a buzzer / RS-232C / Current loop output

- Used to compare weighing data and output the results.

GX-06: Analog output / Current loop output

- Used to output the weighing data as an analog voltage.

22. EXTERNAL DIMENSIONS

GX-200/300/400/600/800/1000

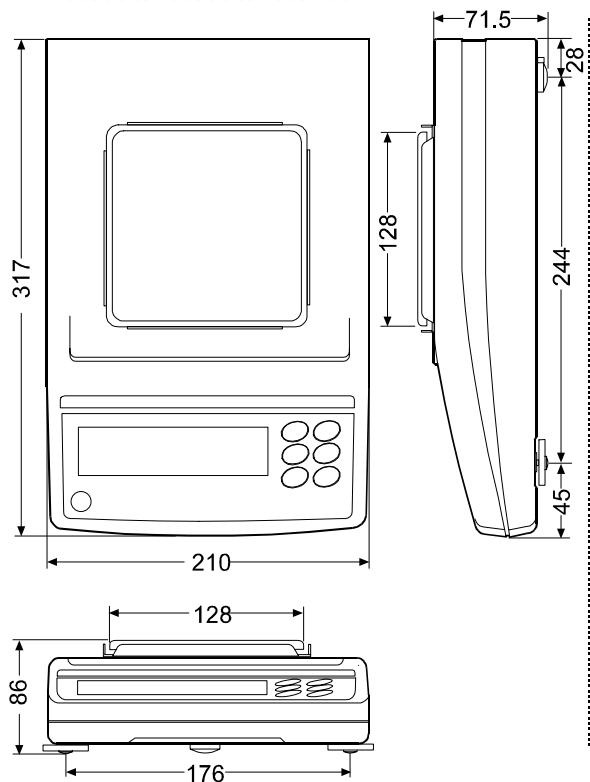

GX-2000/3000/4000/6100/6000/8000

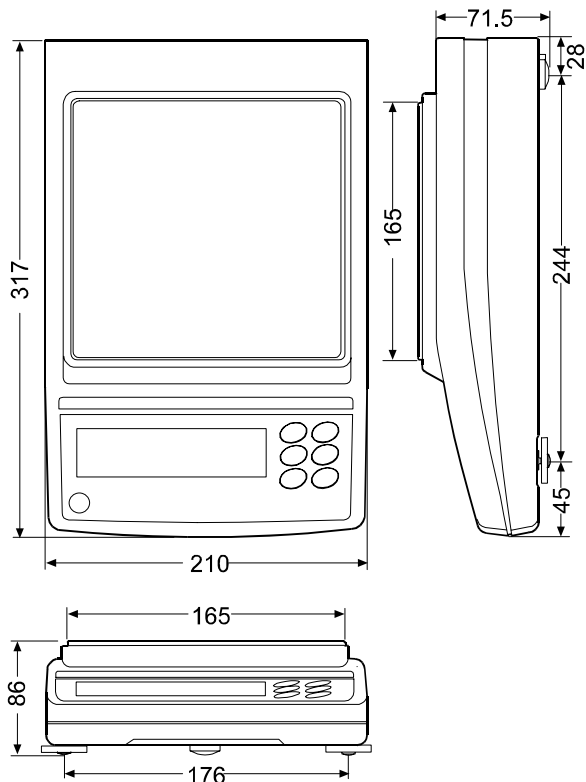











23. TERMS/INDEX

Terms

Stable value	The weight data when the stabilization indicator appears.
Environment	Ambient conditions such as vibration, drafts, temperature, static electricity and magnetic fields which affect the weighing operation.
Store	To save the weighing data, unit mass or calibration data using the data memory function.
Calibration	Adjustment of the balance so that it can weigh accurately.
Output	To output the weighing data using the RS-232C interface.
Zero point	A weighing reference point or the zero display. Usually refers to the value displayed when nothing is on the weighing pan.
Data number	Numbers assigned sequentially when weighing data or unit weight is stored.
Digit	Unit of digital resolution. Used for the balance, a unit of minimum weighing value.
Tare	To cancel the weight of a container which is not included in the weighing data.
Mode	Balance operational function.
Re-zero	To set the display to zero.
GLP	Good Laboratory Practice.
Repeatability	Variation in measured values obtained when the same weight is placed and removed repetitively. Usually expressed as a standard deviation. e.g. Standard deviation=1 digit: This means that measured values fall within ± 1 digit in the frequency of about 68%.
Stabilization time	Time required after a sample being placed, until the stabilization indicator illuminates and the weighing data is displayed.
Sensitivity drift	An affect that a change in temperature causes to the weighing data. Expressed as temperature coefficient. e.g. Temperature coefficient = 2 ppm/ $^{\circ}\text{C}$: If a load is 500 g and the temperature changes by 10°C , the value displayed changes by the following value. $0.0002\%/^{\circ}\text{C} \times 10^{\circ}\text{C} \times 500 \text{ g} = 10 \text{ mg}$

Index

Keys and symbols

	CAL key	10, 23
	MODE key	10, 11
	ON/OFF key	10
	PRINT key	1-
	RE-ZERO key	9, 10
	SAMPLE key	10
	Interval memory active indicator....	10
	Interval memory standby indicator	10
	Prior notice indication of automatic self calibration.....	10
	Processing indicator	10
	Stabilization indicator	10

- A -

A&D standard format	39
ACAI	16
AD-1682	77
AD-8121B	65, 77
AD-8524A/B	77
AD-8920	77
Animal mode indicator	10
Auto display-OFF	37
Auto display-ON	37
Automatic Response Adjustment.....	18
Automatic Self Calibration	22
Auto print mode	38
AX-SW128.....	64, 77

- C -

Calibration	20, 22, 23,24,25
Calibration test	26
Capacity indicator	10, 37
Comparator indicators	10
Comparator function	46
CSV format.....	40

- D -

Data memory	52
Data number.....	41
Digit	24, 25,37
DP format	39

- E -

EC, E00	73
---------------	----

EC, E01	73
EC, E02	73
EC, E03	73
EC, E04	73
EC, E06	74
EC, E07	74
EC, E11	71
EC, E16	71
EC, E17	71
EC, E20	72
EC, E21	72
External input.....	64

- G -

Glass breeze break.....	77
GLP	3, 48
GX-04	78
GX-06	78
GX-10	77
GX-11	77
GX-12	77
GX-13	77

- H -

Hold function.....	17, 36
--------------------	--------



- I -

ID number	39, 46
Inhibit	28
Initializing the Balance	29
Interface.....	61
Interval memory mode	36

- K -

Key mode	38
KF format.....	39

- L -

Linearity	70, 75, 76
	15, 17
	46

- M -

Memory full	73
MT format	40

- N -		Stabilization time	75, 76, 79
NU format	40	Stable value	18, 36, 79
- O -		Static electricity	8, 9, 71
100% reference mass.....	17	Stream mode	38
- P -		- U -	
Percent Mode	17	Underhook	8, 58
Permit	30	Unit mass	15
- R -		Units	11
Repeatability.....	75, 76, 79	- W -	
Response characteristic	18	Warm up	7, 8, 9, 23, 37
RsCom	66	Weighing capacity.....	9, 12, 37, 72, 75, 76
RsKey	66	Weighing pan	6, 7
- S -		- Z -	
Self check function	18	Zero point.....	25, 27, 37, 79
Sensitivity drift	75, 76, 79	Zero tracking.....	37
Stability band width.....	36		

