

HR-SERIES

INSTRUCTION MANUAL

PRECISION ELECTRONIC BALANCE

HR-60

HR-120

HR-200

HR-202

HR-300

AND



This is information mark that inform to you about the operation of balance.



This is notice mark that inform to you on the operation of balance.



This is hazard mark.



Contents

Introduction	3
Features	3
Options and Accessories	3
Compliance with FCC Rules	3
Unpacking your Balance	4
Balance Location	6
Best conditions for weighing	6
Setting up your Balance	7
Taking care of the Balance	7
Power Supply	7
Display ON:OFF & Power Errors	7
Keys and Displays	8
Displays	8
Keys	8
Units	9
Weighing Units and their Conversions	9
Selecting the Weighing Units	10
Weighing	11
Simple Weighing	11
Counting Mode (pcs)	12
Selecting the quantity to be used as a sample	13
ACAI Automatic Counting Accuracy Improvement	14
ACAI Notes	15
Counting Mode using Digital Input of Unit Weight	16
Percent Mode (%)	17
Percent Mode (%) with Digital Input of 100% Weight	18
Environment Response Adjustment	19
Conditions of response	19
Calibration	20
Displays and cancelling calibration	20
Manual Calibration	21
Zero-point-Calibration	22

Functions -----	24
C-parameter keys and displays -----	24
Internal parameter setting -----	25
C-parameter settings -----	26
Miscellaneous -----	28
Digital Tare -----	28
The ID number -----	29
External key connector -----	30
Underhook weighing -----	31
An example of underhook weighing -----	31
Errors -----	32
Specifications -----	34
Specifications -----	34
External Dimensions -----	35
Index -----	37

Introduction

*Thank You For Your **AND** Purchase*

Electronic Balances are easy to use, yet they are rather complex in that they are high technology products. This manual will tell you in simple language how this balance works and how to get the most out of it in terms of performance.

Features

- The HR-202 is dual range balance (42g / 0.01mg, 210g / 0.1mg).
- The HR-300 / 200 / 120 / 60 (310~60g / 0.1mg) are single range balances.
- The HR series can be easily adapted to most operating environments through simple adjustments from the keyboard.
- The OP-03 serial interface allows control of the balance or transmission of the weighing data to a computer or printer.
- Good Laboratory Practices (GLP) calibration output using the OP-03 / 05 serial interface.
- A calibration mass correction function allows precise input of the calibration mass.
- Multiple weighing units, with most of the common units used around the world.
- Counting (pcs) mode, for inventorying lightweight components or pharmaceuticals.
- Percent (%) mode, for matching weights against a standard.
- Digital Tare, allows the input of a tare value from the keyboard or via the RS-232C interface.
- Security, the serial number of the balance is available using the RS-232C interface.

Options and Accessories

- OP-03 Serial interface, bi-directional RS-232C/ Current Loop.
- OP-05 Current Loop printer interface.
- OP-09 Ni-HM battery pack for HR-200 / 120 / 60.
- OP-11 Anti-theft device for HR-202 / 300.
- AD-8121 multi-function printer. This printer can print weighing data, total weighing counting and standard deviation, along with the time and date. Includes statistical calculation.

Compliance with FCC Rules

Please note that this equipment generates, uses and can radiate radio frequency energy. This equipment has been tested and has been found to comply with the limits of a Class A computing device pursuant to Subpart J of Part 15 of FCC rules. These rules are designed to provide reasonable protection against interference when equipment is operated in a commercial environment. If this unit is operated in a residential area it might cause some interference and under these circumstances the user would be required to take, at his own expense, whatever measures are necessary to eliminate the interference. (FCC = Federal Communications Commission in the U.S.A.)



Unpacking Your Balance

- ❑ Unpack the balance carefully and keep the packing material if you want to transport the balance again in the future.
- ❑ In the carton you should find this manual plus:

HR-200 / 120 / 60

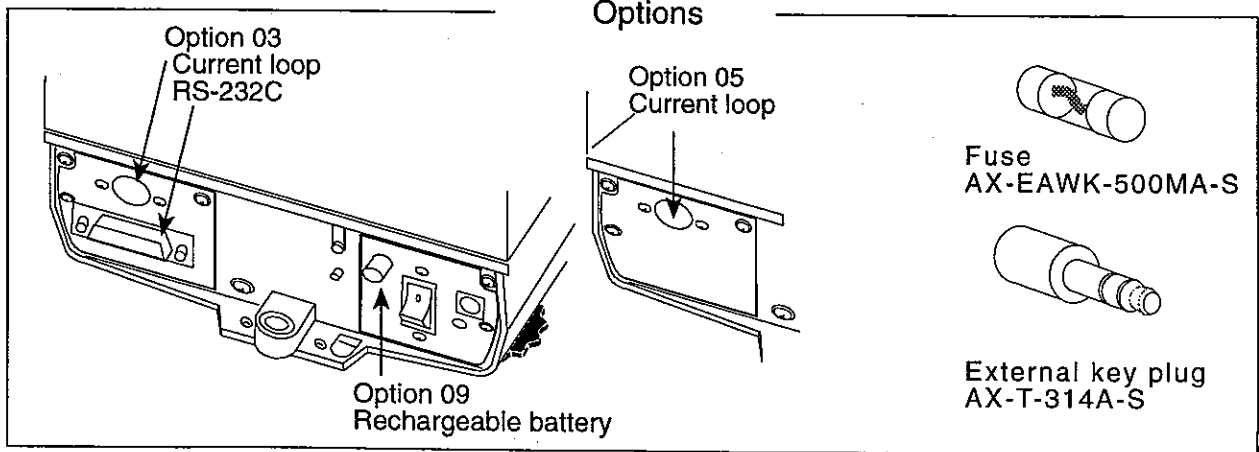
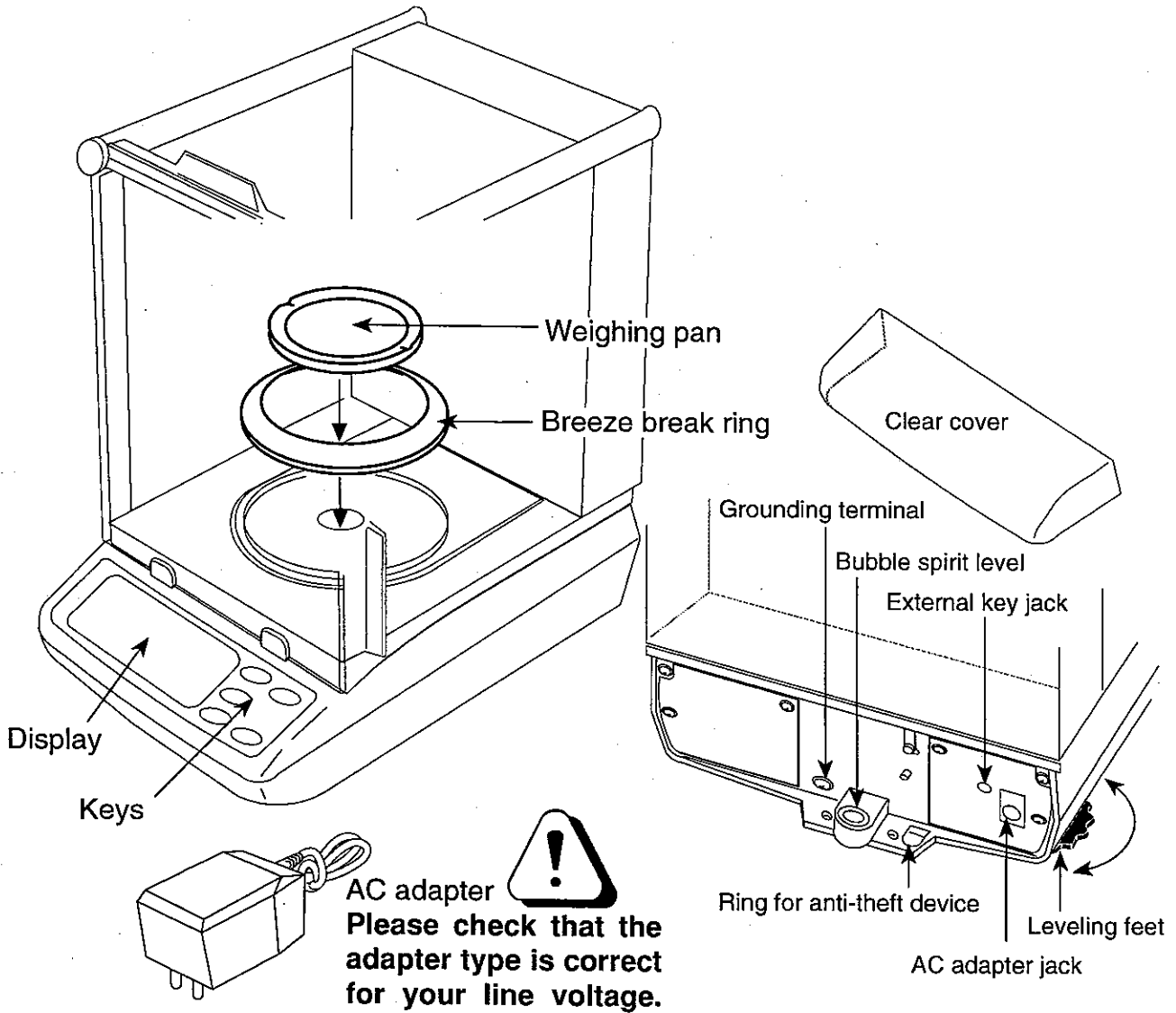

HR-202 / 300

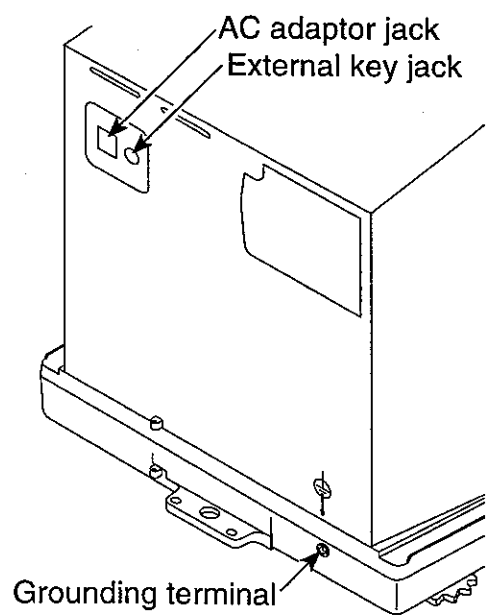
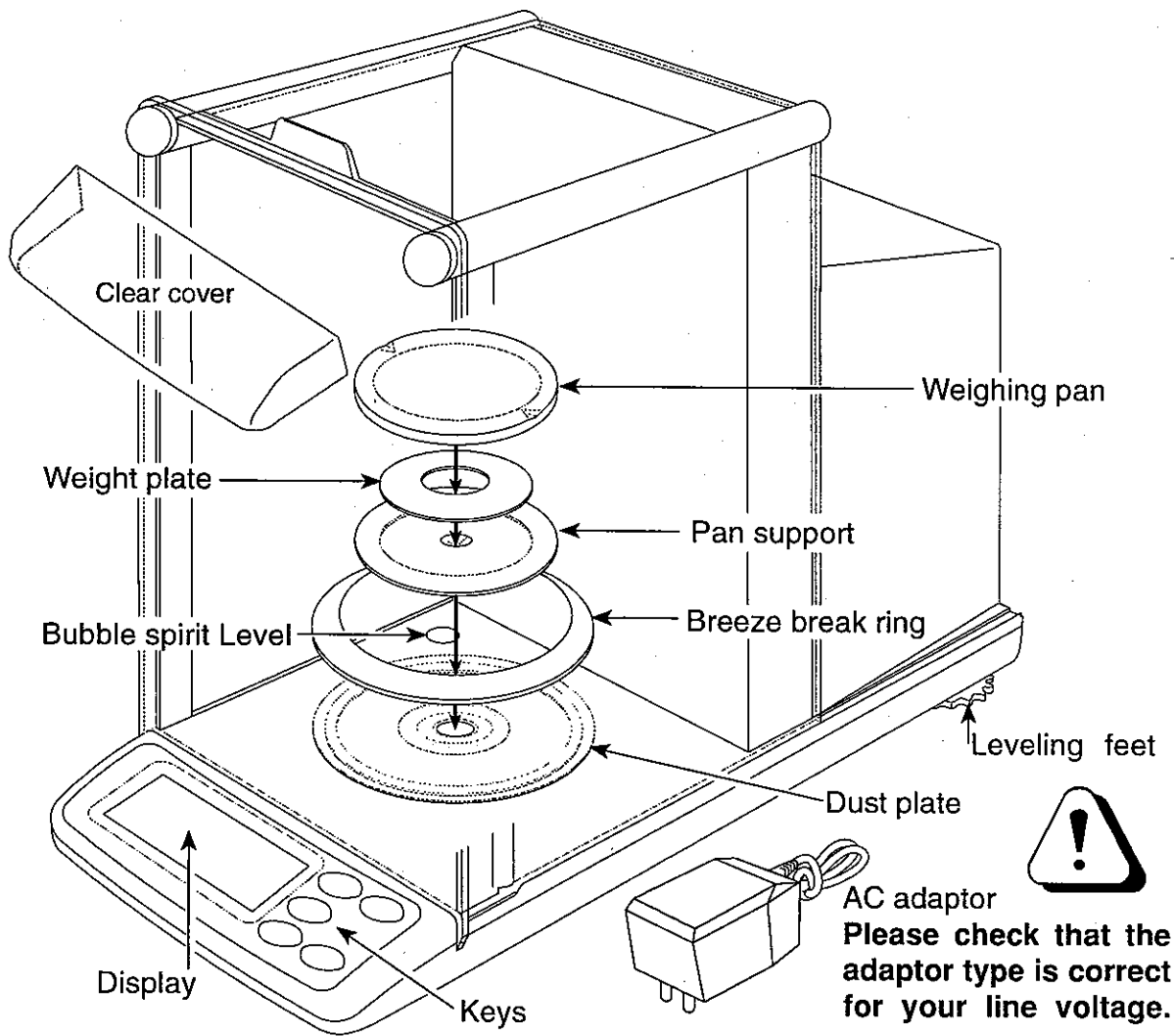



Balance Location

- The weighing table should be solid and free from vibration, drafts (such as frequently opening doors or windows) and as level as possible.
- Corners of rooms are best as they are less prone to vibrations.
- Don't install the balance near heaters or air conditioners.
- Don't install the balance in direct sunlight.
- Don't use the balance near other equipment which produces magnetic fields.
- Try to ensure a stable power source when using the AC adapter.
- The best operating temperature is about 20°C/68°F at about 50% Relative Humidity.



Best conditions for weighing



To ensure that you get the most from your balance, please try to follow these conditions as closely as possible:

- Please warm-up (plug-in) the balance for at least one hour.
- The weighing room should be kept clean and dry.
- Please RE-ZERO the balance before each use to prevent possible error.
- Make each weighing quickly to avoid errors due to changes in environmental conditions.
- Close the breeze break doors to keep out drafts.
- Do not drop things upon the weighing pan, or place a weight beyond the range of the balance on the weighing pan.
- Do not use a sharp instrument (such as a pencil or ball point pen) to press the keys, use only your finger.
- Use caution when weighing items that could have a static charge (plastics, insulator, etc.), as the weight of a material that has a static charge is influenced by its surroundings. Try to keep the ambient humidity above 45%RH and to use the metal shield case.
- This balance uses a strong magnet as part of the balance assembly, so please use caution when measuring magnetic materials. If there is a problem, use the underhook assembly (on the bottom of the balance) to suspend the material away from the influence of the magnet.
- When weighing a sample that is either warmer or cooler than the ambient temperature, the sample can set up a draft due to the air rising or falling next to the sample. This draft can cause a shift in the weight of the sample.
- Due to the affect of air buoyancy on a sample, please take this into account when absolute accuracy is required.
- There are two methods of pressing a key. The first, is to press and release a key; and the second, is to press and hold a key. Each of these will perform a different function. Please refer to your instruction manual to learn the functions of the keys. Take special care with the **RE-ZERO** key, because if it is pressed and held, the balance will enter the calibration mode which could cause you to reset calibration improperly.

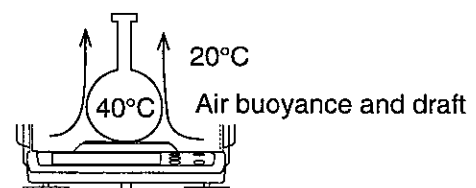
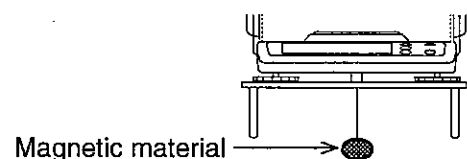
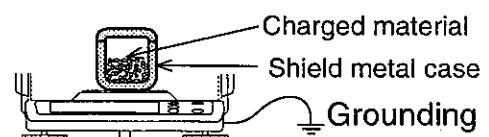

Setting up your Balance

- Place the balance on a firm weighing table and turn the adjustable feet until the balance is level (check the spirit level on the balance).
- Install the weighing pan and breeze break ring on the balance (see the section on "Unpacking Your Balance").



Please check that the adapter is the correct voltage. Plug in the AC adapter. Ground the balance chassis for electrostatic discharge if static electricity could be a problem.

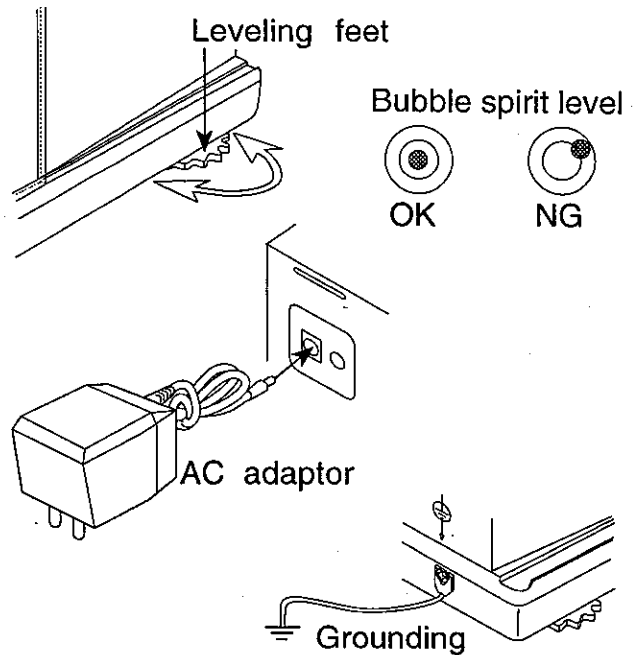

Taking care of the Balance



Don't drop the balance. The balance will be damaged.

Don't drop anything on the weighing pan. The balance could be damaged.

- Don't disassemble the balance. Contact your local A&D dealer if your balance needs service or repair.
- Don't use solvents to clean the balance. A lint free cloth is best for cleaning, using warm water with a mild detergent.
- Keep equipment containing magnets away from the balance.
- Protect the internal parts from liquid spills and excessive dust.
- Please use a very precise calibration mass.

Power Supply

When the AC adapter is connected, the balance is in the standby mode if the standby indicator is on (see "Displays" on the next page). This is a normal state and does not harm the balance. We recommend that you plug in your balance for at least an hour before use so it can warm up.

Display ON:OFF & Power Errors

- The balance does a self check when you connect the AC adapter or press the **ON:OFF** key. If there is a problem, you will get an error display. Please refer to the error code table. $P - F R I L$ will be displayed if the power was cut with the display on. To clear this error, press the **ON:OFF** key.

Keys and Displays



This section explains the keys and displays for the weighing mode. Refer to the following separate sections for an explanation of the Percent (%), and Counting (pcs) Modes.



Displays

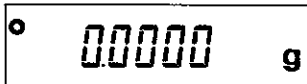

Normal weighing display of zero. Please read weighing data only after the stabilization mark is displayed.

Note: the number of decimal places depend on the model in use.

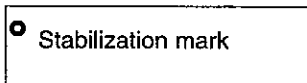

Stabilization mark

This round symbol is the stabilization mark. It is displayed when the balance is stable and the weighing data can be read. Refer to "Stability Band Width" Function.

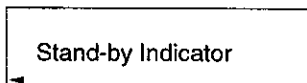

Stand-by Indicator

This is the Stand-by Indicator. This mark is displayed when you turn the display off, and the AC adapter still connected.



Keys



The **ON:OFF** key switches the display ON and OFF but does not cut the power to the balance. The balance will remain on standby (warm up) while the AC adapter remains connected.



The **RE-ZERO** key is used to zero the display within the range of the balance. This key returns the balance to the center of zero when the weighing pan is empty, and can also tare total weight (container and sample). Please use this key before each weighing to cancel possible error.



The **RANGE** key can also be used to turn ON/OFF the least significant digit alternatively. This key switches the HR-202 weighing range.

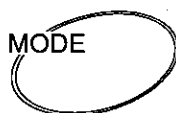

If you press the **MODE** key, the balance switches between weighing modes. However, only selected modes will be displayed.

If you press and hold the **MODE** key, the balance changes the adjustment mode to a new weighing environment. This mode sets the response of the balance. This parameter is common to the "Response / Environment" function and "Condition of response". Refer to this function and "Condition of response".



The **PRINT** key can be used to output data to a printer or personal computer if the RS-232C or current loop is installed. Please refer to section "Functions" for details of output format and setting up the balance.



Units

The most common unit of weight used around the world is grams, but there is often a need to shift to an alternative unit specific to the country where the balance is used or to select modes such as counting or percent.

The **MODE** key is used to switch between these Units. The complete weighing mode cycle is as follows (if some are missing please refer to your dealer):

If a mode or unit of weight has been turned off, the sequence will be missing that mode or unit. There are also the various Tael and Tola that can be included if necessary. (Tael is selected as a unit from four units available by the factory)

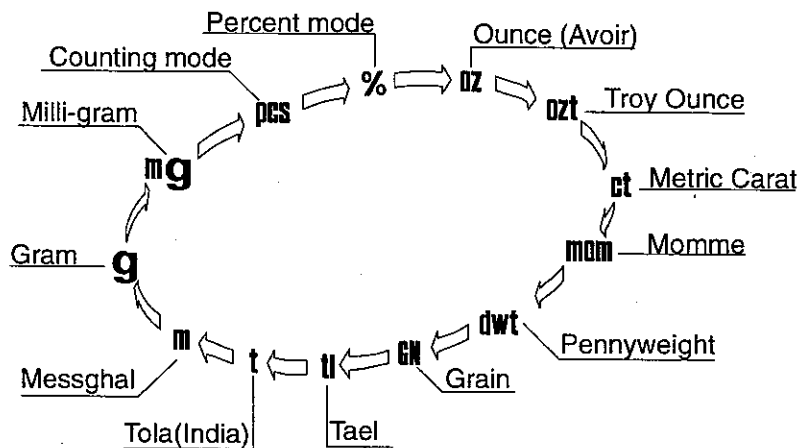

If the law in your area permits, you may use all of the units, or at this software level you can disable the weighing units you don't regularly use. Also, some dealers may initially turn OFF units which are not regularly used, but you may want to turn them back on.



Weighing Units and their Conversions

Abbrev.	Name	Conversion
mg	Milli-gram	0.001g
oz	Ounce (Avoir)	28.3495231g
ozt	Troy Ounce	31.1034768g
ct	Metric Carat	0.2g
mom	momme	3.75g
dwt	Pennyweight	1.55517384g
GN	Grain (UK)	0.06479891g
tl	Tael (HK general, Sing.)	37.7994g
tl	Tael (HK, jewelry)	37.429g
tl	Tael (Taiwan)	37.5g
tl	Tael (China)	31.25g
t	Tola (India)	11.6638038g
mes	Messghal	4.6875g



Selecting the Weighing Units

- 1** Turn off the display
- 2** Press and hold the **MODE** key, and press the **ON:OFF** key. The balance will display the test mode and then "Unit".
- 3** Select the modes you want active using the following keys:

MODE key to step through the modes

RANGE key to select the mode

ON:OFF key to cancel updating the new selection.

- 4** Press the **PRINT** key to store the modes selected and return to normal display.

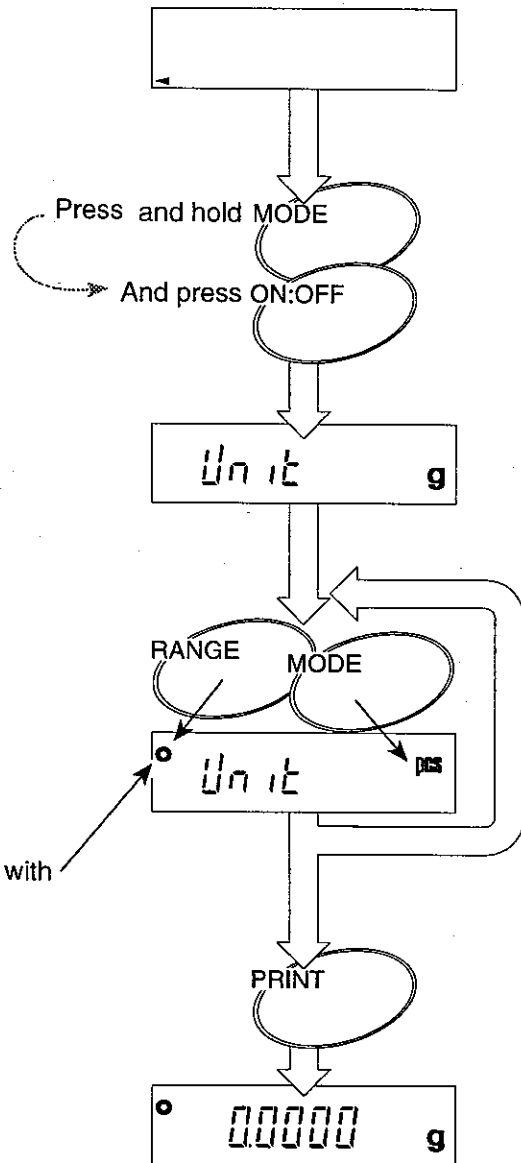



Weighing



For accurate weighing, please warm up the balance for an hour before use and try to meet "Best conditions for weighing".



Simple Weighing

- 1 Turn the display on using the **ON:OFF** key. After a moment "zero" will be displayed.

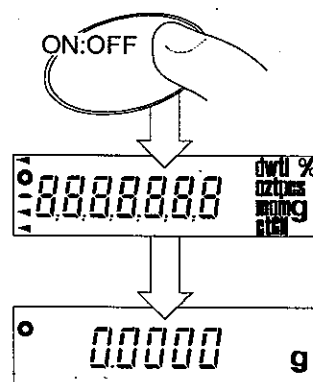

- 2 If you are using a tare container, place it on the weighing pan. The display will show the container weight.

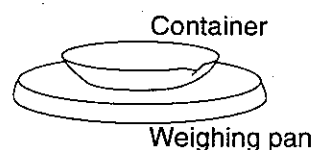

- 3 Press the **RE-ZERO** key to cancel the weight.

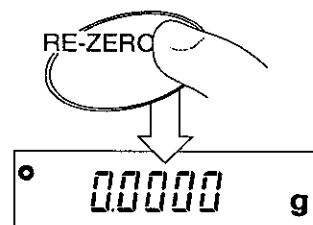

- 4 Place the object to be weighed in the container.

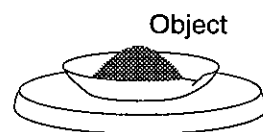

- 5 Wait for the stabilization mark to come on and read the weight.

Stabilization mark

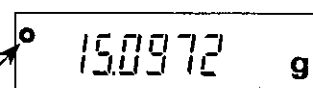

- 6 Remove the object from the pan.

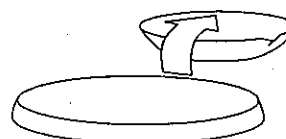

- 7 Turn the display off using the **ON:OFF** key. The display will show the stand-by indicator.

Standby indicator

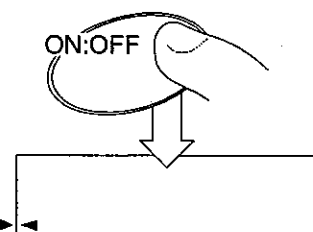

Counting Mode (pcs)

Often there is a need to be able to count small parts or pharmaceuticals. This is usually an inventory function that can be a problem due to the light weight of the individual item.

The HR balance counts by calculating the average weight of one piece-weight called the unit weight, then applying it to the total weight of what you are trying to count. A&D has added exclusive software called ACAI™ (Automatic Counting Accuracy Improvement) that constantly updates the unit weight. It is explained on page 14.

The minimum unit-weight can be stored with is 0.1mg.

This is the step by step process for using the counting function:

- 1 Select "pcs" using the **MODE** key.
If the balance displays "10 x", proceed to the step 3.

In case of no unit data

- 2 If you want to change the unit weight, press the **RANGE** key.

- 3 Place a container on the pan if needed.
Press the **RE-ZERO** key to clear any offset from zero, such as a container to hold the items to be counted.

- 4 Place the sample to be counted on the pan (This will normally be the same quantity as the count displayed).

- 5 Wait for the stabilization mark to come on. Press the **RANGE** key. The balance will store the sample weight. Then the balance will display the counts. (First count will be ten items)

- 6 Remove the sample and container on the pan.

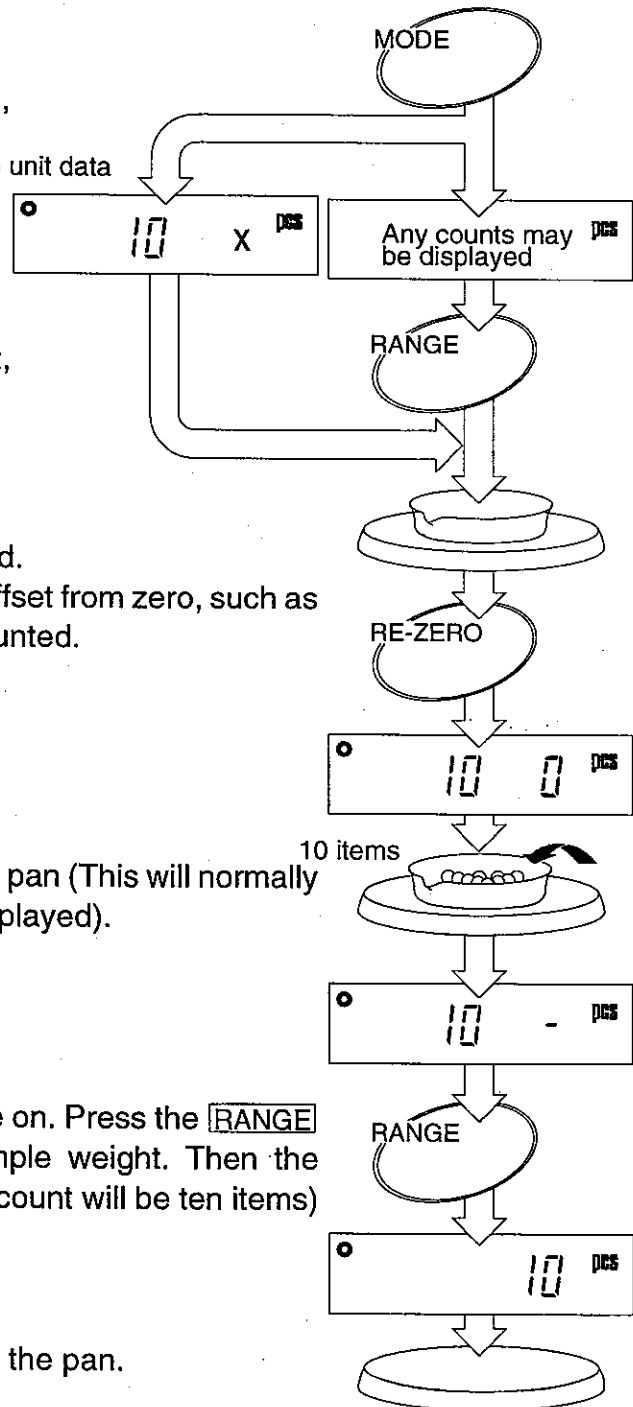



Selecting the quantity to be used as a sample

You can select the quantity to be used as a sample between step 4 and step 6.

- 1 Select "pcs" using the **MODE** key.
If the balance displays "10 x", proceed to the step 3.

- 2 If you want to change the unit weight, press the **RANGE** key.

- 3 Place a container on the pan if needed.
Press the **RE-ZERO** key to clear any offset from zero, such as a container to hold the items to be counted.

- 4 Select the number of items to be used for the sample using the **PRINT** key. This may be set to 10, 20, 30, 40, 50, 60, 70, 80, 90 or 100. (The higher the number, the better the accuracy).

- 5 Place the sample to be counted on the pan (this will normally be the same quantity as the count displayed).

- 6 Wait for the stabilization mark to come on. Press the **RANGE** key. The balance will calculate the unit weight and store it (This value is saved, even if the balance is turned off).

Error

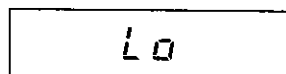

If the sample is very light, the balance may not be able to perform the counting mode.

- 7 Remove the sample and container on the pan.

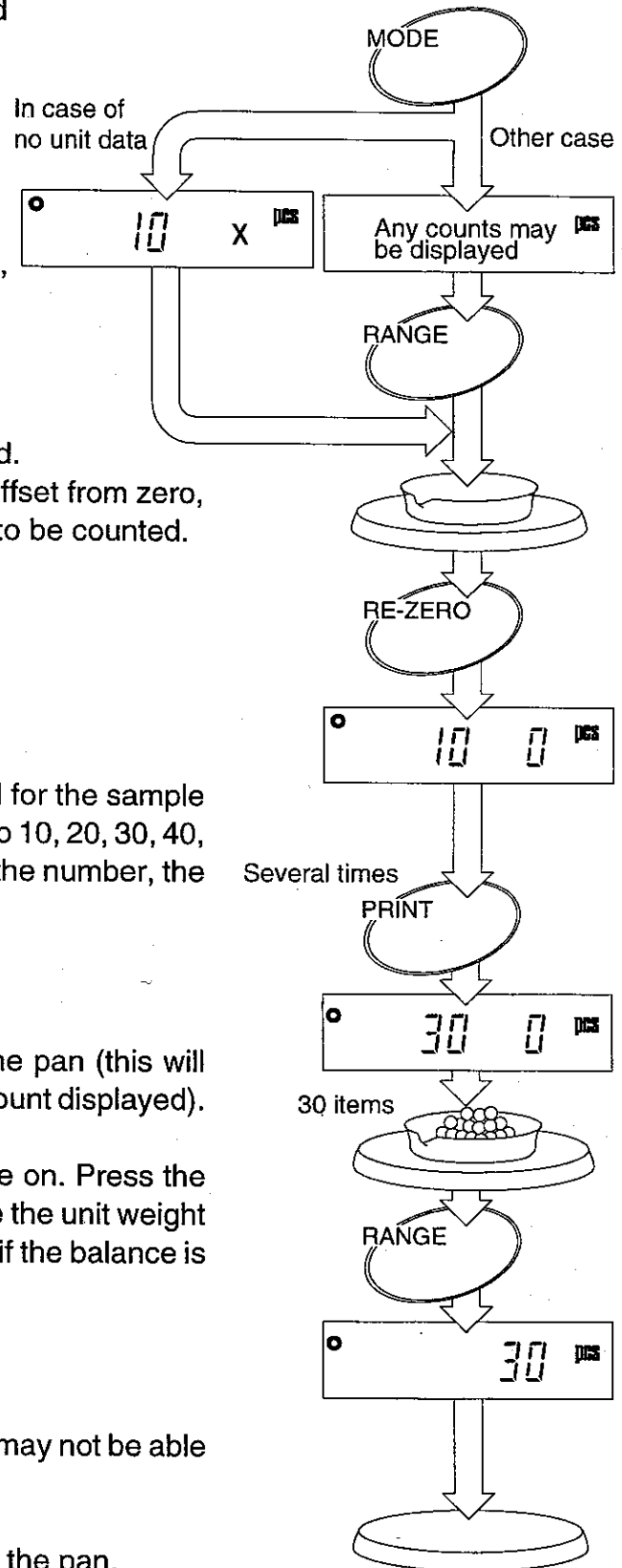

ACAI Automatic Counting Accuracy Improvement

The ACAI™ (Automatic Counting Accuracy Improvement) function re-calculates the unit weight as more items are added, to improve the accuracy.

The ACAI indicator

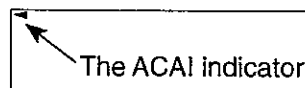

When the balance calculates the unit weight, the higher the number of items in the sample, the higher the accuracy.

Example: If you use 10 very small parts as your sample, with a unit weight of 0.1000 grams calculated by the balance. Using the ACAI feature, after 200 parts were counted, the updated unit weight was .0995 grams. This does not seem like a significant difference, but the count could have been off by 1 part at a count of 200, 2 parts at 400, etc..

$$0.1000 - 0.0995 = 0.0005\text{g}$$

$$0.0005\text{g} \times 200 \text{ parts} = 0.1000\text{g or } 1 \text{ part.}$$

This would not be acceptable if the part is expensive. This would be totally unacceptable to a purchaser if he stopped to count the parts.

To use ACAI, Follow the steps outlined on the previous pages, then follow these steps:

- 1** Add a small number of additional parts (it is not necessary to count the added number). Then the ACAI indicator will blink several times.

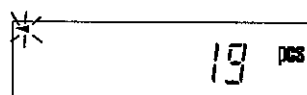

- 2** The balance has updated the unit weight after the display stops blinking. Please wait your next operation until the ACAI indicator stops blinking.



- 3** ACAI stores the corrected unit weight in memory until a new sample is established, or the process is repeated.



Please add these samples according to the table to best use the ACAI function.

Count on the weighing pan	Next total count on the weighing pan	Count on the weighing pan	Next total count on the weighing pan
10	13~26	70	73~118
20	23~47	80	83~128
30	33~65	90	93~138
40	43~81	100	103~148
50	53~95	101~	As necessary, but no less than 3 items greater than the current count
60	63~108		



ACAI Notes

- The ACAI function has the additional range to re-calculate the unit weight as more items are added. The ACAI indicator is blinking in this range. If you use the ACAI function to increase the precision of the unit weight, do not add items while the ACAI indicator is blinking.
ex. If first items is 10, additional range is 13 ~ 26 (total items).
- You must use the ACAI procedure immediately after establishing the unit weight. Do not remove any of the original samples, just continue to add.
- There is no need to actually count the additional items added.
- Do not remove the sample until the ACAI procedure is completed (if you remove the sample, the balance will accept this as the maximum amount that you want the ACAI to correct for).
- The balance will store the unit weight for the next count.
- If you use "Digital Unit of Weight" the balance can not use the "ACAI" mode for counting.

Counting Mode using Digital Input of Unit Weight

If you know the unit weight of the objects to be counted, it may be entered using the keyboard or from a computer using the optional RS-232C interface. This is especially useful when inventorying a warehouse or pharmacy where many different unit weights are already known.

The minimum unit-weight that can be stored is 10mg.

- 1 Select "pcs" using the **MODE** key.
- 2 Press and hold the **RANGE** key to select the unit for the unit of weight. The balance will display " *UU* ".
- 3 Select the unit using the **MODE** key for unit weight.
- 4 Press the **RE-ZERO** key to input the digital unit weight. The balance will display the last unit weight or "....." if there was no unit weight in memory.
- 5 Press the **MODE** key. Then you can enter a new unit weight.
- 6 Select the digit to be changed using the **MODE** key. Press the **RE-ZERO** key to change the value of the digit selected. Continue this process until all of the digits are set correctly.
- 7 Press the **PRINT** key to store the new unit of weight in memory.
- 8 The balance will display " *Pt* " for several seconds, then the count will again be displayed. Continue with your counting.

..... dwt

OR

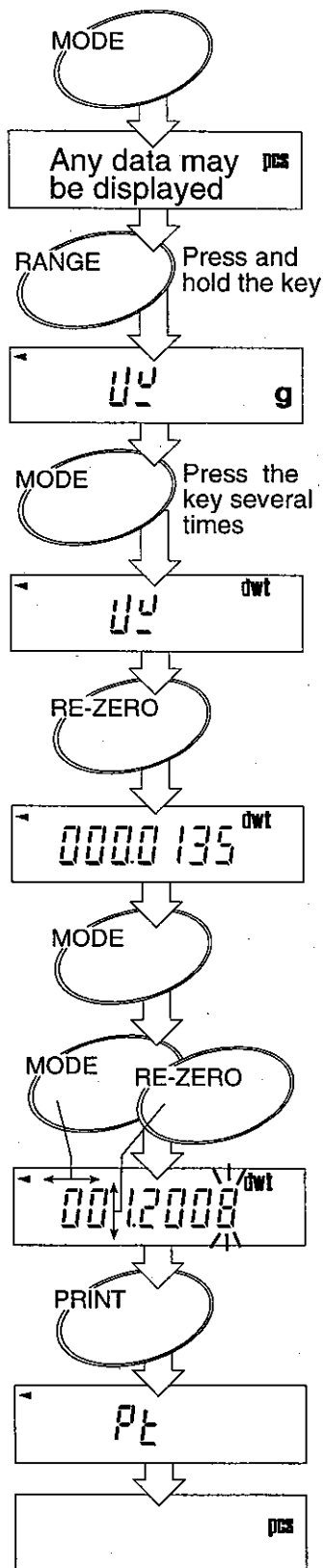

If you use "Digital Unit of Weight" the balance can not use the "ACAI" mode for counting.

Percent Mode (%)



The HR balance has a Percentage mode that allows you to establish a 100% point, and then use this to determine a percentage based on that sample. Less or greater than 100% weight may be displayed at 1%, 0.1% or 0.01%, dependent on the range of digits used.

The minimum unit-weight that can be stored is 10mg.

- 1** Select "%" using the **MODE** key. If the balance displays "100 x", proceed to the step 3.
- 2** If you want to change the 100% weight, press the **RANGE** key to switch to the sample input mode.
- 3** Press the **RE-ZERO** key to set the zero point.
- 4** Place the item to be used as the sample on the pan.
- 5** Press the **RANGE** key. The balance will store the weight of the sample as the 100% point.
- 6** Remove the sample and place another item to be checked on the pan. Wait for the stability indicator to come on and read the percentage.

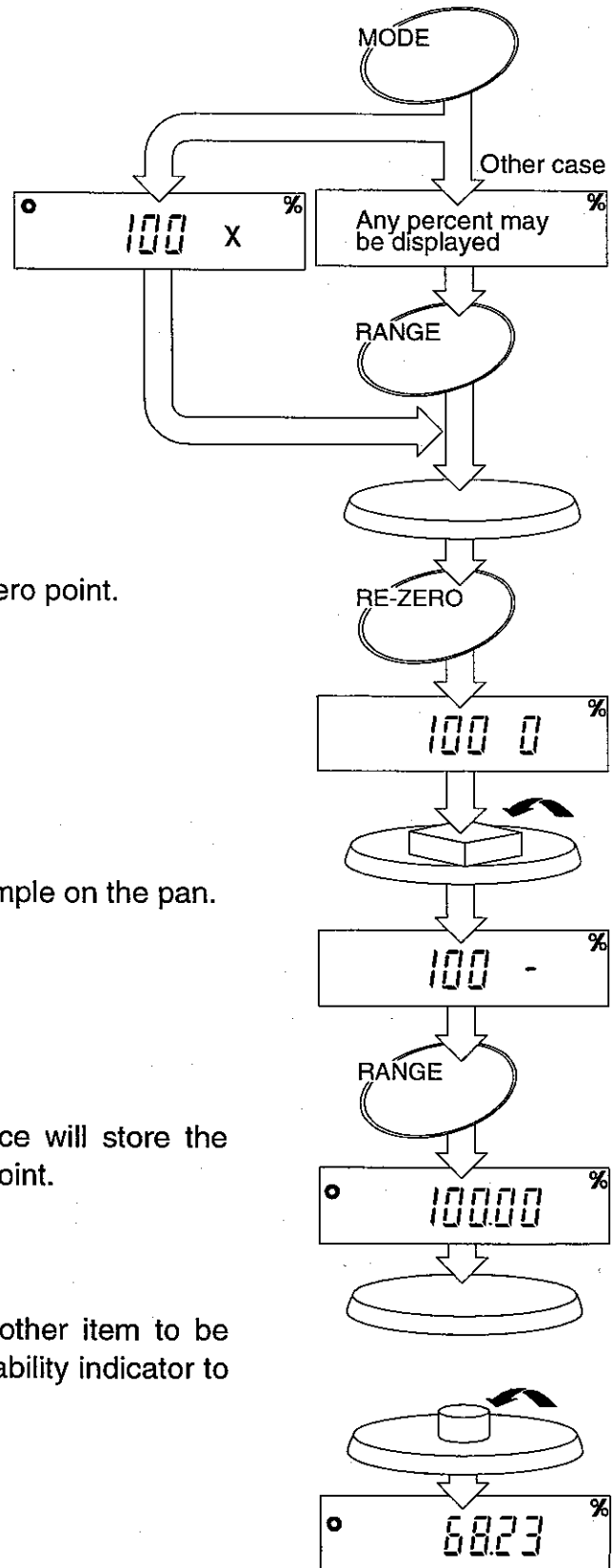

Percent Mode (%) with Digital Input of 100% Weight

The HR balance has a Percentage mode that allows you to enter the 100% weight using the keyboard or a computer (using the optional RS-232C interface) for the percentage sample.

The minimum unit-weight that can be stored is 10mg.

- 1** Select "%" using the **[MODE]** key.
- 2** Press and hold the **[RANGE]** key to switch to the sample input mode. "pu" will be displayed.
- 3** If you would like to use a different weighing unit other than the one shown, Press the **[MODE]** key to select the unit of weight.
- 4** Press the **[RE-ZERO]** key to display 100% weight. If no 100% weight is stored in memory the display will be ".....".
- 5** Press the **[MODE]** key to enter the value setting mode.
- 6** Press the **[MODE]** key to select the digit to change and the **[RE-ZERO]** key to set the value of the digit selected.
- 7** Press the **[PRINT]** key to store this value.

"Pu" will be display for a few seconds, then the balance weighs in percentage mode.

The sample weight for the 100% point is stored in memory and will be retained if the power is turned off.

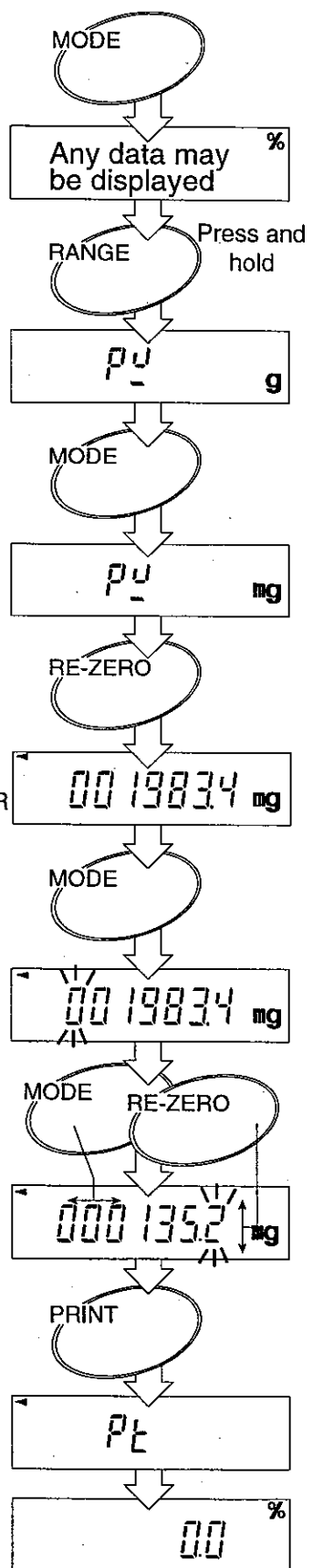



Environment Response Adjustment

The HR series has three functions to adapt the balance to environmental changes.

Condition response

Use this setting when you want a reading as quickly as possible or a reading as stable as possible. This parameter is common data with the "Response / Environment" function. Refer to "Functions" and the Condition of Response procedure.

Calibration

This mode allows recalibration, canceling possible weighing error due to gravity, altitude, air pressure, ambient temperature and humidity using a your calibration mass. Please use a calibration mass sufficiently precise to recalibrate the smallest digit of the display.

Please calibrate the balance when you move it or perform the periodical maintenance. Refer to "Calibration".

Function

The HR series has a number of internal software parameters so that you are able to select the best weighing features for your needs. Refer to "Function".



Conditions of response



In this procedure, If you do not complete the next steps within five seconds, the balance will return to the weighing mode without saving the new parameter.

Conditions Determining Response Rate

Parameter setting	
Cond	0
	1
	*2
	3
	4

↑ better weighing conditions faster weighing response ↓
↑ worse weighing conditions slower weighing response ↓

* factory setting

1 Press and hold the **[MODE]** key. The balance will change to the "Condition of response" mode and the display will show the "Cond".

2 Press the **[RE-ZERO]** key several times until the parameter you want is displayed.

3 Press the **[PRINT]** key. The balance will change to weighing mode, saving the new parameter. This is stored in the balance memory, even if the AC adapter or optional battery is removed from the balance.

This mark displays with a memorized parameter

ex. most stable parameter

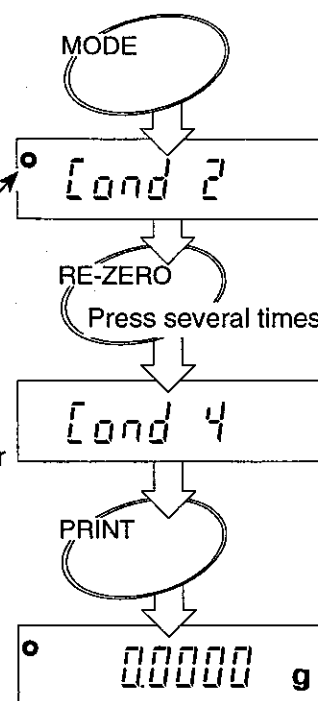



Calibration



Prevent vibration, drafts, and ambient temperature changes from affecting the balance during calibration.

- To get the output for Good Laboratory Practice (GLP) set "output of calibration" (E - 4, INF D) before you perform the calibration.
- Please use a very precise calibration mass. The accuracy of your balance is decided by this calibration mass.
- If you want only zero-point-calibration, a calibration mass is not needed.
- Please select your calibration mass from following table. The preferred calibration mass is the value in bold type and is displayed when the balance enters the calibration mode.

Model - Number

HR-60	50g
HR-120	50g 100g
HR-200	100g 200g
HR-202	100g 200g
HR-300	200g 300g



Displays and canceling calibration



This mark means the balance is proofing calibration data. Do not allow vibration or drafts to affect the balance while this mark is displayed.

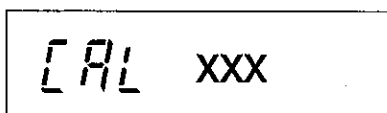

- XXX = [] balance is executing zero-point-calibration.
- XXX = (except zero) shows the required calibration mass weight and means to be executing full-scale-calibration.

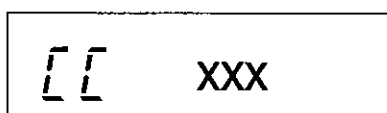

- XXX = [] means to be executing zero-point-check.
- XXX = (except zero) shows the required calibration mass weight and the balance is executing full-scale-check.

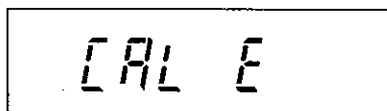

"CAL E" will be displayed if the calibration mass is too heavy.

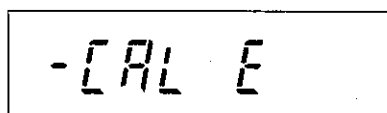

"-CAL E" will be displayed if the calibration mass is too light.

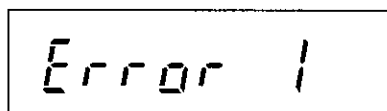

Warning of instability due to vibration or drafts. Please check ambient conditions. See also the conditions. If you choose eg. Cond 3 or 4 you are likely to have a more stable reading.

Manual Calibration

This procedure performs manual calibration using your own calibration mass. This assumes that parameter "[-3, CAL 1 or 2" is set to "Permission of key operation", and that parameter "[-4, INF 0" is set to "No output". This illustration is for model HR-200.

1 Warm up the balance for at least one hour with nothing on the weighing pan. Turn the display on.

2 Press and hold the **RE-ZERO** key to enter calibration mode.

3 Press and hold the **RE-ZERO** key until "CAL" is displayed. Release the **RE-ZERO** key. "CAL" appears to indicate that the balance is in calibration mode. If the balance enters another mode, press the **ON:OFF** key and restart the procedure.

"CAL E5E" is the function to output the calibration condition serially (conforming to GLP) and is only for the balance with the serial output equipped. For details, see the options manual.

4 If you do not want to change the calibration mass weight, proceed to step 8.

If you want to change the calibration mass value, press the **MODE** key.

5 Enter the calibration mass value using the following keys.

MODE key Used to move digit to enter a number.

RE-ZERO key Used to change a number.

6 Press the **PRINT** key. The balance registers the new calibration mass value.

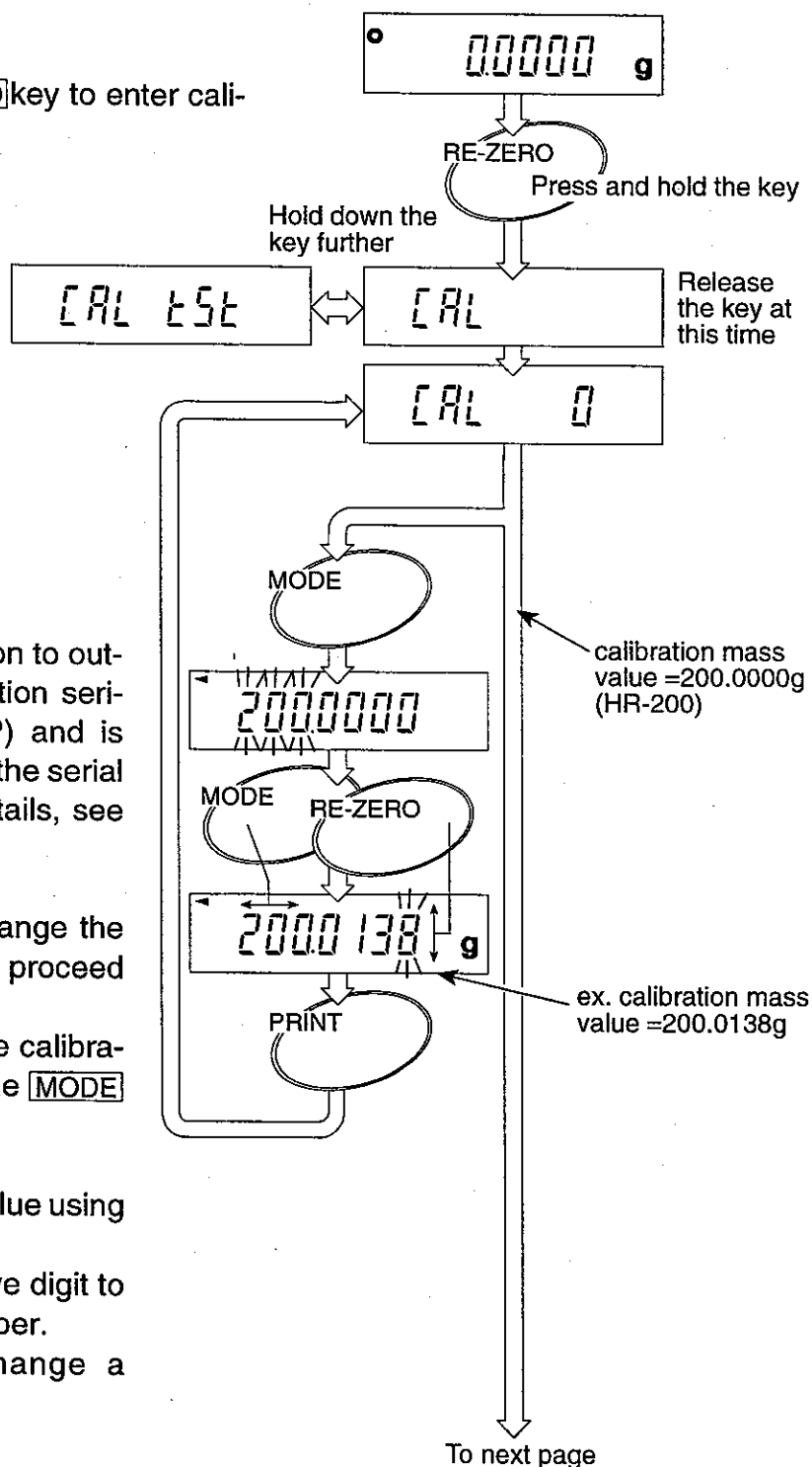

7 In case of storing a new parameter again, return to step 4. Otherwise, proceed to step 8.

8 Verify that there is nothing on the weighing pan.

9 Press the **RE-ZERO** key. The balance measures the zero-point.

10 The balance will display the calibration mass. (**CAL 200**) Place the calibration mass on the pan. Press the **RE-ZERO** key. (If you want to perform zero-point-calibration only, press the **RE-ZERO** key without calibration mass and proceed to step 11.)

The balance measures the calibration mass value.

The manual calibration is finished.

11 Remove the calibration mass from the pan. The balance will return to normal weighing mode automatically.

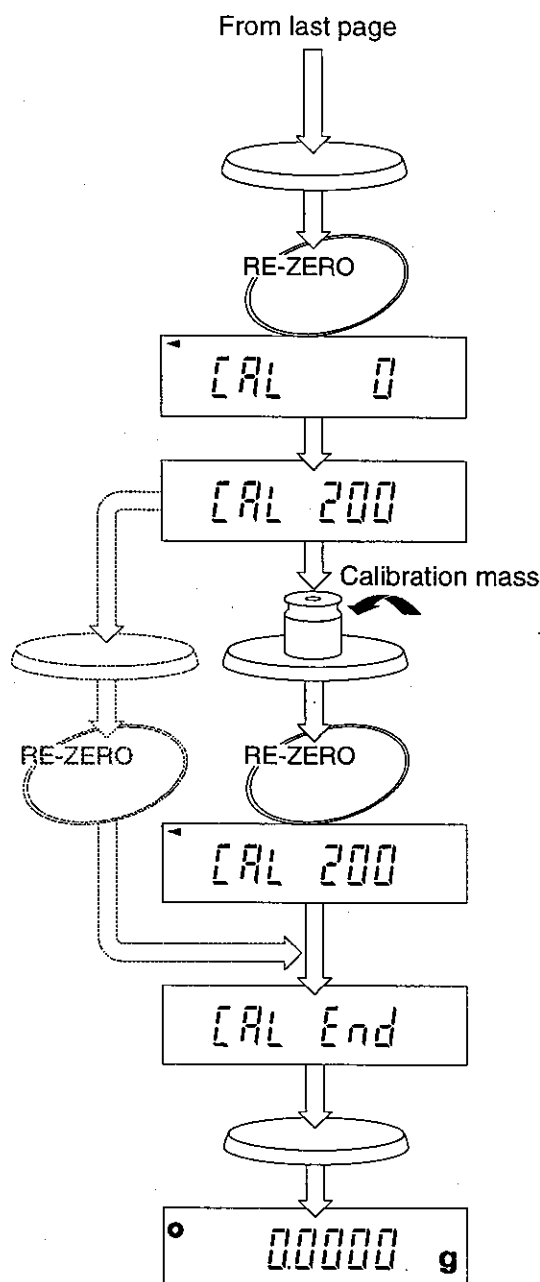

Zero-point-calibration

If the balance displays **-E** when the balance is turned on, with the weighing pan that is in the correct position and on which nothing is placed, it means that the zero point has shifted. It is necessary to perform the Zero-calibration. Refer to the following page.

Caution The decimal point position and/or weight values are different depending on the balance model. The following procedure assumes that the internal settings are set at **[-3] [CAL 2]** and **[-4] [INF 0]** (manufactures setting). Please confirm that you have the proper settings before attempting zero-calibration.

1 Connect the AC adapter and then turn off the display. Confirm that there is nothing on the weighing pan.

2 Press the **ON:OFF** key to turn on the balance.

When the balance displays **-E**, you must perform zero-point-calibration

3 Press the **RE-ZERO** key.

4 Press and hold the **RE-ZERO** key until the balance displays **CAL**. Then release the **RE-ZERO** key. The balance enters calibration mode.

5 Press the **RE-ZERO** key. The balance measures zero point.

Make sure that the balance stability is not influenced by breeze or vibration.

6 Press the **RE-ZERO** key.

The zero-point-calibration is finished and the balance returns to the normal weighing mode.

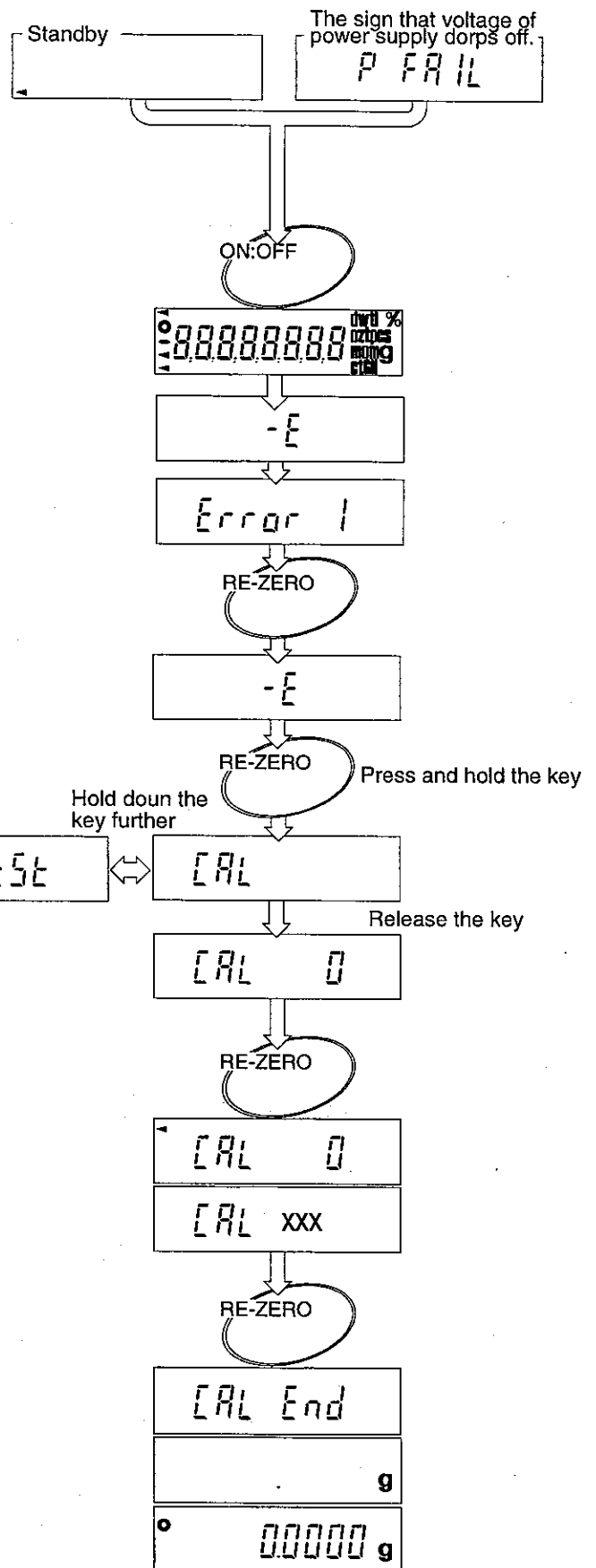



Functions



Your HR series has a number of internal software parameters that enable you to select the best weighing features for your needs. These settings control how you want the balance to respond to its environment, various commands, operations and options. An overall parameters table is shown below.

All of the parameters have initial settings from the factory, or possibly from your dealer. You may easily change these settings as you need them, or conditions vary.

These settings are stored in the balance until the next change even without power applied. The section, C-parameters keys and displays, explains how to change the parameter. The individual settings for each group are detailed in C-parameters settings.

Group Number	Item and Item Number							
	Group	0	1	2	3	4	5	6
0	[C-0] Environment	Stb-b Stability band	Cond Resp. / Environ.	trc Zero tracking				
1	[C-1] Display update	SPEED Refresh rate	Point Decimal point	P-on Auto start function	rANGE Minimum display			
2	[C-2] Auto re-zero	Ar-0 Auto re-zero on/off	Ar-b Auto re-zero band	Ar-t Detection time	Some products can not select this function			
3	[C-3] Calibration	CAL Calibration inhibit						
4	[C-4] Data out	Pr int Data out mode	AP-P Auto print polarity	AP-b Auto print band	PAUSE Data pause	At-F Auto feed	Ar-d Zero after data out	info Cal verification
5	[C-5] Serial interface	bPS Baud rate	bt-Pr Length, Parity bit	Cr-LF Terminator	TYPE Data format	t-UP Receive time	E-Cod Error code	CTS CTS control
6	[C-6]	Response/environment is common data with the condition of response accessible using the keyboard. If a value is set in the C parameters, it will be changed if new conditions of response are set.						
7	[C-7] Analog out							
8	[C-8]							
9	[C-9] Parameter control	Pn ID protect	PF Parameter protect					

- If you install serial interface OP-03, OP-05 or analog output in the balance, you can select and change the parameter **[C-4]** and **[C-5]**.



C-parameter keys and displays



This mark appears when a memorized parameter is displayed.



The **MODE** key is used to select the group of C-parameters.



The **RANGE** key is used to select the item from the group selected by the **MODE** key.

RE-ZERO

The **RE-ZERO** key is used to select a parameter for the item selected by the **MODE** and **RANGE** keys.

PRINT

The **PRINT** key is used to save the new C-parameter settings and to exit to the weighing mode.

ON:OFF

The **ON:OFF** key cancels the new C-parameter settings and turns the display off.

Internal parameter setting

1 Turn the display off.

2 Press and hold the **RE-ZERO** key and press the **ON:OFF** key. Release both keys.

3 Press the **MODE** key.
The balance displays the software version (x.xx), and then enters into the C-parameter settings.

4 Press the **MODE** key (several times), until the parameter "[-Z]" is displayed.

5 Press the **RANGE** key (several times), until the parameter "Ar-t" is displayed.

6 Press the **RE-ZERO** key (several times), until the parameter "Z" is displayed.

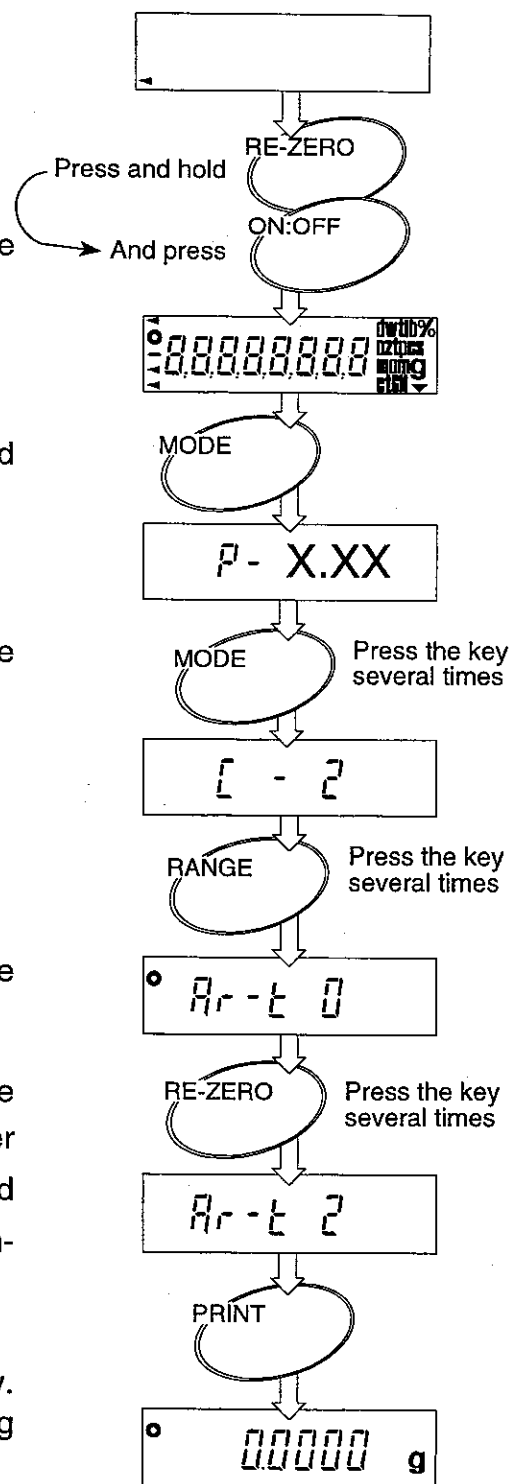

7 If you want to enter parameters for other items, use the following keys. **MODE** key to select the parameter group. **RANGE** key to select the item of the selected parameter group. **RE-ZERO** key to select the parameter of the selected items.

8 Store the C-parameter set using the **PRINT** key. Then the balance will return to normal weighing mode.



C-Parameter Settings

[- 0] Environment: The settings adjust the balance to your environment.

		 The Stability indicator lights when the display fluctuation is within the range set below
Stb-b Stability band width	0	Stable when within ± 1 digit per second.
	*1	Stable when within ± 2 digits per second.
	2	Stable when within ± 3 digits per second.
[ond Response / Environment	0	<p>Better weighing conditions faster weighing response</p> <p style="text-align: center;"></p> <p style="text-align: center;">↓</p> <p>Worse weighing conditions slower weighing response</p>
	1	
	*2	
	3	
	4	
trc Zero tracking	0	Zero tracking off
	1	<p>Weak zero tracking</p> <p style="text-align: center;">↓</p> <p>Strong zero tracking</p> <p>The balance tracks zero-drift caused by change of temperature, humidity, air pressure, etc., and stabilizes the ZERO point. Display continues to ZERO if the drift is less than 1 digit per average. If weighing very light samples, select a lower number (weak tracking).</p>
	*2	
	3	
	4	



* factory setting

[- 1] Display Update, Decimal Point and Auto Start

SPEED Display update rate	*0	Display is refreshed at normal speed. (5 times per seconds)	
	1	Display is refreshed at high speed. (10 times per seconds)	
Point Decimal point display	*0	Point (.)	
	1	Comma (,)	
P-on Auto start function	*0	No auto start	Choose whether the display is to come on automatically without using the ON:OFF key when power is supplied.
	1	Auto start	
r-RANGE Minimum figure	parameter	The setting to display the minimum figure when you start weighing. The minimum figure can be turned on/off by pressing the RANGE key alternately. Caution • This function can not be used in the counting or percent modes. • Some products can not select this function.	
	*0	The minimum figure is displayed when the balance is first turned on.	
	1	The minimum figure is not displayed when the balance is first turned on.	

* factory setting

[- 2] Auto Re-ZERO Function

<i>Ar - 0</i> Auto Re-Zero function when near Zero	*0	Auto Re-ZERO off	
	1	Auto Re-ZERO on	•Auto Re-ZERO occurs when display is ±'Ar-b' digits for the time 'Ar-t'
<i>Ar - b</i> Auto re-zero band	*0	Zero when within ±5 digits of the zero-point.	slow Re-ZERO
	1	Zero when within ±50 digits of the zero-point.	
	2	Zero when within ±500 digits of the zero-point.	
<i>Ar - t</i> Time for auto zero determination	*0	Re-ZERO when near zero for more than a half second.	fast Re-ZERO
	1	Re-ZERO when near zero for more than 1 second.	
	2	Re-ZERO when near zero for more than 2 seconds.	
	3	Re-ZERO when near zero for more than 4 seconds.	
		slow Re-ZERO	

* factory setting

[- 3] Keys that can be used for calibration.

<i>CAL</i> Calibration keys accepted	0	Keyboard and EXT. switch can not be used.
	1	Keyboard can be used, EXT. switch can not be used.
	*2	Keyboard and EXT. switch can be used.

* factory setting

[- 4, [- 5, [- 7: refer to the instructions for these separately available options.

[- 6, [- 8: Are not used.

[- 9

C-parameter control

<i>Pn</i> ID protect	parameter	Parameter definition and use. Determines whether a change is permitted to the ID number
	*0	Permits a change to the ID number
	1	Inhibits a change to the ID number
<i>Pf</i> Parameter protect	parameter	Parameter definition and use.
	*0	Permits a change to the C-parameters.
	1	Inhibits a change to the C-parameters.
	2	C-parameters are returned to the factory settings.

* factory setting



Miscellaneous



Digital Tare

Setting Digital Tare



Instead of placing a container on the balance and pressing the **RE-ZERO** key, you can enter the weight of the container via this Digital Tare. The Digital Tare range is from zero to maximum capacity.



If you press the **RE-ZERO** key after setting the Digital Tare, the balance will store the value of the weight on the pan into **Pt**.

- 1** Turn the display on.
- 2** Press and hold the **RANGE** key until the balance displays **Pt**. (Preset Tare)
- 3** Press the **RE-ZERO** key. The value of digital tare will be displayed. If you want to change the value, press the **MODE** key.
- 4** Set the digital tare that you want using following keys.

MODE

The **MODE** key is used to select the figure to be changed.

RE-ZERO

The **RE-ZERO** key is used to change the number that is displayed.

PRINT

The **PRINT** key saves the new Digital Tare value and returns to the weighing mode.

ON:OFF

The **ON:OFF** key turns the display off without saving the new Digital Tare.

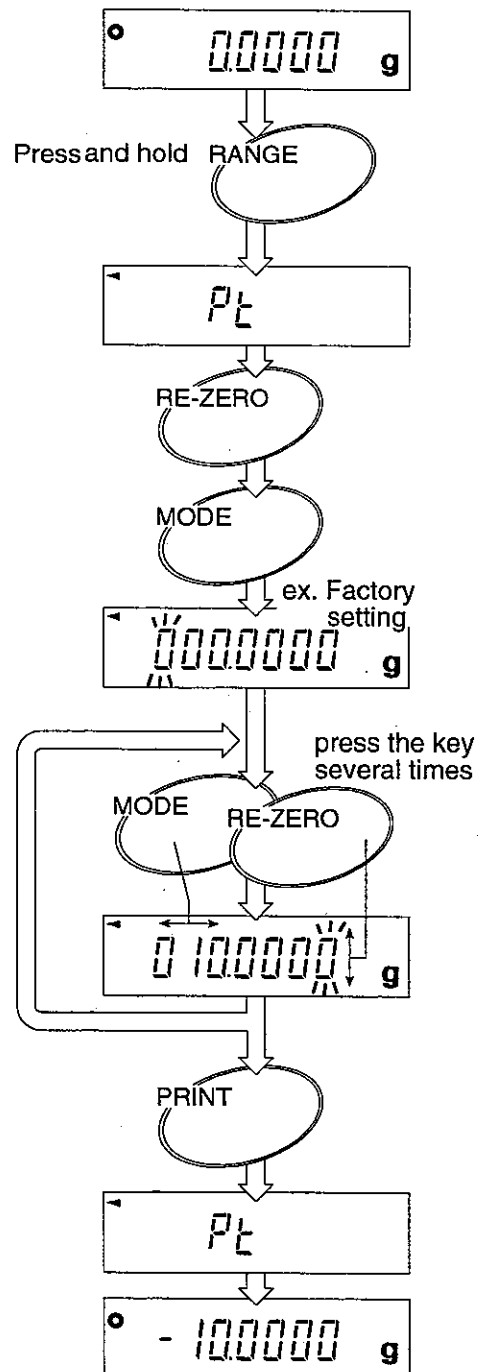

The ID number

- The ID number is used to identify the balance when using Good Laboratory Practice (GLP).
- Option 03 or 05 is necessary to output the balance data using the ID number.
- The data can be transmitted to an AD-8121 printer or a computer using option 03 or 05.
- Verifying the calibration executes using the ID number and weighing data after the calibration. The AD-8121 printer will add the date and time.

Setting the ID number

The ID number is saved in the balance memory without the AC adapter or optional battery connected and is effective until the next change. The ID number for HR-60 / 120 / 200 is seven figures. The ID number for HR-202 / 300 is eight figures.

 If you do not complete steps 2 and 3 within five seconds, the balance returns to the weighing mode without saving the new ID number.

- 1** Set the parameter $[-g, P_n]$ to permit a change of ID number. Turn the display off.
- 2** Press and hold the **RANGE** key and press the **ON:OFF** key.
- 3** Press the **MODE** key. The ID number will blink.
- 4** Set your ID number using following keys.
HR-60 / 120 / 200 is seven figures.
HR-202 / 300 is eight figures.

 The **RANGE** key switches between numbers and characters.

 The **RE-ZERO** key is used to change the character that is displayed. You can select following characters.
0-9, -, (space mark), and A-Z.
Refer to the 'Display Character Set' on the next page.

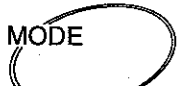
 The **MODE** key is used to shift the character that is displayed.

- 4** Press the **PRINT** key to save the new ID number and return to the weighing mode.

If you do not want to enter a new ID number, press the **ON:OFF** key. This turns the display off without saving the new ID number.

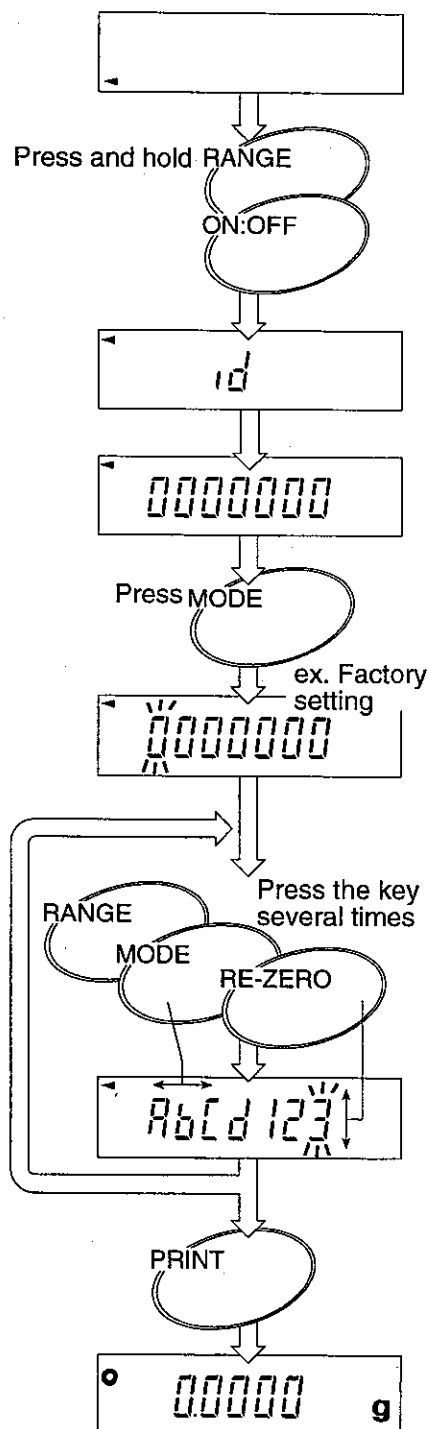

Display Character Set:

A	B	C	D	E	F	G	H	I	J	K	L	M	N	O	P	Q	R	S	T	U	V	W	X	Y	Z
a	b	c	d	e	f	g	h	i	j	k	l	m	n	o	p	q	r	s	t	u	v	w	x	y	z
1	2	3	4	5	6	7	8	9	0	-	_(Space)														
1	2	3	4	5	6	7	8	9	0	-															

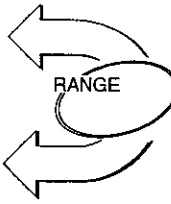

External key connector

An external key plug is available, to enable remote control of the balance. When this plug is connected to the external key jack, RE-ZERO and PRINT instructions can be sent to the balance. Refer to the diagram below. You must short the GND line to the PRINT or RE-ZERO line for at least 100ms.

In the following example, the Print switch is turned on.

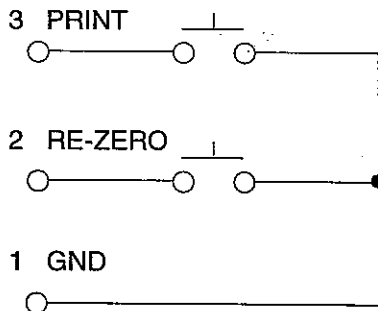
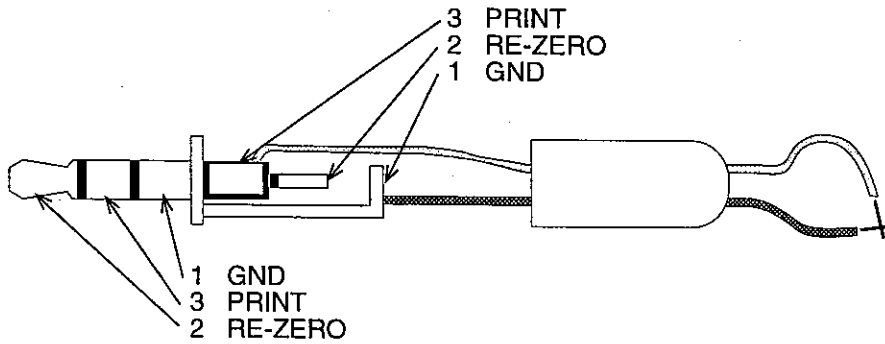

The external key plug is sold separately as an optional item.
Part name: AX-T-314A-S

Underhook Weighing

The HR series balances are equipped with a standard built-in underhook. This makes density determination a relatively simple matter. Also use the underhook to weigh magnetic material.

- 1** You can find the underhook behind the plastic plug on the under-side of your balance.
- 2** Place the balance on a weighing table with a hole cut in it or place it on a firm metal stand designed for underhook weighing.
- 3** Hang a light-weight weighing harness from the underhook, or thread a strand of thin string /wire through it.
- 4** For best results recalibrate the balance with the harness in place.

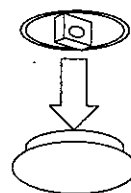
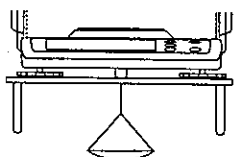

An Example of Underhook Weighing

- 1** Press the **RE-ZERO** key to zero the display.
- 2** Place the material on the pan.
Find the weight *A* of the material in air. $A = 10.0000\text{g}$
- 3** Press the **RE-ZERO** key.
- 4** Lower the material into water at 10°C .
Find the weight *B* of the material in water. $B = 0.4666\text{g}$
- 5** Find a water density *C* from following table. $C = 0.99970\text{g/cm}^3$

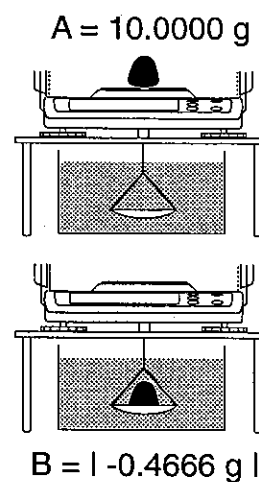

0°	0.99984 g/cm ³	
4	0.99997	
10	0.99970	
15	0.99910	
20	0.99820	
25	0.99704	
30	0.99565	Reference

$$\text{Volume} = \frac{0.4666 \text{ g}}{0.99970 \text{ g/cm}^3} = 0.4667 \text{ cm}^3$$

$$\text{Density} = \frac{10.0000 \text{ g}}{0.4667 \text{ cm}^3} = 21.4 \text{ cm}^3$$

- 6** The density is 21.4 g/cm^3 . This material is most likely platinum.



Errors

Over load Error

E

This display indicates that the weight placed on the pan is beyond the balance capacity.

Weighing pan Error

-E

This display indicates that the weighing pan or the pan support are not properly installed.

Power failure Error

P FAIL

This display indicates that power was interrupted during weighing the last time the balance was used. Press the **ON:OFF** key to clear.

Stability Error

Error 1

This display indicates that the balance can not become stable while zeroing or weighing. Check for excessive vibration or drafts. Press the **RE-ZERO** key to clear.

Digital Input Error

Error 2

This display indicates that unacceptable Digital data was input.

Zero-point Error

This display indicates that the zero-point of weighing has shifted from last calibrating zero-point, make certain that there is nothing on the weighing pan. Execute calibration to reset the zero-point.

CAL Errors

CAL E

This display indicates that the calibration mass is too heavy.

-CAL E

This display indicates that the calibration mass is too light.

Sample weight Error

Lo

The sample weight is very light. The balance can not calculate the unit weight or 100% weight.

Sample quantity Notice

XX -

If samples are lighter than the correct value, counting error becomes too large and the balance asks to place the required number of samples. Count and place the requested samples on the pan. Press the **RANGE** key to store the correct value.

xx = 20, 30, 40, 50, 60, 70, 80, 90, 100

Error 0

Error 3

Error 4

Error 8

Error 9

The balance needs repair. Request service from the store where you purchased the balance, or from the A&D service group.



Specifications



Specifications

MODEL	HR-300	HR-202	HR-200	HR-120	HR-60
Weighing capacity g	310	210 / 42	210	120	60
Minimum weighing display g	0.1	0.1 / 0.01	0.1		
Minimum 100% weighing mg	10.0				
Minimum unit weighing mg	0.1				
Repeatability (Standard deviation) mg	0.2	0.1 / 0.02	0.1		
Linearity mg	± 0.3	± 0.2 / 0.03	± 0.2		
Sensitivity drift ppm/°C	± 2 (10°C ~ 30°C)				
Stabilization time sec.	3.5 (typical)	3.5 / 8 (typical)	2.5 (typical)		
Display Update Rate	5 times / second , 10 times / second				
Weighing Pan mm	φ 90	φ 80	φ 85		
Calibration Mass g				50	50
			100	100	100
	200	200	200		
	300				
Net weight kg	8.0		5.8		
Operating condition	5°C ~ 40°C, RH < 85%, Do not allow condensation to form				
Power consumption	AC adaptor, 11VA approximately				



External Dimensions

HR-200 / 120 / 60

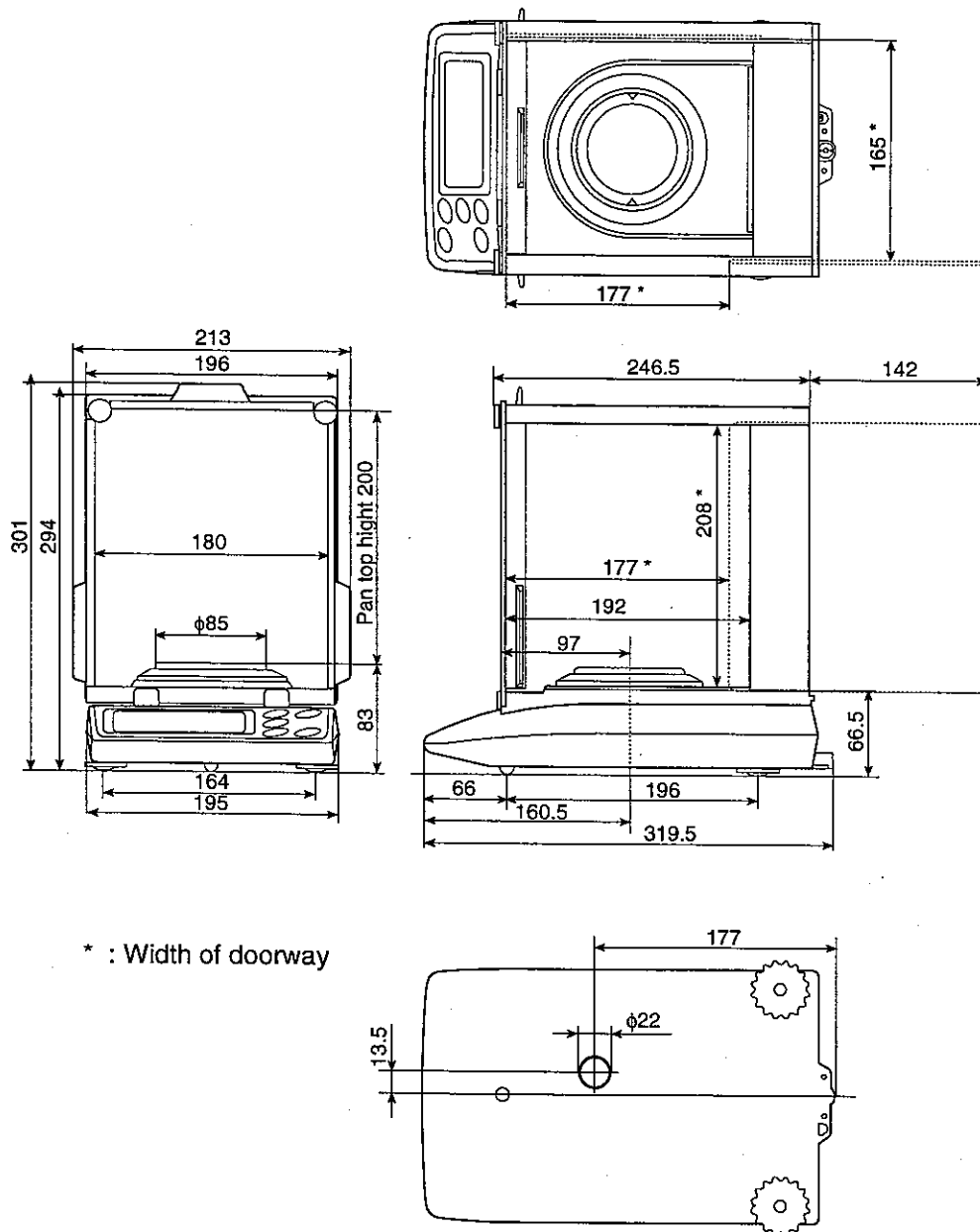

HR-202 / 300

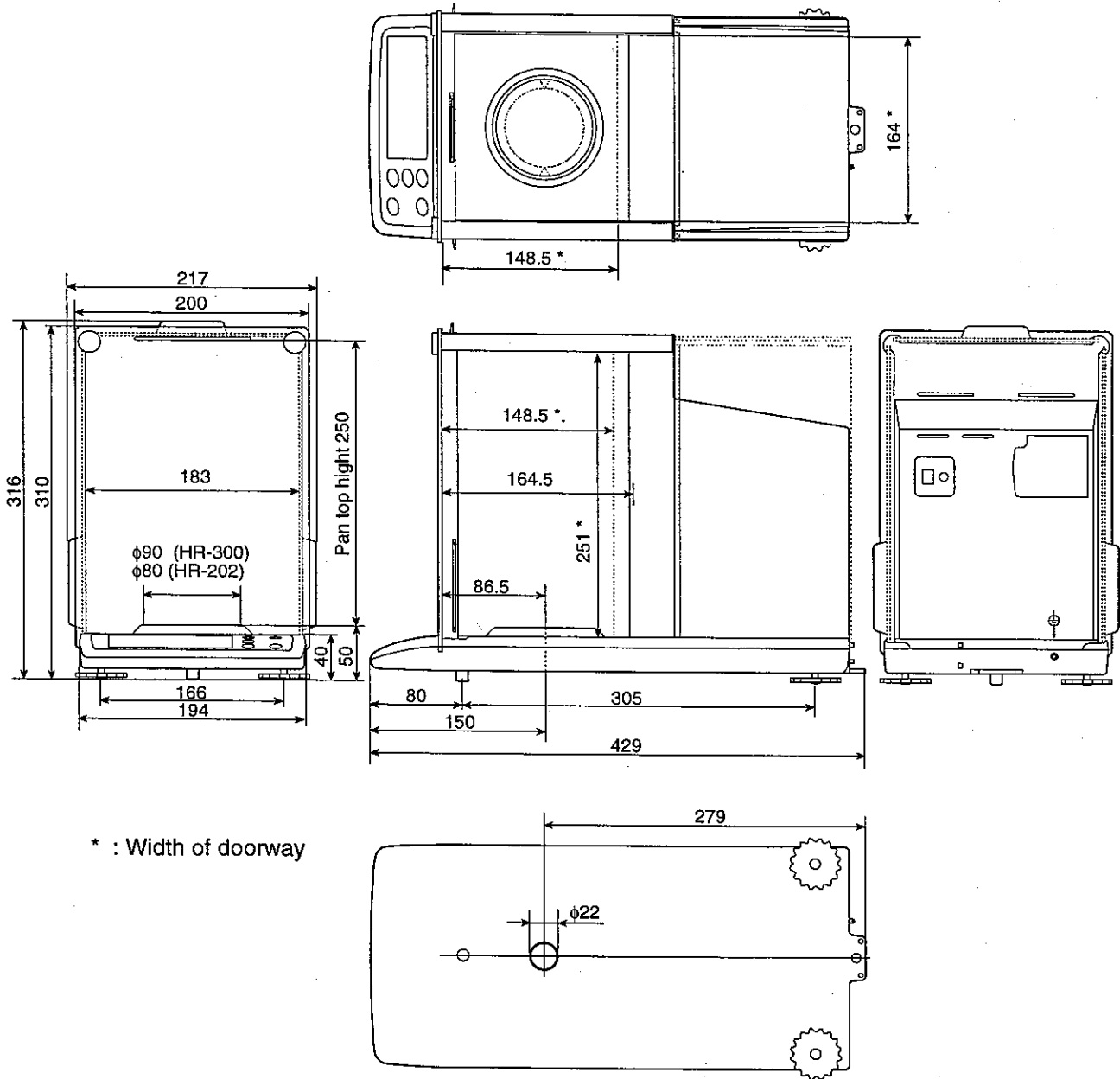

* : Width of doorway



Index

Symbols

-----	22,23,32
.....	16,18
100% weight	18

A

AC adapter	7
ACAI	14,15
AD-8121A	3,29
<i>AP - b</i>	24
<i>AP - P</i>	24
<i>Ar - 0</i>	24,27
<i>Ar - b</i>	24,27
<i>Ar - d</i>	24
<i>Ar - t</i>	24,25,27
<i>At - F</i>	24

B

<i>bPS</i>	24
<i>bE - Pr</i>	24

C

<i>[- 0</i>	24,26
<i>[- 1</i>	24,26
<i>[- 2</i>	24,25,27
<i>[- 3</i>	21,22,24,27
<i>[- 4</i>	20,21,22,24
<i>[- 5</i>	24
<i>[- 6</i>	24
<i>[- 9</i>	24,27,29
<i>[AL</i>	20,21,22,23,24,27
<i>[AL E</i>	20,32
<i>-[AL E</i>	20,32
Calibration mass	20,34
Capacity	34
<i>[[</i>	20
<i>[ond</i>	19,24,26
<i>[r - LF</i>	24
<i>[tS</i>	24
Current Loop	3

E

<i>E</i>	32
<i>-E</i>	22,23,32
<i>E - Load</i>	24
<i>Error 1</i>	20,23,32
<i>Error 2</i>	32
<i>Error 3489</i>	33

F

Functions	24
-----------	----

G

GLP	3,20,29
Grain	9

I

ID	29
<i>id</i>	29
interface	3
<i>infid</i>	20,21,22,24

K

key	8
-----	---

L

Linearity	34
<i>Lo</i>	13,32

M

Messghal	9
Metric Carat	9
momme	9

O

OP-03	3,4
OP-05	4
Ounce	9

P

<i>PAUSE</i>	24
<i>P-on</i>	24,26
pcs	9,12
Pennyweight	9

<i>PF</i> -----	24,27
<i>P FAIL</i> -----	7,23,32
<i>Pn</i> -----	24,27,29
<i>Po int</i> -----	24,26
<i>Pr int</i> -----	24
<i>Pt</i> -----	16,18,28

R

<i>r RANGE</i> -----	24,26
Repeatability -----	34
RS-232C -----	3

S

<i>SPEED</i> -----	24,26
stabilization mark -----	8
Stand-by Indicator -----	8
<i>Set b-b</i> -----	24,26

T

Tael -----	9
Tola -----	9
<i>Trc</i> -----	24,26
Troy Ounce -----	9
<i>t-UP</i> -----	24
<i>TYPE</i> -----	24

U

<i>Unit</i> -----	10
<i>U₂</i> -----	16,18

Z

zero-point -----	21,22,23
------------------	----------