



TA INSTRUMENTS



Thermal Analysis



LOCAL OFFICES

- New Castle, DE USA +1-302-427-4000
- Lindon, UT USA +1-801-763-1500
- Hialeah, FL USA +1-305-828-4700
- Crawley, United Kingdom +44-1293-658900
- Shanghai, China +86-21-64956999
- Taipei, Taiwan +88-62-25638880
- Tokyo, Japan +81-3-5759-8500
- Seoul, Korea +82-2-3415-1500
- Bangalore, India +91-80-2319-4177-79
- Paris, France +33-1-30-48-94-60
- Eschborn, Germany +49-6196-400-600
- Brussels, Belgium +32-2-706-0080
- Eetten-Leur, Netherlands +31-76-508-7270
- Sollentuna, Sweden +46-8-555-11-521
- Milano, Italy +39-02-265-0983
- Barcelona, Spain +34-93-600-93-32
- Melbourne, Australia +61-3-9553-0813
- Mexico City, Mexico +52-55-52-00-18-60

DIFFERENTIAL SCANNING CALORIMETRY

Q2000	3
Q200	5
Q20	7
DSC Technology	9
Accessories	11
Temperature Control Options	17
Tzero® Technology	21
MDSC® Technology	25
Applications	27

THERMOGRAVIMETRIC ANALYSIS

Q5000IR	35
Q500	37
Q50	39
Q5000IR Technology	41
Q500 / Q50 Technology	47
TGA Accessories & Options	49
Applications	55

SIMULTANEOUS DSC/TGA

Q600	67
SDT Technology	69
Applications	71

VAPOR SORPTION ANALYSIS

VTI-SA	75
VTI-SA Technology	77
VTI-SA3 Sorption Analyzer	82
Q5000SA	83
Q5000SA Technology	87
Applications	91

DYNAMIC MECHANICAL ANALYSIS

Q800	97
Deformation Modes & Sample Size	99
Modes of Operation	100
Q800 Technology	101
Modes of Deformation	103
Accessories	105
DMA Theory	106
Applications	107

THERMOMECHANICAL ANALYSIS

Q400EM / Q400	113
Q400 Technology	115
Modes of Deformation	117
TMA Theory / Modes of Operation	119
Applications	123



DSC

Q2000 · Q200 · Q20



Q2000



The Q2000 is the industry's top-of-the-line, research-grade DSC, with unmatched performance in baseline flatness, precision, sensitivity, and resolution. Advanced Tzero® and Modulated DSC® technologies, a reliable 50-position autosampler, and multiple new hardware and software features make the Q2000 the most powerful, flexible, and easy-to-use DSC. A high-value new feature is Platinum™ software, which permits automatic scheduling of tests at off-work periods, designed to keep the Q2000 consistently in top operating condition. Available accessories, such as a new photocalorimeter, pressure DSC, and the widest array of cooling devices, make the Q2000 the DSC best equipped to satisfy the most demanding researcher.

TECHNICAL SPECIFICATIONS

TECHNOLOGIES

Tzero® Technology	Advanced
MDSC®	Advanced
Direct Cp Measurement	Included
Platinum™ Software	Included

HARDWARE FEATURES

SVGA Touch Screen	Included
User Replaceable Tzero Cell	Yes
50-Position Autosampler	Included
Autolid	Included
Dual Digital Mass Flow Controllers	Included
Full Range of Cooling Accessories (LNCS, RCS90, RCS40, CCS, FACS, QCA)	Available
Pressure DSC	Available
Photocalorimeter	Available

PERFORMANCE

Temperature Range	Ambient to 725 °C
With Cooling Accessories	-180 to 725 °C
Temperature Accuracy	+/- 0.1 °C
Temperature Precision	+/- 0.01 °C
Calorimetric Reproducibility (indium metal)	+/- 0.05 %
Calorimetric Precision (indium metal)	+/- 0.05 %
Dynamic Measurement Range	>+/- 500 mW
Baseline Curvature (Tzero; -50 to 300 °C)	10 µW
Baseline Reproducibility with Tzero	+/- 10 µW
Sensitivity	0.2 µW
Indium Height / Width (mW/°C)*	60

*Indium height/width ratio: 1.0 mg In heated at 10 °C/min in N₂ atmosphere. (A larger number denotes better performance).

Q200



The Q200 is a versatile, research-grade DSC with our patented Tzero® technology. With many Q200 performance features, the Q200 easily outperforms competitive research models. It is an expandable base module, to which MDSC®, a 50-position autosampler, a photocalorimeter accessory, and multiple cooling devices can be added. With its innovative technology, performance, upgradeability, and ease-of-use, the Q200 makes a great addition to any laboratory.

TECHNICAL SPECIFICATIONS

TECHNOLOGIES

Tzero® Technology	Basic
MDSC®	Optional
Platinum™ Software	Included

HARDWARE FEATURES

SVGA Touch Screen	Included
Tzero Cell (fixed position)	Included
50-Position Autosampler	Available
Autolid	Included
Dual Digital Mass Flow Controllers	Included
Full Range of Cooling Accessories (LNCS, RCS90, RCS40, CCS, FACS, QCA)	Available
Photocalorimeter	Available

PERFORMANCE

Temperature Range	Ambient to 725 °C
With Cooling Accessories	-180 to 725 °C
Temperature Accuracy	+/- 0.1 °C
Temperature Precision	+/- 0.05 °C
Calorimetric Reproducibility (indium metal)	+/- 0.1 %
Calorimetric Precision (indium metal)	+/- 0.1 %
Dynamic Measurement Range	>+/- 500 mW
Baseline Curvature (Tzero; -50 to 300 °C)	10 µW
Baseline Reproducibility with Tzero	+/- 10 µW
Sensitivity	0.2 µW
Indium Height / Width (mW/°C)*	30

*Indium height/width ratio: 1.0 mg In heated at 10 °C/min in N₂ atmosphere. (A larger number denotes better performance).

Q20



The Q20 Series (Q20, AQ20, Q20P) are cost-effective, easy-to-use, general-purpose DSC modules, with calorimetric performance superior to many competitive research-grade models. These are entry-level instruments not based on performance, but on available options. The Q20 family is ideal for research, teaching, and quality control applications that require a rugged, reliable, basic DSC. The AQ20 is designed for unattended analysis of up to 50 samples in a sequential manner. The Q20 and AQ20 include dual digital mass flow controllers. The Q20P is designed for studies of pressure-sensitive materials, or samples that may volatilize on heating.

TECHNICAL SPECIFICATIONS

HARDWARE FEATURES	Q20	AQ20	Q20P
Tzero® Cell (fixed position)	Included	Included	—
User Replaceable Cell	—	—	Yes
50-Position Autosampler	—	Included	—
Autolid	—	Included	—
Dual Digital Mass Flow Controllers	Included	Included	—
Full Range of Cooling Accessories (LNCS, RCS90, RCS40, CCS, FACS, QCA)	Available	Available	QCA Only
Pressure DSC	—	—	Yes
Platinum Software	—	Included	—

PERFORMANCE

Temperature Range	Amb to 725 °C	Amb to 725 °C	Amb to 725 °C
With Cooling Accessories	-180 to 725 °C	-180 to 725 °C	-130 to 725 °C
Temperature Accuracy	+/- 0.1 °C	+/- 0.1 °C	+/- 0.1 °C
Temperature Precision	+/- 0.05 °C	+/- 0.05 °C	+/- 0.05 °C
Calorimetric Reproducibility (indium metal)	+/- 1 %	+/- 1 %	+/- 1 %
Calorimetric Precision (indium metal)	+/- 0.1 %	+/- 0.1 %	+/- 0.1 %
Dynamic Measurement Range	+/- 350 mW	+/- 350 mW	+/- 350 mW
Digital Resolution	>0.04µW	>0.04µW	>0.04µW
Baseline Curvature (-50 to 300 °C)	<0.15 mW	<0.15 mW	—
Baseline Reproducibility	< 0.04 mW	<0.04 mW	—
Sensitivity	1.0 µW	1.0 µW	1.0 µW
Indium Height / Width (mW/°C)*	8.0	8.0	—

*Indium height/width ratio: 1.0 mg In heated at 10 °C/min in N₂ atmosphere. (A larger number denotes better performance).

Q SERIES™ DSC TECHNOLOGY



TZERO® CELL DESIGN

The Tzero cell is designed for excellence in both heating and cooling. The heat flow sensor is machined for symmetry from a single piece of durable, thin wall, high response constantan and directly brazed to the silver heating block. Design benefits include faster signal response, the flattest most reproducible baselines, superior sensitivity and resolution, improved data precision, and unmatched ruggedness.

A chromel/constantan Tzero thermocouple is located symmetrically between the sample and reference sensor platforms, and acts as an independent measurement and furnace control sensor. Matched chromel area thermocouples are welded to the underside of each sensor platform, providing independently measured sample and reference heat flows that result in superior DSC and MDSC® results.

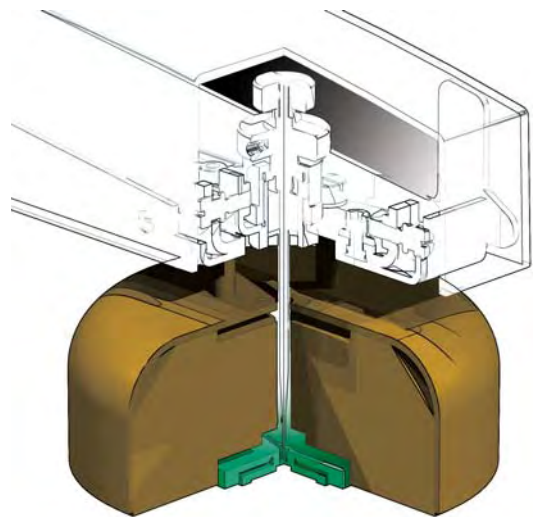

AUTO LID II

The Q2000, Q200, and AQ20 have a new and improved auto lid assembly that consists of dual silver lids, an innovative lifting/venting mechanism, and a dome-shaped heat shield. More accurate and reproducible measurements result from improved thermal isolation of the cell.

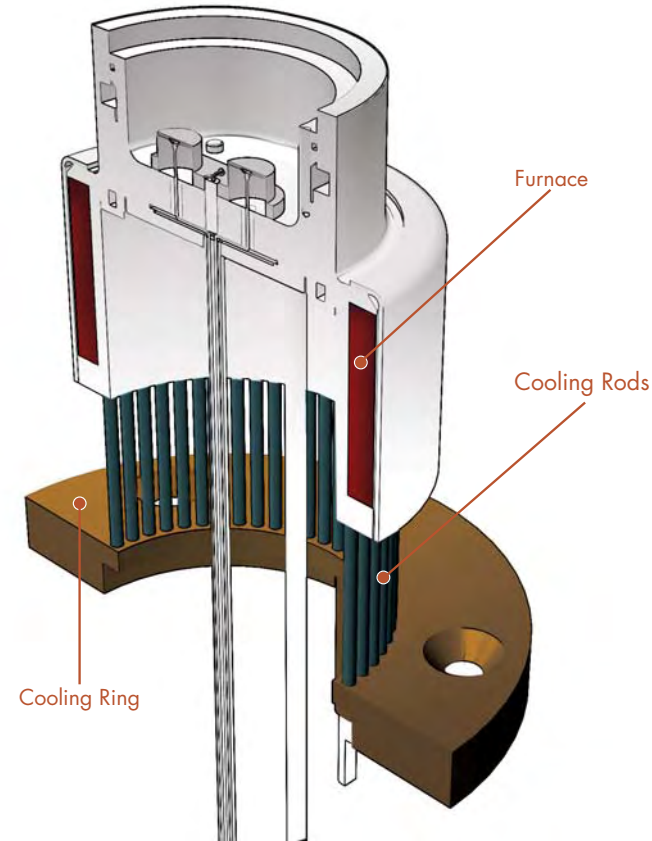

COOLING RODS & RING

The unique design features an array of nickel cooling rods that connect the silver furnace with the cooling ring. This design produces superior cooling performance over a wide temperature range, higher cooling rates and better agility from heating to cooling operation. Lower sub-ambient temperatures and faster turnaround time can be obtained with our expanded range of cooling accessories in isothermal, programmed or ballistic cooling, and MDSC® experiments.

FURNACE

The Tzero® transducer is enclosed in a high thermal conductivity, silver furnace, which uses rugged, long-life Platine!™ windings. Purge gases are accurately and precisely metered by digital mass flow controllers, and preheated prior to introduction to the sample chamber. Long furnace life and a highly uniform environment at the sample and reference sensors are ensured, as well as accurate isothermal temperatures, true linear heating rates, rapid temperature response and the ability to heat at rates up to 200 °C / min.

Platine!™ is a trademark of Englehard Industries

Q SERIES™ ACCESSORIES

AUTOSAMPLER

The patented* DSC autosampler is a powerful performance and productivity enhancer for the Q Series DSC modules. It provides reliable, unattended operation of the Q2000, auto Q200 and AQ20 modules. Unique in its ability to exchange up to 5 reference pans as well as 50 sample pans, the Q Series autosampler enables laboratories to reliably analyze samples "around-the-clock" in sequential order. An optical sensor guides the sample arm, ensuring precise pan placement and automatic calibration of the system. Maximum productivity from the DSC autosampler is achieved when paired with our intelligent Advantage™ software that permits pre-programmed analysis, comparison, and presentation of results.

*U.S. Patent No. 6,644,136; 6,652,015; 6,760,679; 6,823,278

PLATINUM™ SOFTWARE

To further assure high-quality data, Q Series DSC modules equipped with the DSC autosampler (Q2000, AQ200, AQ20) can take full advantage of the Platinum features inherent in our Advantage software. These permit a user to automatically schedule a variety of calibration, verification and diagnostic tests to ensure that the DSC is constantly kept in optimum operating condition. Platinum software allows all Q Series DSC instruments to provide email notification of the completion of an analysis. Also included is the ability to view and download any new software versions that TA Instruments develops as upgrades to its standard Advantage software.



TZERO® DSC SAMPLE ENCAPSULATION PRESS

A key contributor to the quality of DSC results is the sample preparation. The new Tzero press takes sample encapsulation to a higher level of performance and convenience in crimp and hermetic sealing of a wide variety of materials. The press kit includes die sets (4) for the new Tzero aluminum and Tzero hermetic pans & lids and also for our upgraded standard and hermetic pans & lids (optional die sets are available for hi-volume DSC pans and Q5000 TGA sealed pans). The die sets are magnetically attached with no tools or user adjustments required. In addition, each die set is color-coded to the box containing the compatible Tzero or standard aluminum or hermetic pans and lids.



TZERO® PANS / LIDS

DSC SAMPLE PANS/LIDS

TA Instruments offers a wide selection of sample pans to meet standard and specialized applications. Substantial engineering has advanced the quality and performance of our standard pans and lids, and resulted in the development of the new Tzero Series of high performance pans and lids. A key element in the industry leading performance of the Q2000 series DSC is the new Tzero press and Tzero pan / lid technology, which deliver unmatched data quality in important DSC measurements requiring sensitivity, resolution, enthalpy and temperature precision.

Fabricated using advanced technology and to extremely tight tooling specifications, the Tzero pans offer a significant improvement over previous generations, as well as competitors' technology, in standard performance tests on indium metal. Below note the improvement in signal response and peak quality when using the Tzero pan versus a standard pan.

The utility of the Tzero hermetic pan is shown below. In this example, DSC results for casein are shown using both a hermetic pan and a standard pan. Casein contains a significant amount of adsorbed moisture, which is evolved when heating in a standard pan. The resultant data only exhibits the large evaporation endotherm. However, when analyzed in a Tzero hermetic pan, the volatilization is suppressed, and the glass transition of the casein is clearly identified.

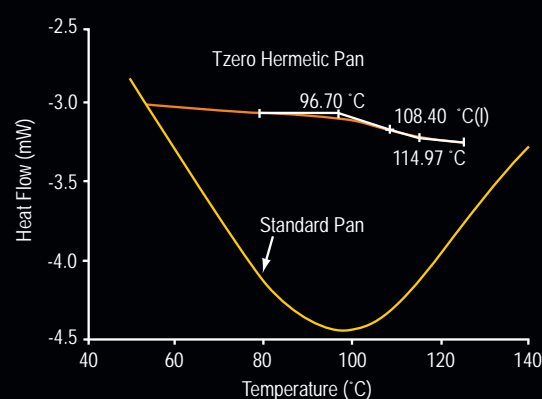
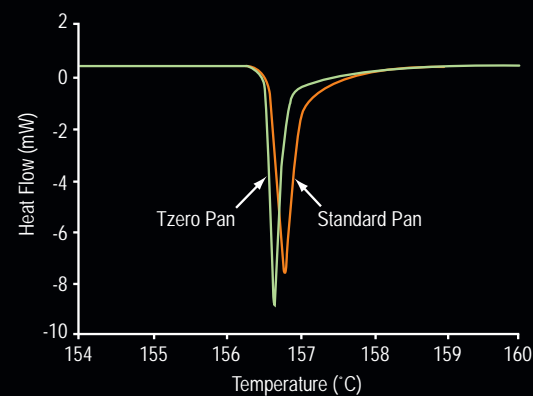

STANDARD PANS / LIDS

Further to TA Instruments' commitment to continuous quality improvement in DSC pan & lid technology, significant improvements in our standard aluminum crimped pans have also been realized. The result is a significant improvement in standard performance tests on indium metal. Note the improved sharpness of the melting peak, indicative of faster response and better resolution performance.

DSC pans & lids are available in aluminum, alodine-coated aluminum, gold, platinum, graphite and stainless steel versions. They can be used under a variety of temperature and pressure conditions. Samples can be run in the standard DSC mode in open pans, crimped or hermetically sealed pans / lids or in pressure capsules. Samples in open pans can also be run at controlled pressures using the PDSC Cell. All aluminum standard pans have the same temperature and pressure rating. General details of the pans are as follows:

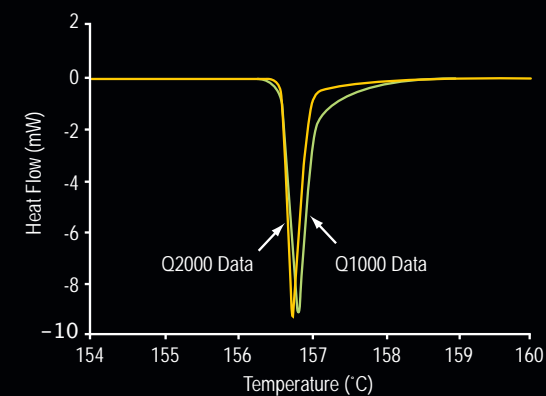

STANDARD	Temperature (°C)	Pressure
Aluminum	-180 to 600	100 kPa
Platinum	-180 to 725	100 kPa
Gold	-180 to 725	100 kPa
Graphite	-180 to 725	100 kPa

HERMETIC	Temperature (°C)	Pressure
Aluminum	-180 to 600	300 kPa
Alodined Aluminum	-180 to 600	300 kPa
Gold	-180 to 725	600 kPa
High Volume	-100 to 250	3.7 MPa
Pressure	Amb. to 250	10 MPa

PRESSURE DSC

The Q20P is a dedicated pressure DSC system that provides heat flow measurements on pressure sensitive materials from -130 to 725 °C, at pressures from 1 Pa (0.01 torr) to 7 MPa (1,000 psi). The pressure cell employs standard heat flux DSC technology and incorporates pressure control valves, a pressure gauge, and over-pressure protection. This pressure DSC cell is also an accessory for the Q2000 DSC and can be used as a standard (ambient pressure) cell from -180 to 725 °C.



MASS FLOW CONTROLLERS

High quality DSC experiments require precise purge gas flow rates. Mass flow controllers, along with integrated gas switching, provide flexible control as part of individual methods. Purge gas flow rates are settable from 0-240 mL/min in increments of 1 mL/min. The system is precalibrated for helium, nitrogen, air and oxygen and suitable calibration factors may be entered for other gases.



TEMPERATURE CONTROL OPTIONS

REFRIGERATED COOLING SYSTEMS (RCS90 AND RCS40)

The RCS is frequently selected as the preferred cooling device by thermal analysts for trouble-free, unattended DSC and MDSC® operation over a broad temperature range. Because it is a sealed system requiring only electrical power, the RCS has advantages for operation in areas where other refrigerants are difficult or expensive to obtain. TA Instruments offers two complementary models; the RCS90 and the RCS40. Both use the same cooling head, which fits snugly over the Q Series™ DSC Cell and completely eliminates frosting issues typical in competitive designs. Both controlled and ballistic cooling is achievable.

RCS90 Controlled Cooling Rates, from 550 °C (upper limit)*

CONTROLLED RATE	TO LOWER TEMPERATURE
100 °C/min	300 °C
50 °C/min	120 °C
20 °C/min	-20 °C
10 °C/min	-50 °C
5 °C/min	-75 °C
2 °C/min	-90 °C

* Performance may vary slightly, depending on laboratory conditions.

RCS90

The RCS90 employs a two-stage refrigeration system, which permits convenient DSC / MDSC operation over the temperature range from -90 °C to 550 °C. Typical RCS90 controlled cooling rates are detailed in the table above. Ballistic cooling from 500 °C to ambient is achieved in about 7 minutes. The RCS90 is compatible with all Q Series DSC Systems.



RCS40

The RCS40 employs a single-stage refrigeration system, which permits convenient DSC and MDSC® operation over the temperature range from -40 °C to 400 °C. Typical RCS40 controlled cooling rates are detailed in the table below. Ballistic cooling from 400 °C to ambient is achieved in about 7 minutes. The RCS40 is compatible with the Q2000, Q200, and Q20 models.



RCS40 Controlled Cooling Rates, from 400 °C (upper limit)*

CONTROLLED RATE	TO LOWER TEMPERATURE
65 °C/min	250 °C
50 °C/min	175 °C
20 °C/min	40 °C
10 °C/min	0 °C
5 °C/min	-15 °C
2 °C/min	-40 °C

* Performance may vary slightly, depending on laboratory conditions.

TEMPERATURE CONTROL OPTIONS

LIQUID NITROGEN COOLING SYSTEM

The Liquid Nitrogen Cooling System (LNCS) provides the highest performance and greatest flexibility in cooling. It has the lowest operational temperature (to $-180\text{ }^{\circ}\text{C}$), greatest cooling rate capacity (to $140\text{ }^{\circ}\text{C}/\text{min}$), and an upper temperature limit of $550\text{ }^{\circ}\text{C}$. Typical LNCS controlled cooling rates are detailed in the table below. Ballistic cooling from $550\text{ }^{\circ}\text{C}$ to ambient is achieved in about 5 minutes. Its autofill capability allows the LNCS to be automatically refilled from a larger liquid nitrogen source for continuous DSC operation. The LNCS is available for all Q Series™ DSC Systems (Except the Q20P).



LNCS Controlled Cooling Rates, from $550\text{ }^{\circ}\text{C}$ (upper limit)*

CONTROLLED RATE	TO LOWER TEMPERATURE
100 $^{\circ}\text{C}/\text{min}$	200 $^{\circ}\text{C}$
50 $^{\circ}\text{C}/\text{min}$	0 $^{\circ}\text{C}$
20 $^{\circ}\text{C}/\text{min}$	-100 $^{\circ}\text{C}$
10 $^{\circ}\text{C}/\text{min}$	-150 $^{\circ}\text{C}$
5 $^{\circ}\text{C}/\text{min}$	-165 $^{\circ}\text{C}$
2 $^{\circ}\text{C}/\text{min}$	-180 $^{\circ}\text{C}$

* Performance may vary slightly, depending on laboratory conditions.

FINNED AIR COOLING SYSTEM

The Finned Air Cooling System (FACS) is an innovative cooling accessory for all the Q Series™ DSC modules that offers a cost-effective alternative to the RCS or LNCS cooling systems. The FACS can be used for controlled cooling experiments, thermal cycling studies, and to improve sample turnaround time. Stable baselines and linear heating and cooling rates can be achieved between ambient and $725\text{ }^{\circ}\text{C}$.

CIRCULATOR COOLING SYSTEM (CCS)

The Circulator Cooling System (CCS) is a cost-effective cooling accessory for DSC modules and is adaptable to a variety of cooling media. It is also compatible with older modules when upgraded to the latest Q2xxx Series configuration. The CCS consists of an open-loop heat exchanger through which a condensed water-based fluid is circulated. TA Instruments optionally offers the PolyScience Model 612 Chiller / Circulator, which permits operation from 500 to $-5\text{ }^{\circ}\text{C}$. The CCS can be used in conjunction with any chiller / circulator or tap water with a circulation rate of at least 1 liter/min. The lower temperature limit is a function of the cooling media temperature and can be operated as low as $-15\text{ }^{\circ}\text{C}$.

QUENCH COOLING ACCESSORY

The Quench Cooling Accessory (QCA) is a manually operated cooling accessory, whose primary use is with the Q20 DSC to quench cool a sample to a sub-ambient temperature prior to heating to an upper limit. The recommended temperature of operation of the QCA is from -180 to $400\text{ }^{\circ}\text{C}$. The QCA reservoir is easily filled with ice water, liquid nitrogen, dry ice, or other cooling media.

TZERO® TECHNOLOGY PROVIDES:

- Flat reproducible baselines with better than an order of magnitude improvement on competitive designs, especially in the sub-ambient temperature range
- Superior sensitivity due to flatter baselines and better signal-to-noise ratio
- Best available resolution (better than power compensation devices)
- Faster MDSC® experiments
- Direct measurement of heat capacity (Q2000)

TZERO DSC TECHNOLOGY

Tzero technology represents a fundamentally more accurate system for measuring heat flow, by incorporating cell resistance and capacitance characteristics which were previously assumed to be negligible. The inclusion and compensation of these effects dramatically improves the baseline response and reproducibility. The heat flow resolution is also improved by directly measuring the heating rate difference between the sample and reference, and compensating for its effect on heat flow. This Tzero approach to measuring heat flow is a proprietary and patented* technology, only available on TA Instruments Q Series™ DSC instruments.

*U.S. Patent No. 6,431,747; 6,488,406; 6,523,998

$$q = -\frac{\Delta T}{R_r} + \Delta T_0 \left(\frac{1}{R_s} - \frac{1}{R_r} \right) + (C_r - C_s) \frac{dT_s}{dt} - C_r \frac{d\Delta T}{dt}$$

Principal
Heat
Flow

Thermal
Resistance
Imbalance

Thermal
Capacitance
Imbalance

Heating
Rate
Imbalance



TZERO® DSC PERFORMANCE

BASELINE STABILITY (FLATNESS)

The figure below shows a comparison of a Q2000 empty cell baseline with that from a heat traditional flux DSC. The data shows that the Q2000 baseline is superior in every way. The start-up offset is much smaller, the baseline is dramatically straighter, and the slope is greatly reduced. This contrasts markedly with results from other DSC designs, where a baseline curvature 1 mW over the same temperature range is often considered acceptable.

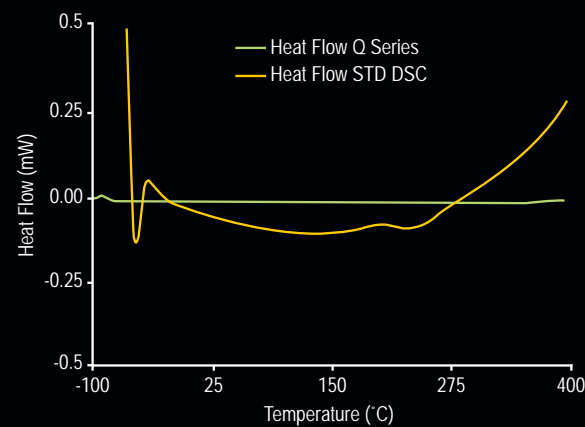

SENSITIVITY (POLYMER T_g)

Below shows a Q2000 high sensitivity glass transition (T_g) measurement, as a function of heating rate, for a very small (1 mg) sample of polypropylene, whose T_g is not easily measured by DSC due to its highly crystalline nature. The data shows that the T_g is easily detected even at a slow 5 °C/min heating rate. The excellent Q2000 baseline is the essential key for accurate measurements of glass transitions and heat capacity from materials that exhibit weak and broad transitions.

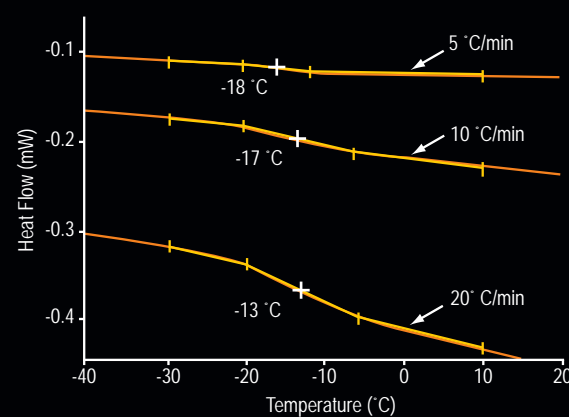

SENSITIVITY (LACTOSE T_g)

The figure illustrates this high level of sensitivity in a pharmaceutical application. The detection of small amounts of amorphous lactose is critical for drug development, and is easily achieved on a 10 mg sample at 20 °C/min using the Q2000. The direct measurement of heat capacity allows the step change in C_p to be quantified, which is found to be directly proportional to the amount of amorphous material present in the sample.

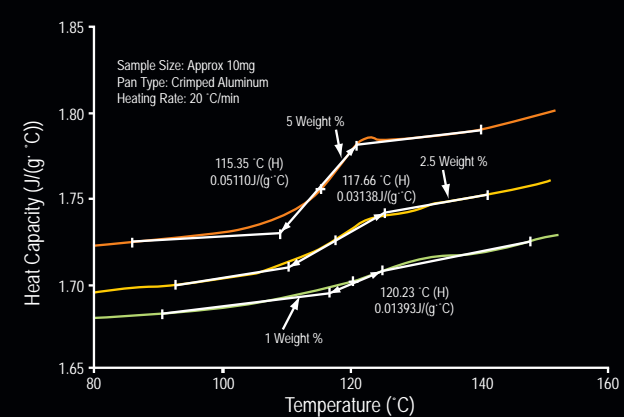

RESOLUTION

The figure below shows the excellent resolution inherent in the Tzero® heat flow signal. This pharmaceutical compound contains a series of polymorphic transitions. Note that each peak is easily resolved, while simultaneously maintaining sensitivity for the subtle glass transition at lower temperature (inset).

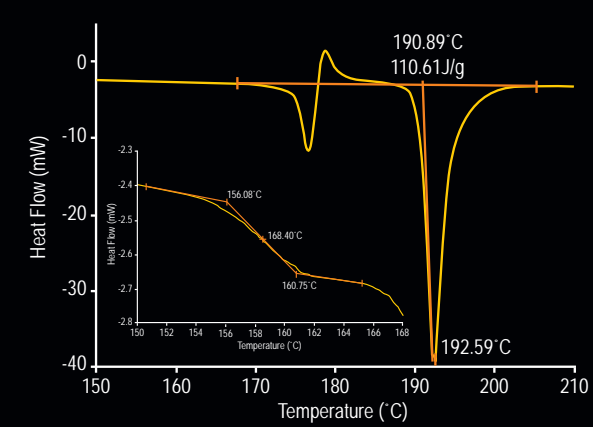

MDSC® TECHNOLOGY PROVIDES:

- Separation of complex transitions into more easily interpreted components
- Increased sensitivity for detecting weak transitions and melts
- Increased resolution without loss of sensitivity
- Direct measurement of heat capacity
- More accurate measurement of crystallinity

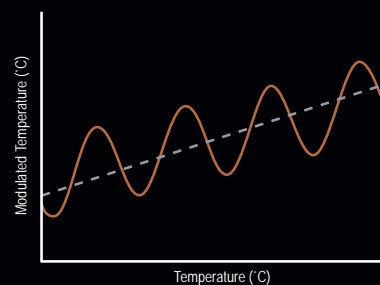

MODULATED DSC® TECHNOLOGY

In MDSC*, a sinusoidal temperature oscillation is overlaid on the traditional linear ramp. The net effect is that heat flow can be measured simultaneously with changes in heat capacity. In MDSC, the DSC heat flow is called the Total Heat Flow, the heat capacity component is the Reversing Heat Flow, and the kinetic component is the Nonreversing Heat Flow. The Total Heat Flow signal contains the sum of all thermal transitions, just as in standard DSC. The Reversing signal contains glass transition and melting transitions, while the Nonreversing Heat Flow contains kinetic events like curing, volatilization, melting, and decomposition. The Q2000 uniquely permits increased MDSC productivity of high quality data by its ability to operate at standard DSC heating rates (e.g., 10 °C / min.).

*U.S. Patent Nos. 5,224,775; 5,248,199; 5,346,306
Canadian Patent No. 2,089,225
Japanese Patent No. 2,966,691

$$\frac{dH}{dt} = C_p \frac{dT}{dt} + f(t, T)$$

$$\text{Heat Flow} = \text{Heat Capacity Component} + \text{Kinetic Component}$$

$$\text{Total Heat Flow} = \text{Reversing Heat Flow} + \text{Nonreversing Heat Flow}$$



MDSC® APPLICATIONS

SEPARATION OF COMPLEX TRANSITIONS

The figure below shows the MDSC results for a thermoplastic alloy blend of polycarbonate (PC) and polybutylene terephthalate (PBT). This material exhibits a variety of overlapping transitions, and interpretation of the Total Heat Flow is complicated. MDSC effectively separates the crystallization of the PBT component into the Nonreversing Heat Flow, thereby allowing for accurate determination of the glass transition temperatures of each polymer.

IMPROVED SIGNAL SENSITIVITY

MDSC provides improved sensitivity for measuring very broad and weak transitions, such as glass transitions in highly crystalline polymers or where the T_g is hidden beneath a second overlapping thermal event. This data was generated using a very small (2.2 mg) sample of a polymer coating. The total heat flow shows no transitions in the region where a T_g would be expected, though the large endotherm around 40 °C indicates solvent loss. The Reversing Heat Flow does indicate a very weak (8.5 μW) T_g around 109 °C, confirming the sensitivity of the MDSC technique.

IMPROVED DATA INTERPRETATION

The figure shows an application of interest in studies of foods or pharmaceuticals, in which the MDSC® total heat flow signal and its reversing and non-reversing components are displayed for a quenched 40% aqueous sucrose sample. The reversing signal clearly indicates a T_g for sucrose between -43.6 and -39.4 °C. The exothermic nonreversing signal relates to crystallization of free water that could not crystallize during quench cooling of the sample due to a significant increase in mobility and diffusion of the material at the glass transition.

QUASI-ISOTHERMAL HEAT CAPACITY

One of the major benefits of Modulated DSC® is the ability to measure heat capacity in a quasi-isothermal mode, i.e. isothermal with the exception of a small temperature modulation. Quasi-isothermal MDSC is particularly beneficial when studying curing systems. The figure below contains the quasi-isothermal analysis of thermosetting epoxy resin. In the first part of the experiment, the curing is monitored at 100 °C for 160 min, and is evident as a decrease in C_p and a large exotherm in the Total Heat Flow. The second stage involved heating the sample under MDSC conditions at 3 °C/min to measure the T_g of the cured system, as well as residual cure.

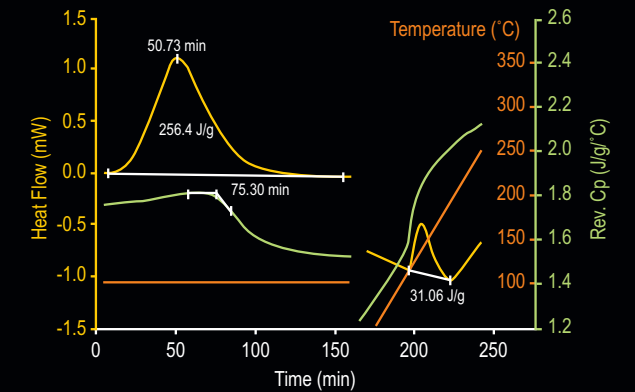
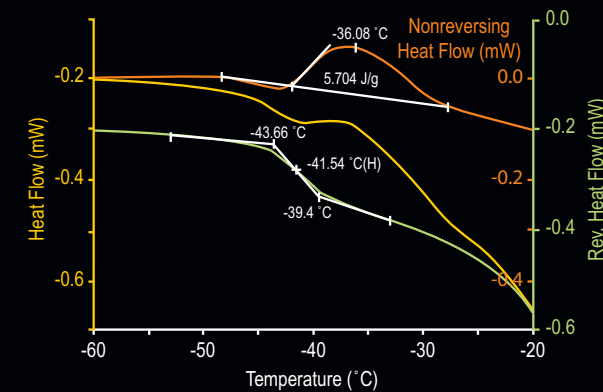
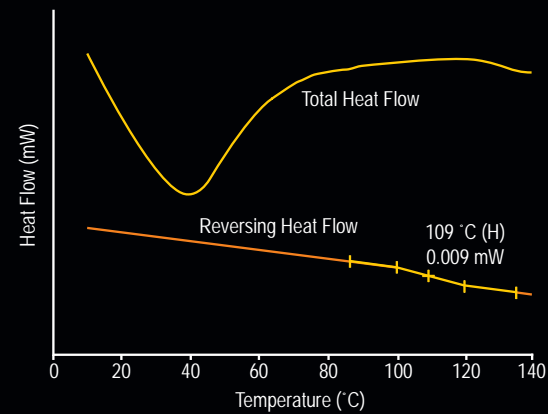
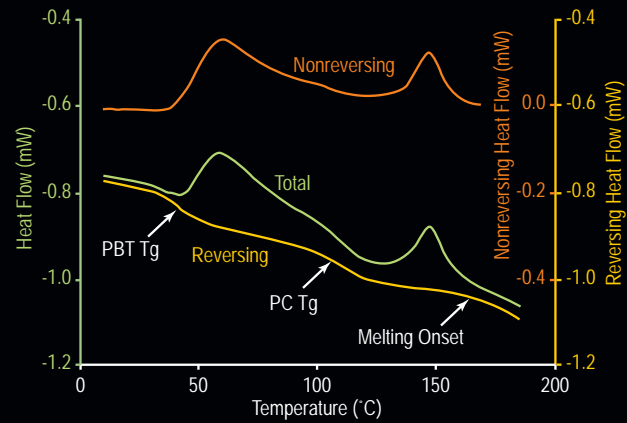

APPLICATIONS

TRANSITION TEMPERATURES

DSC provides rapid and precise determinations of transition temperatures using minimum amounts of a sample. Common temperature measurements include the following:

- Melting
- Glass Transition
- Thermal Stability
- Oxidation Onset
- Cure Onset
- Crystallization
- Polymorphic Transition
- Liquid Crystal
- Protein Denaturation
- Solid-Solid Transition

The composite below shows typical shapes for the main transitions observed in DSC.

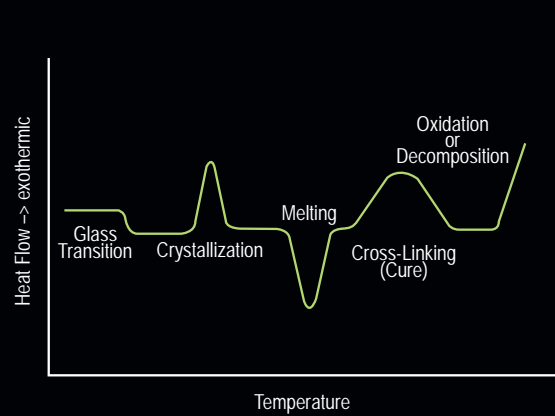

HEAT FLOW

Heat Flow is the universal detector, as all physical and chemical processes involve the exchange of heat. As such, the DSC Heat Flow signal is commonly used to measure and quantify a wide variety of transitions and events, often occurring in the same material as a function of temperature. The example below shows a pharmaceutical material which is undergoing a variety of physical changes as it is heated from subambient through its melting temperature. DSC is sensitive to all of these events.

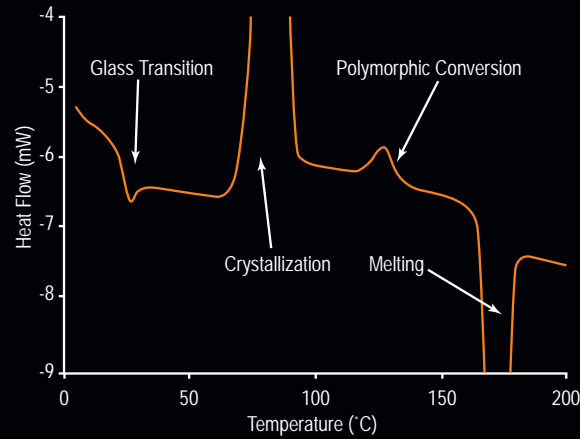

THERMAL HISTORY

DSC is an excellent tool for determining the thermal history of a polymer sample. In this experiment, the sample is subjected to a "heat-cool-reheat" cycle, and a comparison is made between the two heating cycles. The figure below contains the heat-cool-reheat results for a polyester sample. By comparing the first heating cycle (unknown thermal history) to the second heating cycle (known thermal history), information can be derived concerning the original morphology of the material. This can be useful in troubleshooting problems in performance or processing conditions.

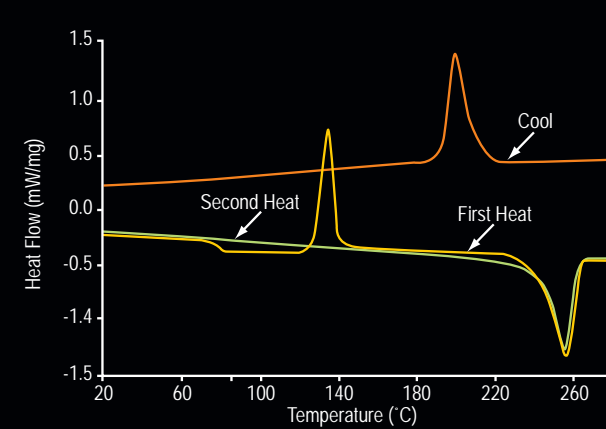

KINETICS

Kinetics is the study of the effects of time and temperature on a reaction. Isothermal crystallization is an example of an experiment in which kinetic information can be derived. The data below shows the isothermal crystallization results for a polymer sample which is being crystallized at a variety of temperatures below the melting point. By analyzing the time to peak heat flow for each temperature, various kinetic factors can be calculated including activation energy, rate constant, and conversion percent.

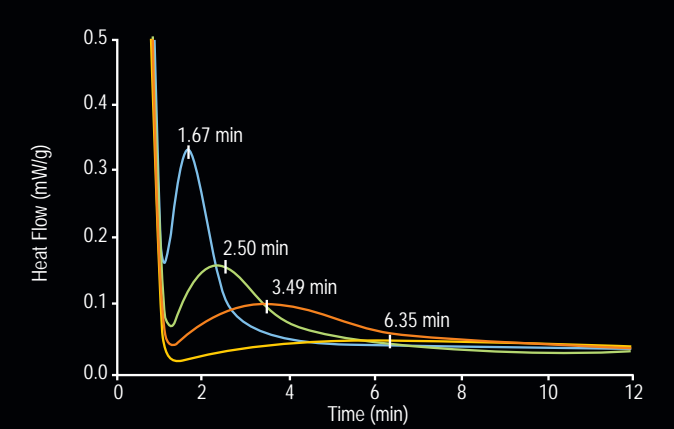

APPLICATIONS

PRESSURE (AND TIME)

Pressure DSC accelerates OIT analyses and “sharpens” the onset of the oxidation process. The figure below shows a comparative study of a series of two component polymer dispersions containing different levels of the same antioxidant. Clear performance differences are readily seen. The tests provided the same answer in under two days that took up to two months of traditional “field exposure” to obtain. Other common PDSC applications include a) thermoset resin cures, b) catalyst studies, and c) micro-scale simulations of chemical reactions.

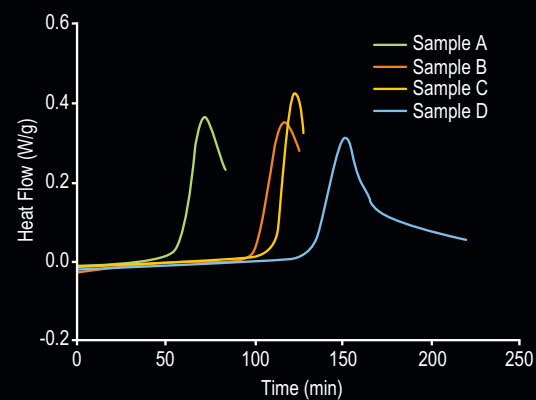

PHOTOCURING

The Photocalorimeter Accessory (PCA) provides a convenient tool to assess reactions initiated with UV/Visible light. The figure below compares two different acrylic formulations under the same conditions. The data shows that formulation A cures rapidly upon exposure to UV radiation, while formulation B reacts slower, and has both a longer time-to-peak and lower energy. In all PCA experiments, the peak shapes and transition energies are affected by the formulation chemistry, additives, initiators, and the purge gas used.

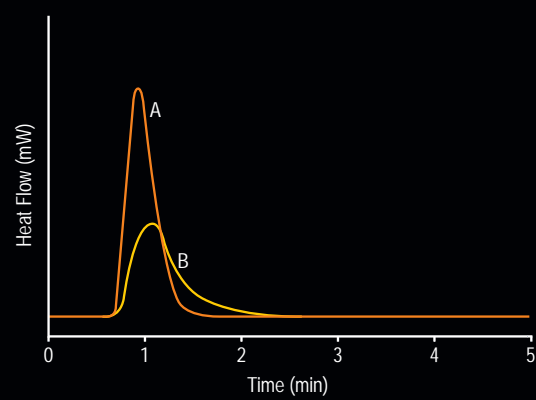

DEGREE OF CURE

The degree of thermoset cure can dramatically affect the processing and end-use conditions. DSC is often used to investigate and quantify the degree of cure for epoxy and other thermosetting materials. The figure below contains the data for the first and second heats of a thermoset material. The exotherm in the first heat indicates that the sample was not fully cured as received. By quantifying the residual cure, as well as comparing the glass transition temperatures of the two cycles, the degree of cure is easily determined.

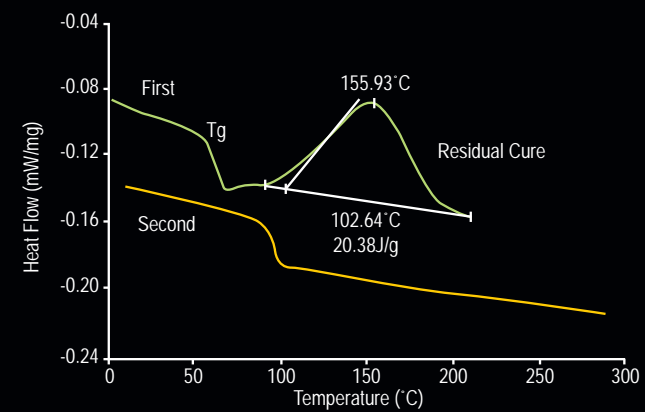

PHARMACEUTICAL POLYMORPH ANALYSIS

Pharmaceutical materials often exist in multiple crystal forms called polymorphs. These have the same chemical structure but a different crystalline structure which can result in significant differences in physical properties such as solubility, bioavailability and storage stability. DSC is the prevalent technique for the detection of pharmaceutical polymorphism. The DSC analysis of a pharmaceutical material in which three distinct polymorphs are detected on heating the amorphous compound is shown below.

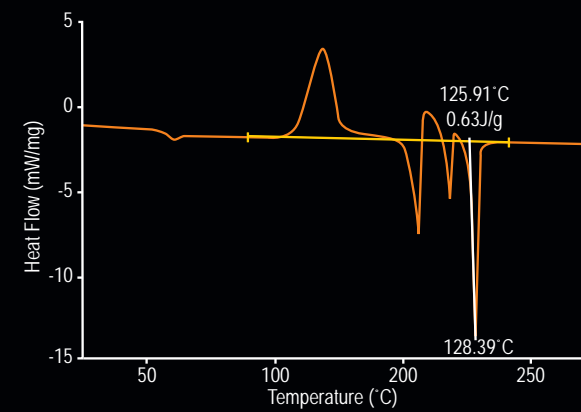

TGA

Q5000IR · Q500 · Q50 · TGA-HP



Thermogravimetric Analysis

Q5000 IR

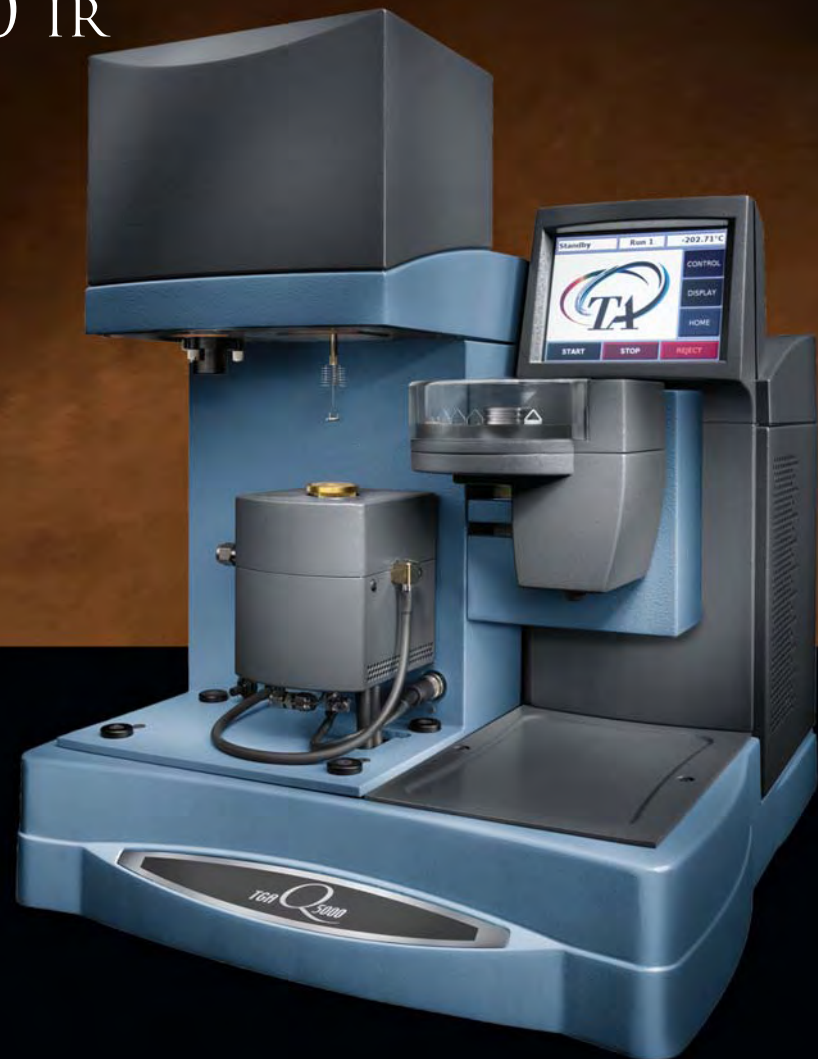

TECHNICAL SPECIFICATIONS

Temperature Controlled Thermobalance	Included
Dynamic Range	100 mg
Weighing Accuracy	+/- 0.1%
Weighing Precision	+/- 0.01%
Sensitivity	< 0.1 µg
Baseline Dynamic Drift*	< 10 µg
Signal Resolution	0.01 µg
Furnace Heating	Infrared
Temperature Range	Ambient to 1200 °C
Isothermal Temp Accuracy	+/- 1 °C
Ballistic Heating	>2000 °C/min
Linear Heating Rate	0.1 to 500 °C/min
Furnace Cooling (Forced air / N ₂)	1200 to 35 °C < 10 min
Vacuum	10 ⁻² torr
Temperature Calibration	Electromagnetic Coil/Curie Point Stds
Autosampler – 25 sample	Included
Hi-Res TGA™	Included
Auto Stepwise TGA	Included
Modulated TGA™	Included
TGA/MS Operation	Option
TGA/FTIR Operation	Option
Platinum™ Software	Included
Sample Pans	Platinum 50, 100 µL
	Platinum-HT, 100 µL
	Ceramic 100, 250 µL
	Aluminum 80 µL
	Aluminum Sealed Pan 20 µL

* From 50 to 1000 °C at 20 °C/min using empty platinum pans, no baseline / blank subtraction.

The highly automated Q5000 IR is the TGA best suited to meet the most demanding research applications. It outperforms all competitors in baseline flatness, sensitivity to low-level weight changes, and flexibility in both standard and high heating rate operation. Other powerful features include a 25-position integrated autosampler with contamination-free, sealed pan-punching capability, an internal electromagnet for easy Curie Point temperature calibration, Hi-Res™, Modulated TGA™, and Platinum™ software for user convenience in scheduling automatic calibration, verification and diagnostic tests to keep the Q5000 IR constantly in top operating condition.

Q500



TECHNICAL SPECIFICATIONS

Temperature Compensated Thermobalance	Included
Maximum Sample Weight	1 g
Weighing Precision	+/- 0.01%
Sensitivity	0.1 µg
Baseline Dynamic Drift*	< 50 µg
Furnace Heating	Resistance Wound
Evolved Gas Analysis Furnace (EGA)	Optional
Temperature Range	Ambient to 1000 °C
Isothermal Temp Accuracy	+/- 1 °C
Isothermal Temp Precision	+/- 0.1 °C
Controlled Heating Rate	0.01 to 100 °C/min
Furnace Cooling (forced air / N ₂)	1000 to 50 °C < 12 min
Temperature Calibration	Curie Point
Autosampler-16 sample	Optional
Hi-Res TGA™	Optional
Auto Stepwise TGA	Included
Modulated TGA™	Optional
TGA/MS Operation	Optional
TGA/FTIR Operation	Optional
Platinum™ Software	Included
Sample Pans	Platinum 50, 100 µL Ceramic 100, 250, 500 µL Aluminum 100 µL

* From 50 to 1,000 °C at 20 °C/min using empty platinum pans, no baseline / blank subtraction.

The Q500 is the world's #1 selling, research-grade thermogravimetric analyzer. Its field-proven performance arises from a responsive low-mass furnace, ultra-sensitive thermobalance, and efficient horizontal purge gas system with mass flow control. Its convenience, expandability and powerful, results-oriented software make the Q500 ideal for the multi-user laboratory where a wide variety of TGA applications are conducted, and where future expansion of analytical work is anticipated.

Q50



The rugged, reliable, and cost-effective Q50 TGA, with many features of the Q500, offers exceptional value as a compact, general-purpose thermogravimetric analyzer that typically outperforms competitive research-grade models. Its integral mass flow control, gas switching capability, superb software, and ease-of-use make the Q50 ideal in basic research, teaching, or in industrial laboratories that need quality results at a modest cost.

TECHNICAL SPECIFICATIONS

Temperature Compensated Thermobalance	Included
Maximum Sample Weight	1 g
Weighing Precision	+/- 0.01%
Sensitivity	0.1 µg
Baseline Dynamic Drift*	< 50 µg
Furnace Heating	Resistance Wound
EGA Furnace	Optional
Temperature Range	Ambient to 1000 °C
Isothermal Temp Accuracy	+/- 1 °C
Isothermal Temp Precision	+/- 0.1 °C
Controlled Heating Rate (°C/min)	0.1 to 100
Furnace Cooling (forced air / N ₂)	1000 to 50 °C <12 min
Temperature Calibration	Curie Point
Auto-Loader	Included
Auto Stepwise TGA	Included
TGA/MS Operation	Optional
TGA/FTIR Operation	Optional
Platinum™ Software	Included
Sample Pans	Platinum 50, 100 µL Ceramic 100, 250, 500 µL Aluminum 100 µL

* From 50 to 1,000 °C at 20 °C/min using empty platinum pans, no baseline / blank subtraction.

Q5000 IR TECHNOLOGY

FURNACE DESIGN AND TEMPERATURE MEASUREMENT

The Q5000 IR surpasses other models with its new infrared furnace that offers the widest range of linear (0.1 to 500 °C/min) and ballistic (>2000 °C/min) heating rates from ambient to 1200 °C. The innovative design employs four symmetrically-placed IR lamps, and a silicon carbide IR-absorbent enclosure. The quartz-lined furnace contains upper and lower heat shields and a unique control and measurement area thermocouple assembly. Other features include an integrated electromagnetic coil, forced-gas furnace cooling, and vacuum operation. The design benefits include rapid dynamic response and excellent performance and flexibility in standard, advanced (Hi-Res™ TGA; Modulated TGA™), and high heating rate experiments. The quartz liner's chemical inertness negates the need for special furnaces and is easily cleaned. Vacuum operation improves resolution of closely related events. The primary thermocouple ensures precise temperature control and provides accurate transition temperature measurement, while a redundant "safety" thermocouple disables the furnace if a temperature differential exceeds a set value. The ease of automated Curie Point temperature calibration is a unique Q5000 benefit.

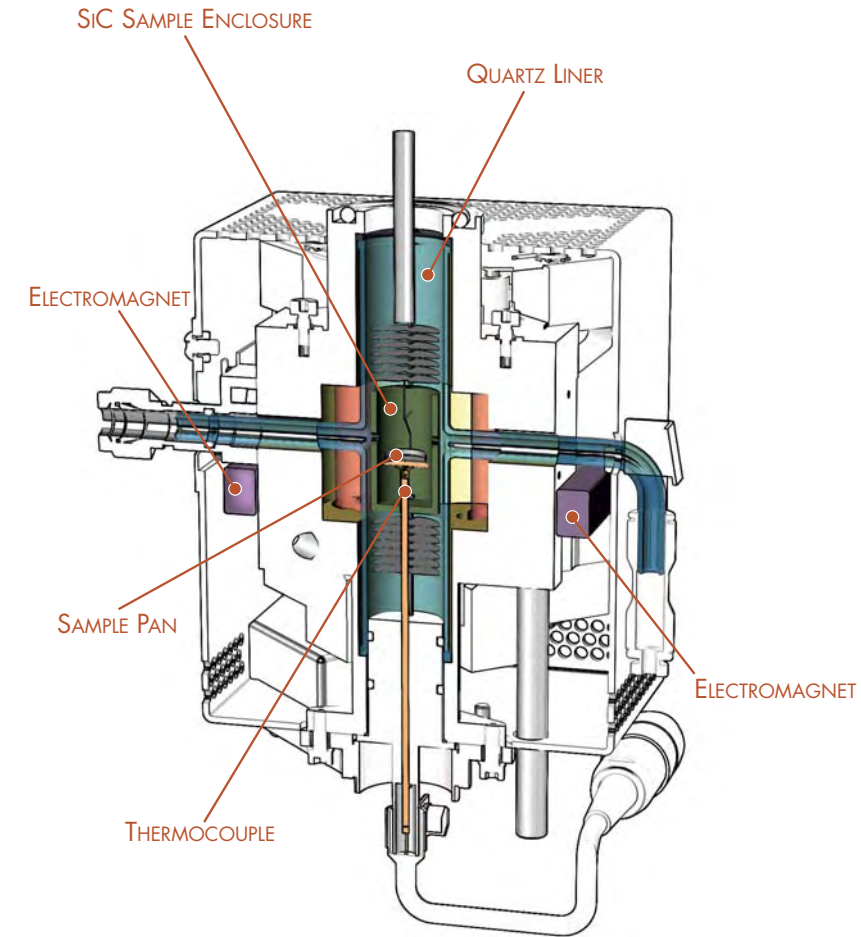
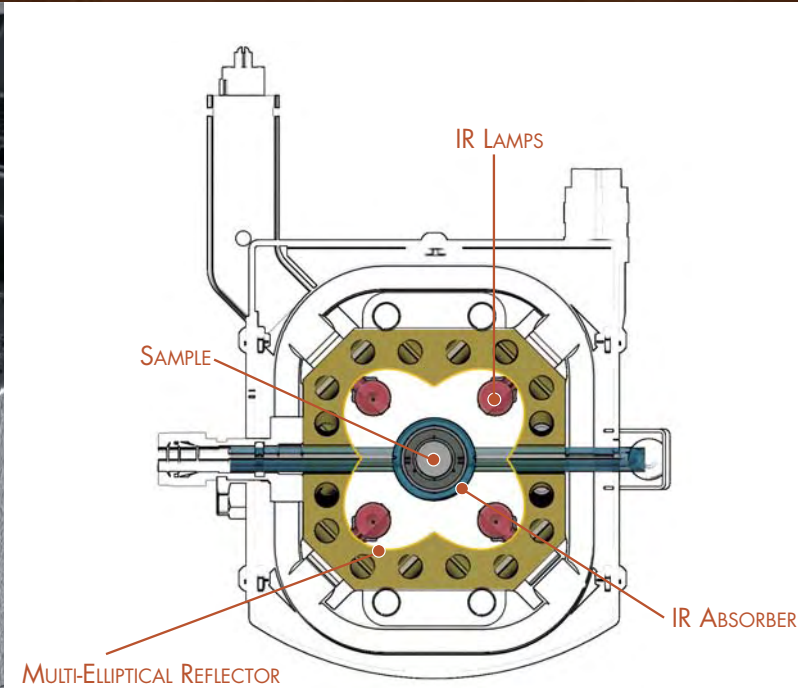

PURGE GAS SYSTEM

An efficient horizontal purge gas system that allows accurately metered gas to flow directly across the sample is integrated into the vertical thermo-balance / furnace design. A regulated portion of the gas is also directed through the balance chamber and the combined gases plus any sample effluent readily exit the system. An optional heated side arm is available which provides the highest level of sensitivity for off-gas (MS or FTIR) analysis. Digital mass flow controllers are used to provide accurate and precise metering and proportioning of the purge gases. The automatic low volume, high-speed switching valves deliver instantaneous change of purge gas that is critical when converting between inert and oxidizing atmospheres. Automatic buoyancy corrections provide more accurate weight change data, while the mass flow controllers improve data quality. Gas flow rates are available as stored data file signals.

Q5000 IR TECHNOLOGY

The highly automated Q5000 IR is the clear choice for complex TGA applications, for low-level detection of impurities, kinetic studies, off-gas analysis, and for high heating rate operation. Its design integrates a thermobalance engineered for maximum baseline flatness and high sensitivity, with the power and flexibility of an infrared furnace, and a proven horizontal purge gas system. Its many user convenience features include the 25-position autosampler, the integral electromagnet, and Platinum™ software for scheduling automatic calibration, verification and diagnostic tests.

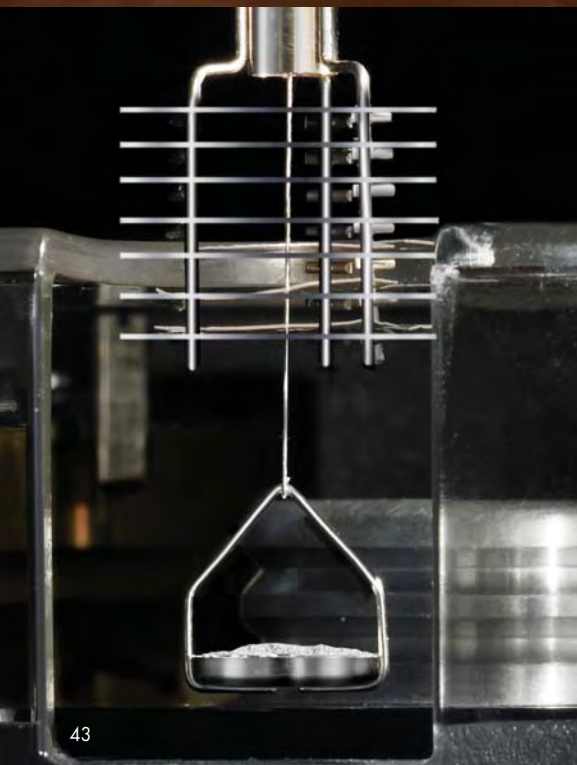

THERMOBALANCE

The heart of the Q5000 IR is a high performance thermobalance maintained at a constant 40.00 °C by three symmetrically arranged heaters in a well-insulated, gas-purged chamber. Isolated from the furnace by a water-cooled plate, the sensitive, null-balance design features the latest in precision weighing technology. Design benefits include sensitive, reliable operation over the entire temperature range (ambient to 1200 °C), unmatched dynamic baseline flatness, and exceptional accuracy and precision in weight change detection, essentially free from any vapor condensation or electrostatic forces.

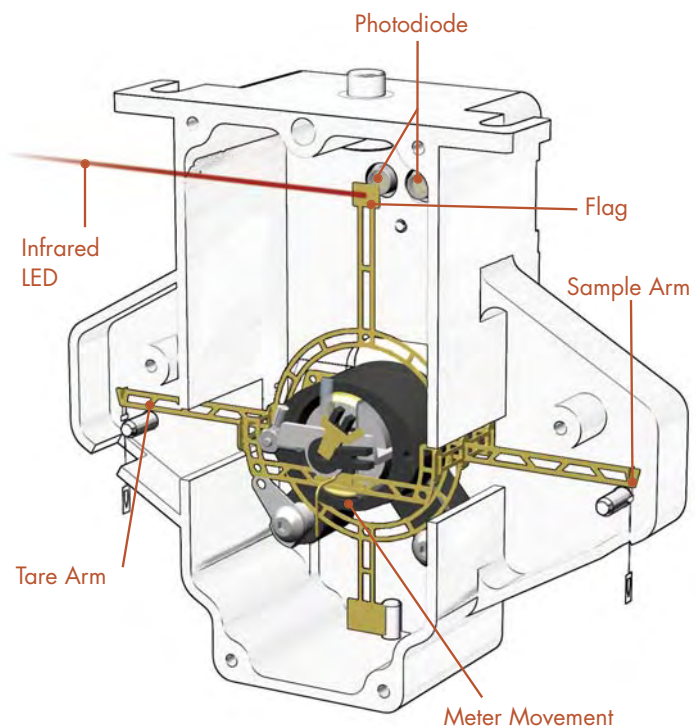

AUTOSAMPLER

The integrated Q5000 IR Autosampler features a programmable, 25-sample carousel and provides a new level of performance, flexibility and reliability in TGA sample analysis. All aspects of sample testing are automated and software controlled. Autosampler productivity is maximized by our Advantage™ software, which delivers pre-programmed analysis, comparison, and presentation of results. The autosampler design provides smooth loading and unloading of the sample pan without disturbing the balance. The carousel accommodates platinum, ceramic, and sealed aluminum pans. A special auto-sampler feature is the patented pan-punching mechanism designed to reliably open sealed aluminum pans used to protect atmosphere sensitive samples.

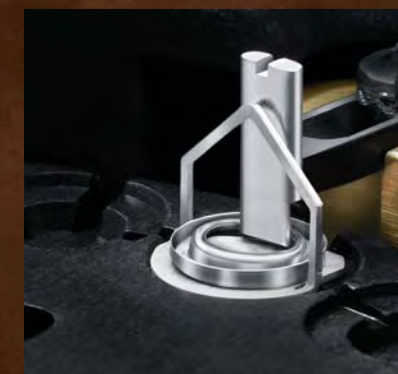

PERFORMANCE

DYNAMIC BASELINE STABILITY

The figure below shows a set of replicate Q5000 IR empty pan baseline runs from 50 °C to 1000 °C. Baseline drift in all cases was considerably below 10 µg, and the reproducibility at this level of performance was excellent! This makes the Q5000 IR the ideal instrument for high sensitivity detection of low level of components in a matrix, such as volatiles in a polymer, food, or pharmaceutical product.

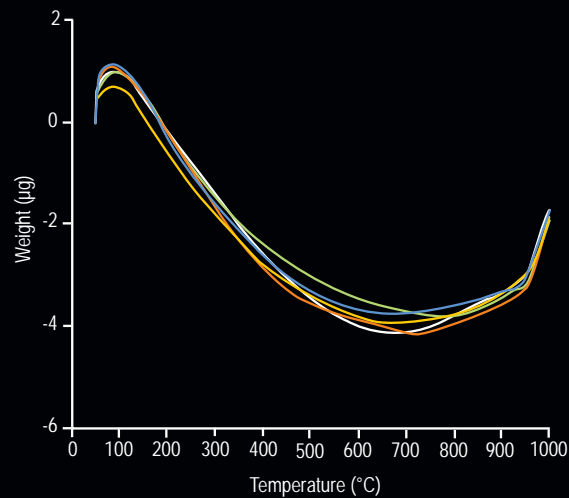

HEATING RATE PERFORMANCE

The IR-heating furnace of the Q5000IR TGA provides the widest range of heating rates available on the market. Ballistic heating from ambient to 1000 °C is accomplished in less than 1 minute, at instantaneous rates of over 2000 °C/min. Linear heating rates up to 500 °C/min are easily achieved, providing better simulation of rapid-heating processes and dramatically improving productivity and sample turnaround.

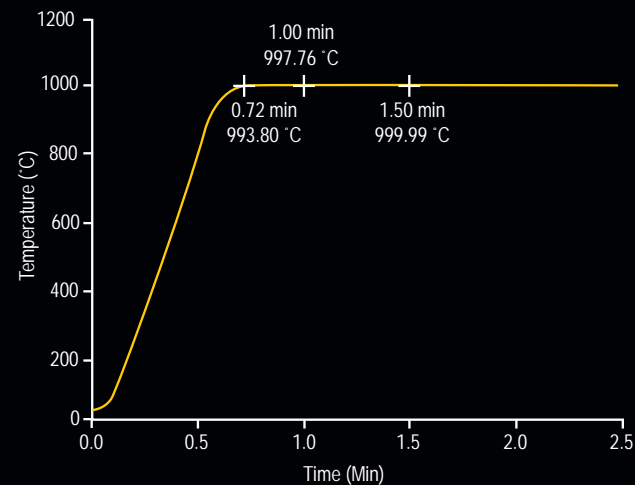

CURIE POINT CALIBRATION - ELECTROMAGNET

The figure below shows an overlay plot of a series of ICTAC certified, NIST traceable Curie Point reference materials used to calibrate a TGA apparatus. The data was collected on the Q5000 IR and agrees very well with the published values. The Q5000 IR has an integrated electromagnetic coil that greatly simplifies the work involved in performing Curie Point determinations, and provides for automated temperature calibration.

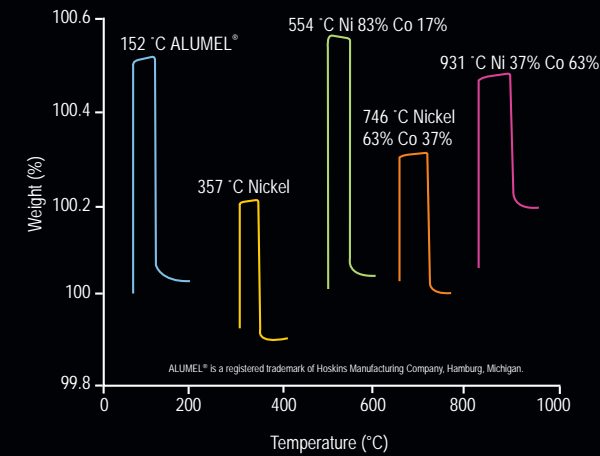

PERFORMANCE VERIFICATION

There is increasing interest in a means to verify the accuracy of measured weight changes (losses) by TGA. TA Instruments now offers certified Mass Loss Reference Materials for validation of instrument performance. These are 2%, 50% and 98% solutions of 2-ethoxyethylacetate (b.p.150 °C) in a stable higher boiling polyol. The figure below shows a plot of the decomposition profiles of 2-ethoxyethylacetate at all three concentrations. The data confirms that there is no interference from the polyol in the determination.

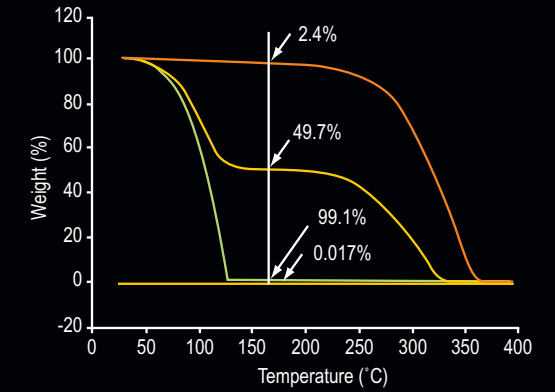

Q500 / Q50 TECHNOLOGY

Sensitive, precise, rugged and automated are terms that describe the TA Instruments Q500 and Q50 Thermogravimetric Analyzer (TGA). These are fourth generation products from the world leader in thermogravimetric analysis. Each represents an unparalleled investment because it delivers outstanding performance, is designed with the customer in mind, and is backed by superior support that is the hallmark of our company.



FURNACE

Our custom-designed furnace is a key element of a Q500 / Q50 TGA. It features low mass, rugged heater windings, and proprietary heater control technology. User benefits include rapid, accurate, and precise temperature and rate programming, plus optimized use in the Q500 of advanced techniques such as Hi-Res™ TGA and Modulated TGA™. Our reliable, long-life furnaces also increase the value of your investment.

TEMPERATURE CONTROL AND MEASUREMENT

Our unique, custom-designed system features a single control / sample thermocouple positioned immediately adjacent to the sample. A second thermocouple is located slightly above in the same sleeve. The design ensures that simultaneous heating rate control and sample temperature measurement are accurately and precisely accomplished. This innovative "control and feedback" design enables the system controller to program and maintain the temperature environment and heating rate selected by the operator. The second thermocouple also serves to automatically disable the furnace should the temperature difference between the thermocouples exceed a set value.

MASS FLOW CONTROL (WITH AUTOMATIC GAS SWITCHING)

Dual digital mass flow controllers (standard on all TA Instruments TGAs) provide accurate and precise purge gas metering. The automatic low volume, high-speed switching valves deliver instantaneous change of purge gas that is critical when converting between inert and oxidizing atmospheres. Gas flow rates are available as stored data file signals.

THERMOBALANCE

The heart of a Q500 / Q50 TGA is the accurate and reliable vertical thermobalance housed in a temperature-compensated environment. Unlike competitive instruments, no expensive circulator is required for optimal performance. It uses the field proven and industry-standard null-balance principle, which is free from the baseline complications also inherent in competitive designs. The Q50/500 balance provides the best accuracy and precision in weight change detection from ambient to 1000 °C, low baseline drift, and sensitive, reliable operation over the entire weight range.

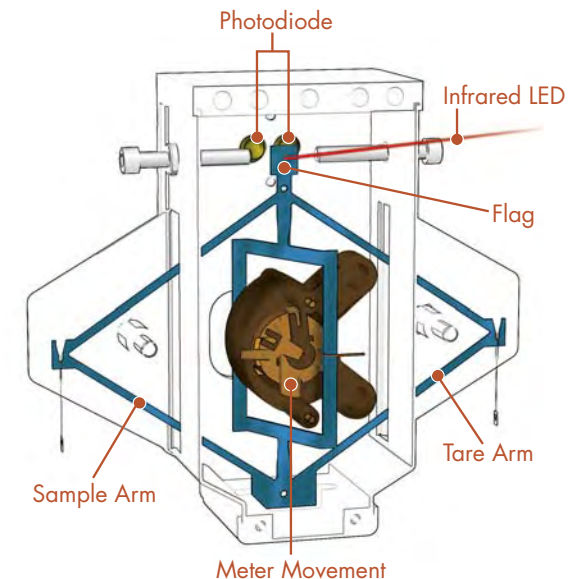

PURGE GAS SYSTEM

An efficient horizontal purge gas system allows accurately metered purge gas to flow directly across the sample, and is expertly integrated into the vertical thermobalance / furnace design. A regulated portion of the gas is also directed through the balance chamber to eliminate backflow, and the combined gases plus any sample effluent exit the system by a side arm. The design minimizes buoyancy effects, and optimizes removal of decomposition products from the sample area. The digital mass flow controllers improve data quality.



TGA ACCESSORIES & OPTIONS

EVOLVED GAS ANALYSIS (EGA) FURNACE

The rugged and reliable EGA is an optional, quartz-lined furnace for the Q500 or Q50. The liner is chemically inert to products produced from decomposition of the sample, resistant to adsorption of off-gas products, and its reduced internal volume ensures rapid exit of these materials from the sample chamber. These features make the EGA an ideal furnace for use in combined TGA/MS or TGA/FTIR studies.

AUTOSAMPLER

The Q500 Autosampler accessory is a programmable, multi-position sample carousel that allows fully automated analysis of up to 64 samples (16 samples per tray). All aspects of sample testing are automated and software controlled, including pan taring and loading, sample weighing, furnace movement, pan unloading, and furnace cooling. The autosampler has the flexibility to meet the needs of both research and QC laboratories. Autosampler productivity is maximized by our Advantage™ software, which permits pre-programmed analysis, comparison, and presentation of results.

TEMPERATURE CALIBRATION AND WEIGHT LOSS VERIFICATION

TA Instruments offers the widest range of ICTAC certified and NIST traceable Curie Point reference materials that permit full temperature calibration of the Q Series TGA modules over the range from 150 to 1120 °C. The advanced Q5000 IR has an internal electromagnet coil that permits temperature calibration with unprecedented convenience (see page 46). TA Instruments also offers certified Mass Loss Reference Materials for validation of instrument performance (see page 46).



EVOLVED GAS ANALYSIS

Evolved gas analysis involves the qualitative investigation of the evolved gas products from a TGA experiment. These products are the result of decomposition, but can also evolve from desorption, evaporation or chemical reactions. Evolved gas analysis is performed by interfacing a quadrupole mass spectrometer (MS) or Fourier transform infrared spectrometer (FTIR) to the exit port of the TGA furnace. Through the use of a heated transfer line, the evolved gas stream is delivered to the MS or FTIR instrument, and the compositional analysis is performed in real time. TA Instruments offers a 300 amu bench-top, quadrupole mass spectrometer with a heated capillary interface, and TGA module-specific interface kits for its Q5000 IR, Q500 and Q50 modules. A mass spectrum database is also available. A variety of FTIR suppliers provide gas cells and interfaces for use with all our TGA modules.

TA Instruments Thermogravimetric Analyzers are the ideal platform for evolved gas analysis studies. Each TA Instruments TGA features a horizontal purge stream over the sample, and a short path to the exit port. This eliminates dead volume in the furnace thereby reducing product dilution and optimizing EGA sensitivity. The Q500 and Q50 can be equipped with the quartz-lined evolved gas analysis (EGA) furnace which minimizes adsorption of effluent gases onto the furnace. The Q5000IR features heated EGA adapters designed to interface directly with the MS or FTIR transfer line. These adapters ensure continuous heating of the offgas stream through the furnace wall, dramatically reducing offgas condensation and improving EGA sensitivity.

TA Instruments Universal Analysis software supports the importation of MS (trend analysis) and FTIR data (Gram-Schmidt and Chemigram reconstructions), allowing TGA and EGA data to be displayed on a common axis of temperature and/or time.



EGA APPLICATIONS

TGA-MS: POLYMER ANALYSIS

The data below shows the TGA-MS results for the decomposition of ethylene vinyl acetate copolymer. The first step involves the decomposition of the vinyl acetate phase, resulting in the production of acetic acid. By monitoring amu signals typical of acetic acid, the production of the offgas compound is readily detected. The second step involves the thermal decomposition of the polyethylene phase, and its unique decomposition products are easily identified and recorded.

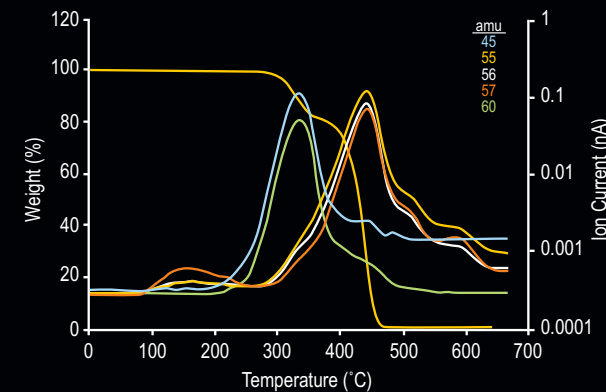

TGA-FTIR: PHENOLIC RESIN DECOMPOSITION

The figure below contains the TGA-FTIR results for the thermal decomposition of a phenolic resin adhesive. A Gram-Schmidt reconstruction of the time-resolved FTIR spectra is compared to the weight loss signal as a function of time and temperature. The inset image contains the FTIR spectrum of the offgas composition at 34.95 minutes, near the point of the maximum rate of decomposition. The FTIR spectrum corresponding to this temperature indicates that the offgas products are primarily composed of phenols, including bisphenol A, which is included as a comparison spectrum. This level of chemical specificity is useful in comparing similar products, quality control, and fingerprint analysis.

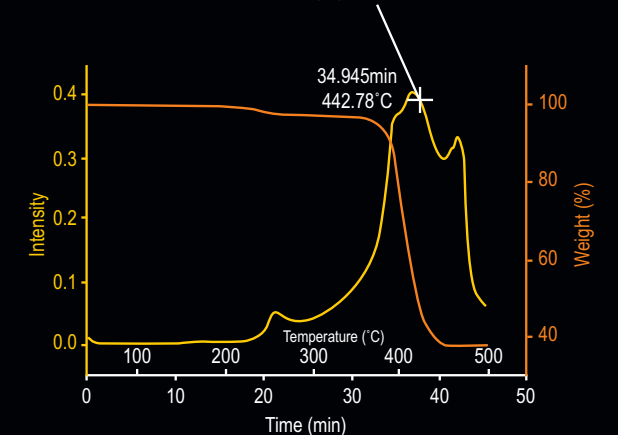
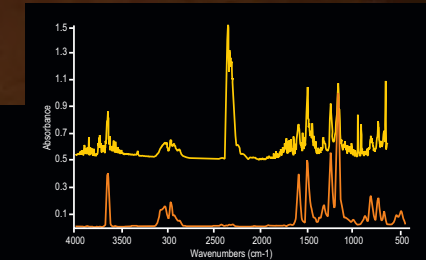

ADVANCED TGA TECHNIQUES

TA Instruments has been the pioneer in advancing the science of improved resolution TGA techniques, and in providing powerful but easily used software to accelerate material decomposition kinetic studies while preserving good data quality.



HIGH RESOLUTION TGA™ (HI-RES™ TGA)

Hi-Res TGA* is a patented furnace control technology that produces significant improvements over standard linear heating rate TGA in the separation of closely occurring decomposition events. Both the Q5000 IR and the Q500 designs are ideal for this purpose, with rapid response furnaces for tight precise temperature control and sensitive thermobalances designed to quickly detect small weight changes. Specific control algorithms (constant reaction rate and dynamic rate) are supplied with the Q5000 IR and are available for the Q500. Auto-stepwise isothermal is a third high resolution technique, and is supplied with all the Q Series™ TGA models.

MODULATED TGA™ (MTGA™)

MTGA** is another TA Instruments innovation that offers advantages for material decomposition studies. It is supplied with the Q5000 IR and as an option with the Q500 TGA. Its development arose from the proprietary heater control technology developed for Hi-Res TGA and MDSC®. MTGA produces model-free kinetic data, from which activation energy can be calculated and studied as a function of time, temperature, and conversion. It is easy-to-use and produces in a single run the kinetic data needed to improve industrial process productivity.

*U.S. Patent No. 5,165,792
Canadian Patent No. 2,051,578
European Patent No. 0494492

**U.S. Patent No. 6,113,261 and 6,336,741

SAMPLE PANS

Q5000 IR

Platinum (50 and 100 µL), high temperature platinum-HT (100 µL), ceramic (100 and 250 µL), and aluminum open (80 µL) and sealed (20 µL) pans are available for the Q5000 IR TGA. Platinum pans are recommended for most applications (ambient to 700 °C) for inertness and ease of cleaning. For operation to 1200 °C the ceramic pans (with ceramic bale) are recommended. The larger pan is best for higher volume / low density samples such as foams. The aluminum pans are also used in conjunction with aluminum lids to provide the sealed pan system. These new pans are designed exclusively for the Q5000 IR.



Q500 / Q50

Platinum (50 and 100 µL), and new style ceramic (100, 250, and 500 µL) pans are available for use with the Q500 and Q50 TGA modules from ambient to 1,000 °C. Platinum pans are recommended in most cases due to its inertness and ease of cleaning. The larger ceramic pans are best for analysis of higher volume / low density samples such as foams. They are also advised for use with samples that react with or form alloys with platinum. The aluminum (100 µL) pans are cost-effective substitute pans but cannot be used above 600 °C.



APPLICATIONS

Thermogravimetric Analysis measures the amount and rate of change in the weight of a material as a function of temperature or time in a controlled atmosphere. It is widely used in both research and quality control laboratories. TGA is particularly useful for the following measurements:

- Thermal stability
- Decomposition kinetics
- Composition
- Estimated lifetime
- Oxidative stability
- Moisture and volatile contents

HIGH SENSITIVITY VOLATILES ANALYSIS

Unwanted water or other volatiles in a formulation are often detrimental during product processing. The improved sensitivity of the Q5000 IR allows even small amounts of these undesirable components to be quantified. Sealed aluminum pans allow moisture sensitive samples to be isolated and queued in the autosampler until moments before analysis. The volatiles analysis for a small (2.4 mg) sample of polyethylene terephthalate (PET) bottle stock is shown below. The 0.2% weight change reflects an absolute weight loss of only 5.2 micrograms!

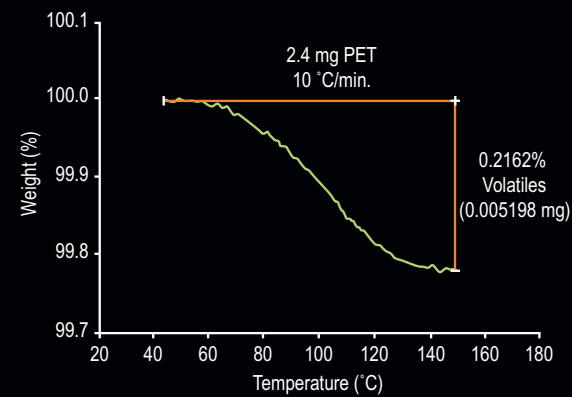

FASTER SEPARATIONS

For routine separation of organic and inorganic components, the agile response of the infrared furnace in the Q5000 IR sharply reduces sample analysis time by fast heating and quick cool-down. The figure below shows the determination of carbonate filler in a polypropylene matrix at 40 °C/min and at 500 °C/min respectively. The Q5000 IR allowed the analysis test time to be reduced by a factor of at least six (6), while preserving excellent data quantitation. Multiple sample analysis using the integrated 25-position autosampler would be a significant productivity enhancer in analyses of this type.

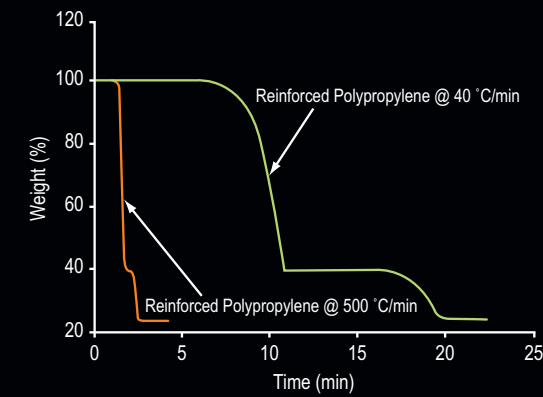

ACCURATE RESIDUALS

A common TGA analysis is the determination of the amount of inorganic filler or pigment in an organic matrix. A key element in the analysis is residue accuracy, which depends on baseline quality and tare reproducibility, two aspects which have been improved by an order of magnitude in the Q5000 IR. The figure below shows the decomposition of a 15 milligram sample of a polyolefin fruit juice package, in which the 0.28% residue has been measured to hundredths of a percent!

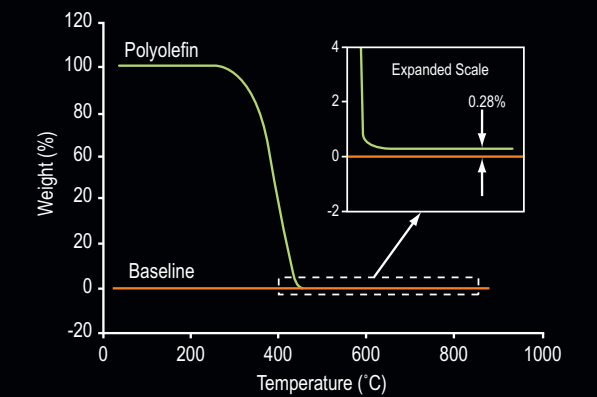

APPLICATIONS

MODULATED TGA™

The Figure below shows data from a MTGA™ kinetic study of the effect of temperature on the decomposition of 60% ethylene vinyl acetate (EVA) in a single analysis. The plot quantitatively shows the EVA decomposition profile and changes in activation energy as functions of temperature. The data supports a dual-step decomposition mechanism. MTGA can also monitor activation energy as a function of conversion, which indicates the mechanism involved. MTGA is supplied with the Q5000 IR and is available for the Q500.

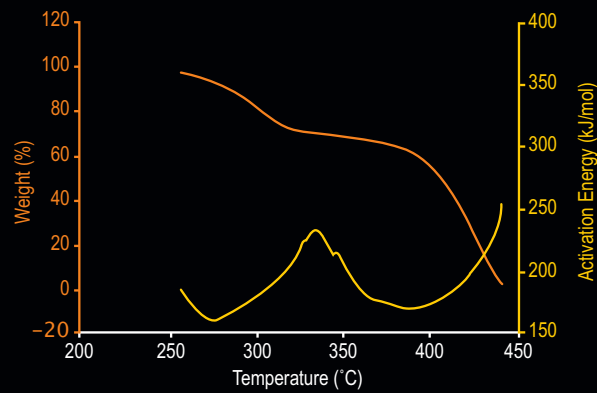

HIGH RESOLUTION™ TGA

The figure below compares the decomposition profile plots of a polyurethane material by standard and by Hi-Res™ TGA. The resolution superiority of the Hi-Res technique is clearly evident in both the TGA and first derivative (DTG) signals. The latter signal is especially useful in defining the onset and end set of the individual weight loss segments, as well as indicating subtle events that help to provide a “fingerprint” of the sample under the analysis conditions.

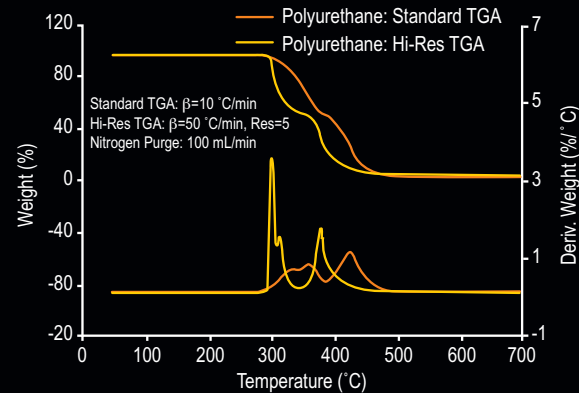

THERMAL STABILITY

TGA is often used to determine sample thermal stability and to reveal weight-loss decomposition profiles. The figure below shows typical thermal profiles for some common polymers (PVC, PMMA, HDPE, PTFE, and PI). The information allows materials selection for end uses where stability at specific temperatures is required.

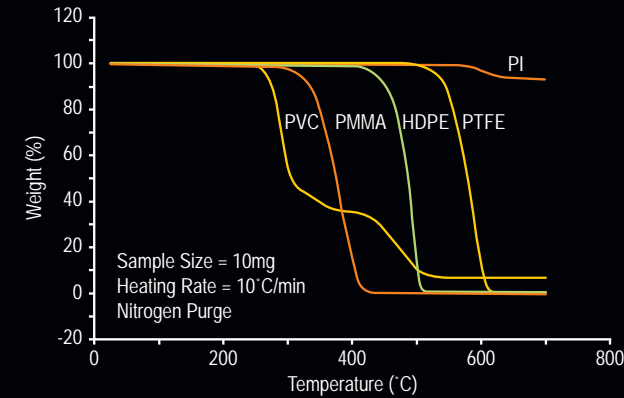

COMPOSITIONAL ANALYSIS

TGA is used to determine sample composition by measuring the weight of each component as it volatilizes or decomposes under controlled conditions of temperature, time, and atmosphere. The figure below shows quantitatively the differences in type, amount, and decomposition mechanism of the main polymers in three paint samples. More detailed examination of the profiles below 150 °C may reveal further information on the amount and possible nature of the carrier solvent (aqueous or oil) used in each paint.

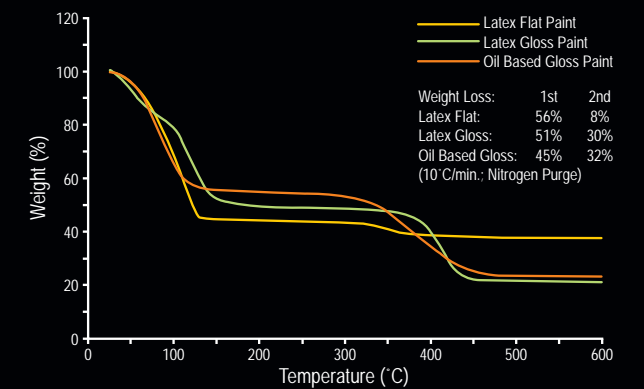

APPLICATIONS

VOLATILES ANALYSIS

TGA determinations of absorbed, bound, or occluded moisture, and organic volatiles are important analyses for product performance and environmental acceptance. Analysis of an organic salt hydrate in nitrogen atmosphere shows a bound-water content of 9.6%, and two lower temperature weight losses of 3.6% and 2.3% respectively. These losses are likely due to adsorbed moisture at the salt surface or held to it by weak attractive forces.

EFFECT OF ADDITIVES

The figure below compares the decomposition profiles of a polycarbonate material with and without an added flame retardant. The flame retarded material consistently decomposed at a temperature about 20-25 °C lower than that of the unmodified sample. The former material also lost a greater percentage of weight than the standard material (e.g., 48% vs. 28%) at a given temperature (e.g., 460 °C) during the decomposition step. This indicates that flame-retardant additives accelerate the polycarbonate decomposition. The purpose of the retardant material is to inhibit flame propagation.

VERIFICATION OF THERMAL EVENTS

TGA is very useful in conjunction with other thermal analysis techniques such as DSC and is often critical to understanding the true nature of thermal events. In the data below, a pharmaceutical material undergoes an endothermic transition above 125 °C which was previously thought to be melting. TGA analysis demonstrates considerable weight loss below 125 °C, which suggests that the endotherm is actually decomposition. DSC analysis at multiple rates exposes rate-dependence of this transition which confirms decomposition.

QUANTIFICATION OF FILLER CONTENT

TGA is a sensitive technique for analyzing and quantifying the filler content of polymeric composites. The figure below contains a comparison of the TGA results for a virgin and filled PET sample. The virgin material is first analyzed for comparison. By quantifying the weight loss of the initial lower-temperature decomposition, and comparing it to the oxidative decomposition in the second weight loss, the filler content of the composite material is accurately quantified.

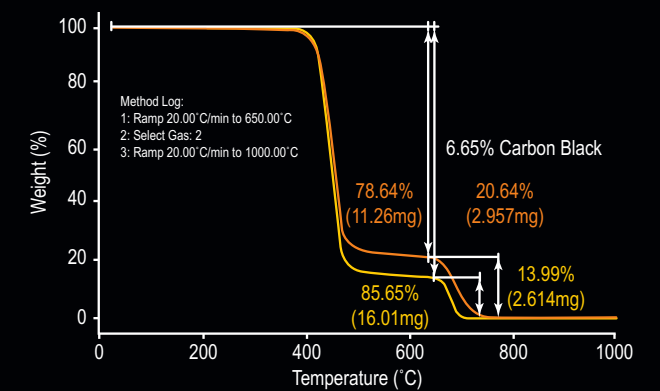
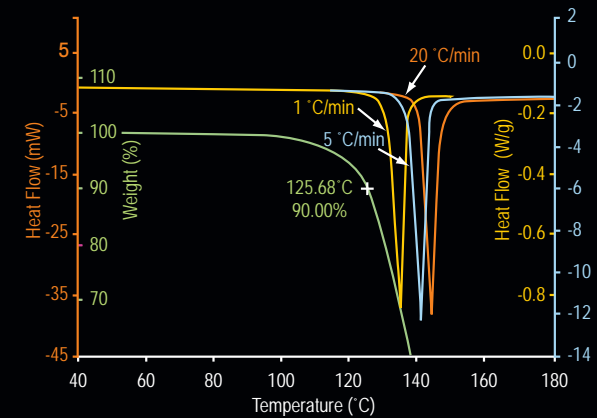
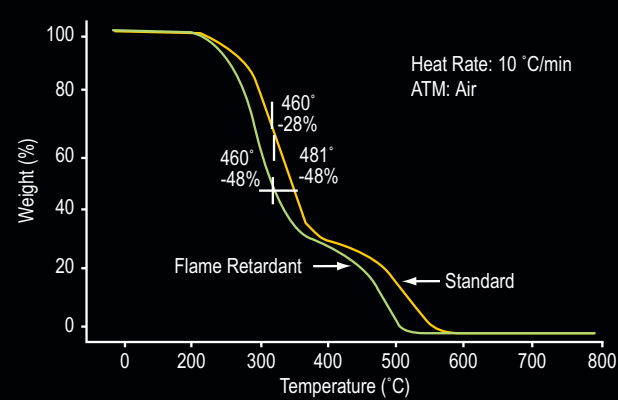
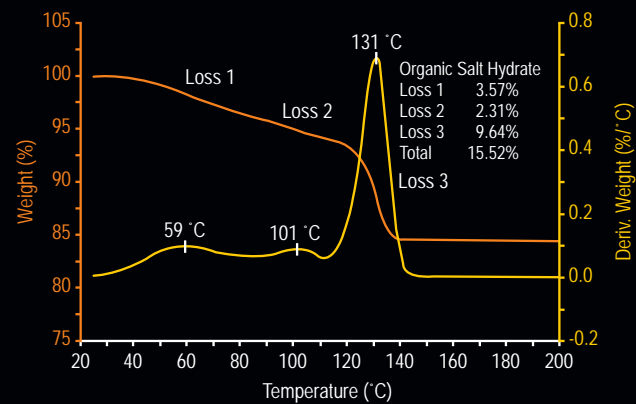

TGA-HP

The TA Instruments TGA-HP Series instruments are specialty gravimetric analyzers designed to provide unique capabilities for High-Pressure, Ultra-High Vacuum, and High-Temperature under static or dynamic reactive atmospheres.

The TGA-HP50 is our standard system, employing a high-sensitivity balance in a robust design. The TGA-HP50 can accommodate samples up to 5 g in mass, with a sensitivity of 0.5 microgram. The TGA-HP50 is the instrument of choice for high-pressure studies (up to 50 Bar) at measurement temperatures up to 800°C, and can accommodate a variety of gas compositions under high-pressure static or optional dynamic flow. The standard vacuum accessory provides for measurement at reduced pressures down to 1×10^{-3} torr; our optional Ultra High Vacuum (UHV) accessory can provide atmospheres down to 1×10^{-6} torr.

When higher pressures or corrosive gas atmospheres are required, the TGA-HP150 is recommended. This top-of-the line model provides static pressures up to 150 Bar, and utilizes an advanced Rubotherm Magnetic Suspension balance with a 25 g capacity. This allows the reaction chamber to be completely sealed, allowing for aggressive gas chemistry while isolating the microbalance assembly. The TGA-HP150 can be operated up to 750°C at the maximum pressure, and comes equipped with the standard vacuum accessory for low-vacuum studies. The optional UHV accessory is also available for studies under atmospheres down to 1×10^{-6} torr.

The TGA-HP150s is a specialized instrument designed for high temperature and pressure combinations. The maximum temperature of 1200°C is achieved safely in a unique double-wall reactor. The TGA-HP150s is equipped with a steam generator which makes it ideal for coal gasification studies, and includes 5 gas inlets for the maximum flexibility in dynamic reactive atmospheres.

All TGA-HP models can be interfaced for evolved gas analysis as described on page 51.



TECHNICAL SPECIFICATIONS

	TGA-HP 50	TGA-HP 150	TGA-HP 150s
Balance	Standard Balance	Rubotherm Magnetic Suspension	Rubotherm Magnetic Suspension
Maximum Sample Weight	5 g	25 g	25 g
Dynamic Range	500 mg	25 g	25 g
Weighing Accuracy	+/- 0.1%	± 0.0002%	± 0.0002%
Weighing precision	+/- 0.01%	±30 µg	±30 µg
Sensitivity	0.5 µg	10 µg	10 µg
Reactor Type	Single Block Inconel 625®	Single Block René41®	Double-Wall Alumina/316SS
Upper Temperature Limit			
Pretreatment	1000 °C	1000 °C	1200 °C
Testing	800 °C	750 °C	1200 °C
Pressure Limit	50 bar (725 PSI)	150 bar (2175 PSI)	50 bar (725 PSI)
Gas Inlets	3	3	5
Dynamic Flow-Dosing	Optional	Optional	Standard
Steam Generator	N/A	N/A	Standard
Vacuum	1×10^{-3} torr	1×10^{-3} torr	N/A
Optional High Vacuum	1×10^{-6} torr	1×10^{-6} torr	N/A
Corrosive Gas Compatibility	N/A	Recommended	Recommended

Inconel 625 is a registered trademark of Special Metals Corporation.
René 41 is a registered trademark of Teledyne Industries, Inc.

APPLICATIONS

CARBON DIOXIDE SEQUESTRATION

Zeolite and other inorganic molecular sieve membranes have shown potential for gas sequestration based on molecular size and shape because of their small pore sized, typically less than 1 nm, and their narrow pore size distribution. The size of these channels controls the size of the molecules or ions and therefore a zeolite like chabazite can act as a chemical sieve, allowing some ions to pass through while blocking others. The figure below contains the TGA-HP data for the adsorption of CO₂ into raw chabazite at 60 °C and at pressures up to 20 Bar. Note how the quantitative gravimetric sorption is easily determined using the TGA-HP technology.

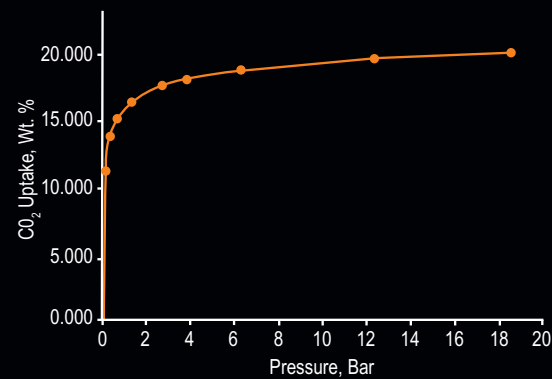

ADSORPTION OF NH₃ ON ZEOLITE CATALYST

The data in the Figure below shows the TGA-HP data of the adsorption of ammonia gas onto a zeolite matrix at two discrete temperatures, 30 °C and 400 °C, at pressures up to 7 Bar (ca. 100 psi). The TGA-HP is used to measure the quantitative capacity of the zeolite to adsorb the ammonia, thus allowing for the effective design of the exhaust stream catalyst technology.

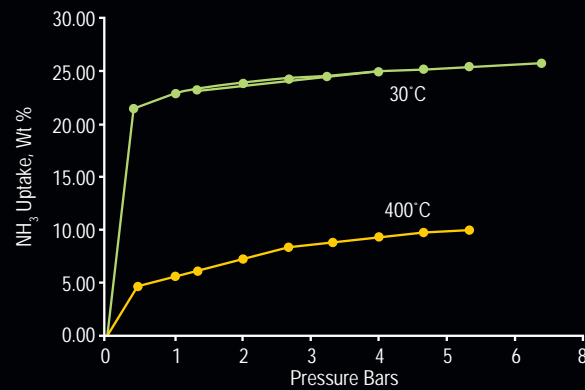

ADSORPTION OF H₂ ON CARBON

Recent research has focused on the development of transportable reversible systems for hydrogen storage with a high capacity. These systems are critical to the large-scale application of hydrogen fuel cells, in particular for mobile applications such as automotive use. A higher-energy efficiency is attainable with systems in which hydrogen is concentrated by physical adsorption onto a matrix material above 70 K. The TGA-HP is the ideal tool for measuring the adsorbent efficiency for hydrogen sorption. The data below shows the adsorption of H₂ gas onto an activated carbon matrix at 25 °C (273 K). Note how the adsorption is quantified over the wide pressure range from sub-atmospheric to nearly 80 Bar (ca. 1150 PSI).

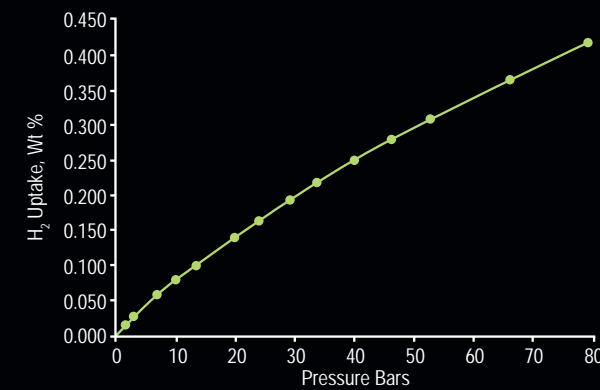

INVESTIGATION OF NANOPOROUS CARBON

Nanoporous carbon (NPC) is produced from the pyrolysis of hydrocarbons at high temperature, and results in a structurally disordered morphology with pores of ~4.5Å diameter. Similar to zeolites, there is considerable interest in using nanoporous carbon in adsorptive separation and catalyst technology because of the potential for selective discrimination based on molecular size and shape. The TGA-HP is the ideal instrument to investigate the adsorptive properties of NPC, at a variety of applied pressures and temperatures. The figure below contains the TGA-HP quantitative sorption data of NPC for CO₂ over a wide pressure range, at 35°C and 200°C.

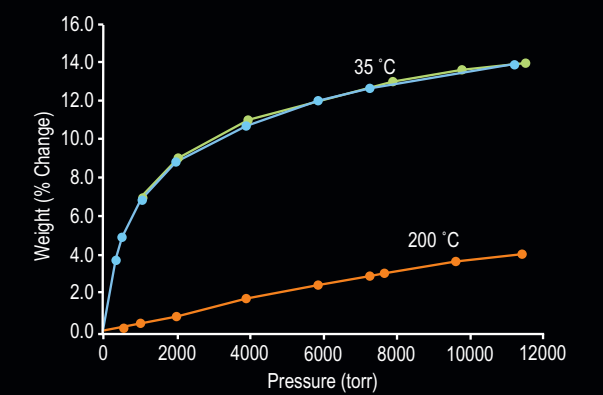

SDT
Q600



Simultaneous TGA/DSC

Q600



The Q600 provides a true simultaneous measurement of weight change (TGA) and true differential heat flow (DSC) on the same sample from ambient to 1,500 °C. It features a field-proven horizontal dual beam design with automatic beam growth compensation, and the ability to analyze two TGA samples simultaneously. DSC heat flow data is dynamically normalized using the instantaneous sample weight at any given temperature.

TECHNICAL SPECIFICATIONS

System Design	Horizontal Balance & Furnace
Balance Design	Dual Beam (growth compensated)
Sample Capacity	200 mg (350 mg including sample holder)
Balance Sensitivity	0.1 µg
Furnace Type	Bifilar Wound
Temperature Range	Ambient to 1500 °C
Heating Rate – Ambient to 1000 °C	0.1 to 100 °C/min
Heating Rate – Ambient to 1500 °C	0.1 to 25 °C/min
Furnace Cooling	Forced Air (1500 to 50 °C in < 30 min, 1000 °C in 50 °C in < 20 min)
Thermocouples	Platinum/Platinum-Rhodium (Type R)
Temperature Calibration	Curie Point or Metal Standards (1 to 5 Points)
DTA Sensitivity	0.001 °C
Calorimetric Accuracy/Precision	± 2% (based on metal standards)
Mass Flow Controller with Automatic Gas Switching	Included
Vacuum	to 7 Pa (0.05 torr)
Reactive Gas Capability	Included – separate gas tube
Dual Sample TGA	Included
Auto-Stepwise TGA	Included
Sample Pans	Platinum: 40 µL, 110 µL Alumina: 40 µL, 90 µL

SDT TECHNOLOGY

THERMOBALANCE

The Q600 features a highly reliable horizontal dual-balance mechanism that supports precise TGA and DSC measurements. It delivers superiority in weight signal measurements (sensitivity, accuracy and precision) than what is available from single beam devices, since the dual beam design virtually eliminates beam growth and buoyancy contributions to baseline drift. It also uniquely permits independent TGA measurements on two samples simultaneously.

TEMPERATURE CONTROL AND MEASUREMENT

A matched Platinum / Platinum-Rhodium thermocouple pair within the ceramic beams provides direct sample, reference and differential temperature measurements from ambient to 1,500 °C. This results in the best available sensitivity in detection of thermal events. Curie Point or pure metal standards can be used for single or multi-point temperature calibration. Calibration of the DSC signal using sapphire results in a differential heat flow (DSC) signal that is intrinsically superior to that from single beam devices.

FURNACE

The Q600 features a rugged, reliable, horizontal furnace encased in a perforated stainless steel cowling. The design ensures accurate and precise delivery of programmed and isothermal operation over the full temperature range from ambient to 1,500 °C. The design also provides for operator ease-of-use due to its automatic furnace opening / closing, easy sample loading and rapid post-experiment furnace cool-down.

PURGE GAS SYSTEM

A horizontal purge gas system with digital mass flow control and integral gas switching capability provides for precise metering of purge gas to the sample and reference pans. The design produces better baselines, prevents back diffusion and efficiently removes decomposition products from the sample area. A separate Inconel® gas inlet tube efficiently delivers reactive gas to the sample. The Q600 exhaust gas port can be readily connected to a MS or FTIR for component identification purposes.

© Inconel is a registered trademark of Special Metals Corporation

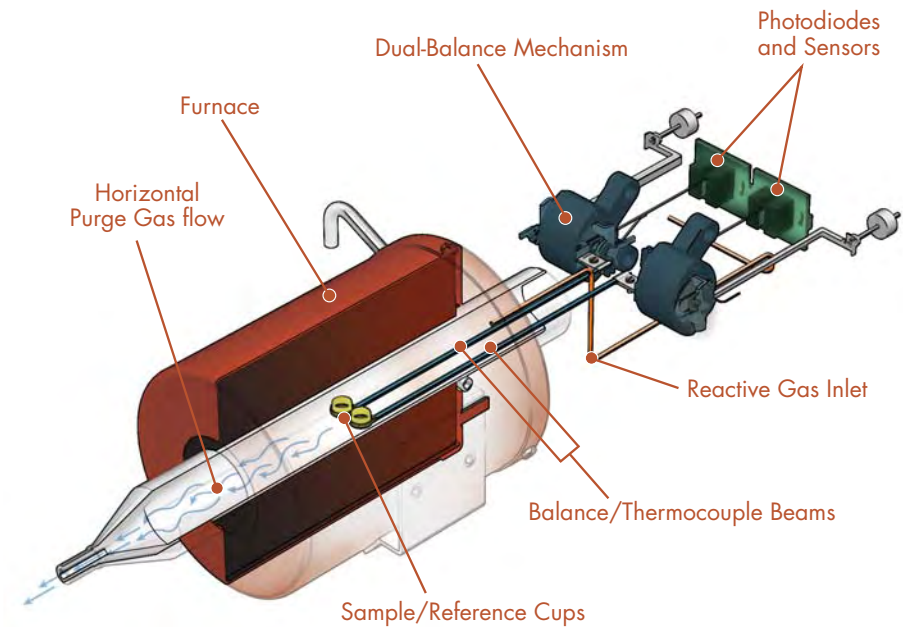
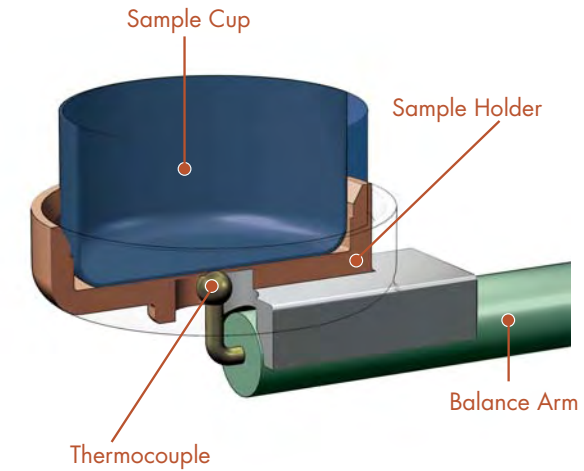

SDT TECHNOLOGY

HIGH RESOLUTION SDT

If separation of closely related weight losses cannot be obtained by standard linear heating conditions the Q600 offers an automated version of StepWise Isothermal (SWI), the classical technique for improved TGA resolution. The stepwise isothermal approach consists of heating at a constant rate until a weight change begins (as determined by an operator-chosen rate or amount of weight loss) and then holding isothermally until the weight change is complete. This sequence of heating and isothermal holding is repeated for each weight change encountered. The result is optimum weight loss resolution.

TEMPERATURE CALIBRATION AND WEIGHT LOSS VERIFICATION

TA Instruments offers the widest range of ICTAC certified and NIST traceable Curie Point reference materials that permit SDT apparatus temperature calibration over the range from 150 to 1,120 °C. TA Instruments also offers certified Mass Loss Reference Materials for validation of SDT instrument performance.

Q600 SAMPLE PANS

Platinum pans (40 and 110 µL), and ceramic cups (40 and 90 µL) are available for use with the Q600. The platinum cups are recommended for operation to 1000 °C, and for their general inertness and ease of cleaning. The ceramic cups are advised for operation to 1,500 °C, and for samples that react with platinum.



APPLICATIONS

IMPROVED DSC DATA

In SDT experiments, superior accuracy in DSC data is obtained when the instantaneous weight rather than the initial sample weight is used in heat flow calculations. The figure below shows data for sodium chloride (which loses weight on heating) cycled through its melt four times, and the heat of fusion (J/g) determined using the instantaneous weight. The table below shows a comparison of this data versus an identical experiment where the initial sample weight was used for calculating the DSC data in each cycle. The differences in reproducibility are very apparent.

	Cycle 1	Cycle 2	Cycle 3	Cycle 4
Heat of Fusion Initial Weight (J/g)	468.7	384.1	324.7	266.9
Heat of Fusion Instantaneous Weight (J/g)	468.7	459.1	459.2	464.4

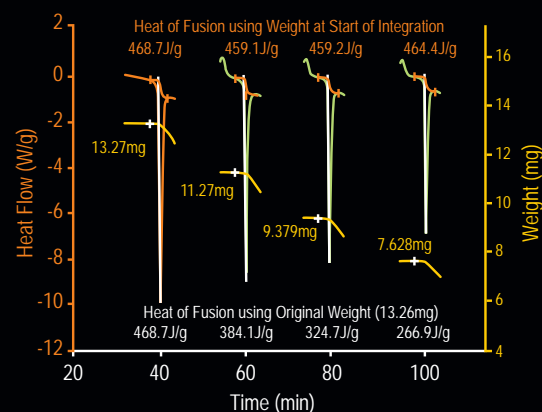

HIGH SENSITIVITY

The figure below shows a high sensitivity application of Q600 in which a small (3 mg) sample of sodium tungstate is analyzed at 10 °C/min from ambient to 800 °C. The TGA and derivative TGA (DTG) signals quantitatively record the dehydration step. The DSC trace quantitatively shows the loss of water plus higher temperature solid state phase and melting transitions respectively. The latter pair are thermal events where no weight loss occurs.

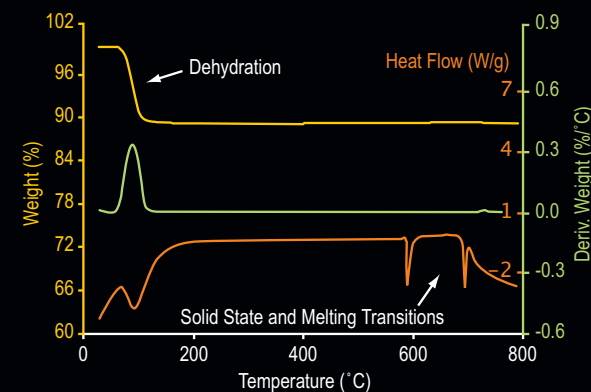

SIMULTANEOUS DSC/TGA

The figure below contains simultaneous DSC and TGA data to 1,300 °C for a soda ash sample. The TGA curve quantitatively tracks the dehydration and the onset of a higher temperature decomposition. The DSC signal quantitatively reveals transitions associated with the dehydration, a polymorphic phase transition and the high temperature melt. The inset shows details about the phase transition. In the Q600, heat flow integrations are automatically normalized using the dynamic weight at the start of each transition.

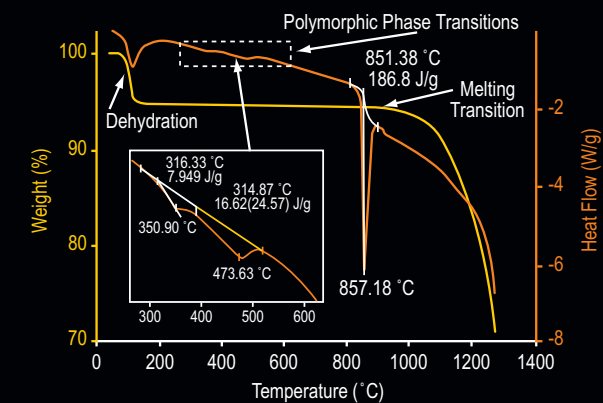

Vapor Sorption Analysis

VTI-SA · Q5000sA



VTI-SA



The Model VTI-SA Vapor Sorption Analyzer is a continuous vapor flow sorption instrument for obtaining precision water and organic vapor isotherms at temperatures ranging from 5°C to 60°C at ambient pressure. The VTI-SA Analyzer embodies the features of VTI's original SGA design with almost two decades of field-proven performance: the isothermal aluminum block construction, the three isolated thermal zones and chilled-mirror dew point analyzer for primary humidity measurements... all to provide excellent temperature and RH stability.

TECHNICAL SPECIFICATIONS

Balance Capacity	1.5 g / 5g
Dynamic Range	150 mg / 500 mg
Weighing Accuracy	+/- 0.1%
Weighing Precision	+/- 0.01%
Sensitivity	0.1 µg / 0.5 µg
Signal Resolution	0.1 µg / 0.5 µg
Temperature Control	Peltier Elements
Experimental Temperature Range	5 to 60 °C
Maximum Drying Temperature	150 °C
Isothermal Stability	+/- 0.1 °C
Relative Humidity Control Range	2 to 98% RH
Accuracy	+/- 1% RH
Humidity Control	Closed Loop, Dew Point Analyzer
Organic Solvent Capability	Included

VTI-SA TECHNOLOGY



SYMMETRICAL MICROBALANCE DESIGN

The VTI-SA Analyzer is a symmetrical vapor sorption instrument where both the sample and reference chambers are exposed to the same conditions of temperature and humidity. In this field-proven design water or organic vapor sorption onto the hangdown wires and sample holders are differentially eliminated and the resultant data represents the uptake by the sample alone. This eliminates the need for background subtraction experiments and associated uncertainty typical in competitive, asymmetrical systems.

RESOLUTION AND STABILITY OF THE MICROBALANCE

The VTI-SA balance boasts a 0.1 microgram sensitivity optimized for pharmaceutical applications. The system can also be configured with a 5g capacity balance for larger samples. Also, for more effective work in pharmaceutical studies, the design provides an enhanced stability by maintaining the balance compartment at a constant temperature, independent of the sample temperature. Because the balance is maintained at constant temperature, the user has the option of drying the sample at temperatures other than the experimental temperature, or to run different temperature and RH profiles without removing the sample.

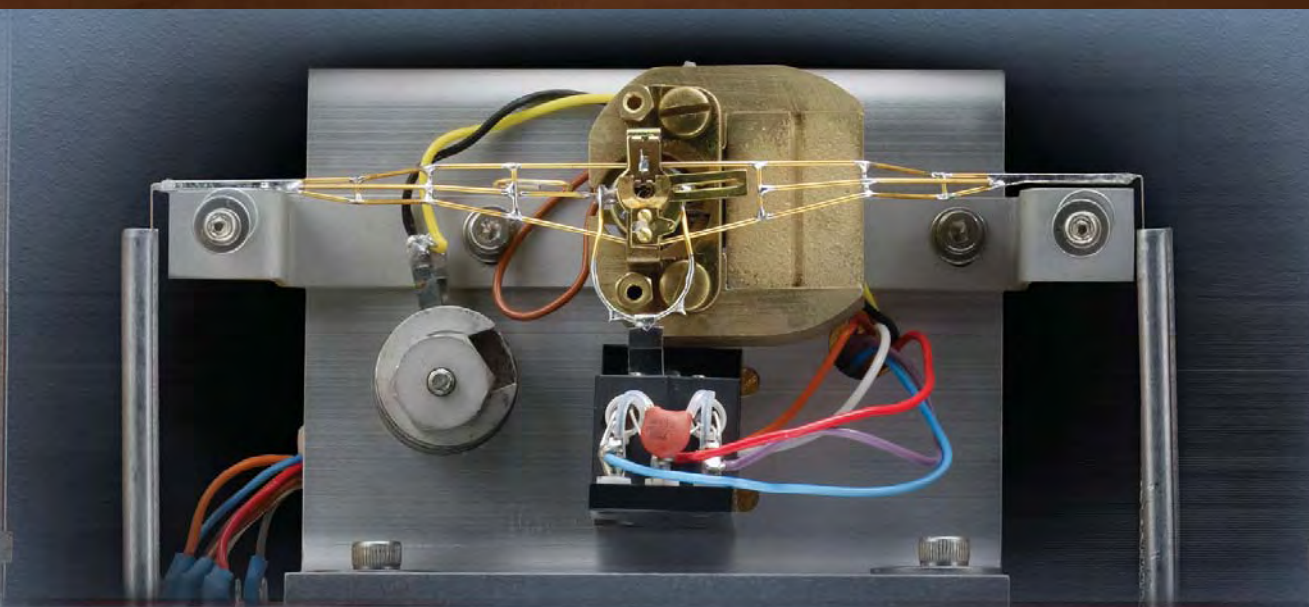

VTI-SA TECHNOLOGY

SAMPLE CHAMBER DESIGN

In the VTI-SA Analyzer the sample and reference chambers are located within an aluminum block maintained at constant temperature (within $\pm 0.1^\circ\text{C}$) by precise Peltier control elements. Our unique aluminum block design has two distinct advantages. First, due to the high thermal conductivity of the aluminum, thermal gradients within the chambers are minimal. Secondly, because the chamber is a metal block, the issues of static electricity are eliminated. This feature is especially useful when analyzing finely divided powders, as is often the case with pharmaceuticals. The sample temperature is measured with a highly accurate, calibrated platinum resistance thermometer. For pre-experimental drying of the sample, the block can be heated to 150°C using resistance cartridge heaters.



PRECISION HUMIDITY MEASUREMENTS

As part of our standard design, the VTI-SA uses a chilled mirror dew point analyzer (a NIST-traceable standard for humidity) to determine and control the humidity at the sample. In applications where RH control is critical (as in most pharmaceutical studies), chilled-mirror dew point analyzers are the preferred method, because of the absence of drift and long-term stability.

SORPTION TESTING USING AN ORGANIC VAPOR

The VTI-SA can also be used for organic vapor sorption. In the VTI-SA, the concentration of the organic vapor in the gas stream reaching the sample is determined by the fraction of gas going through the organic solvent evaporator and the fraction of dry gas. In competitive systems, assumptions are made that the evaporator is 100% efficient and that the temperature of the evaporator is constant from low to high concentrations. The VTI-SA system measures the temperature of the organic solvent in the evaporator and uses this information together with the Wagner equation to control the organic vapor concentration in the gas phase. This method solves the issue of the adiabatic cooling of the solvent, a major source of error in competitive systems.

The solvent containers/evaporators are easily removed so there is no need for decontamination or cleaning of the system when changing organic solvents or reverting to water adsorption experiments. For safety, the evaporator compartment is purged with dry nitrogen and fitted with a combustible gas sensor with an audible alarm that when triggered shuts down the power to the analyzer.



VTI-SA3 SORPTION ANALYZER

The VTI-SA3 is a unique "triple balance" instrument to increase adsorption-testing throughput. This analyzer runs up to 3 samples simultaneously under identical conditions of temperature and humidity for sorption testing in pharmaceutical research, screening and quality control applications. The VTI-SA3 uses field-proven sorption testing technology based on almost 20 years of experience with our predecessor SGA Series Analyzers, and delivers performance equivalent to the VTI-SA including standard capability for testing with organic vapors.

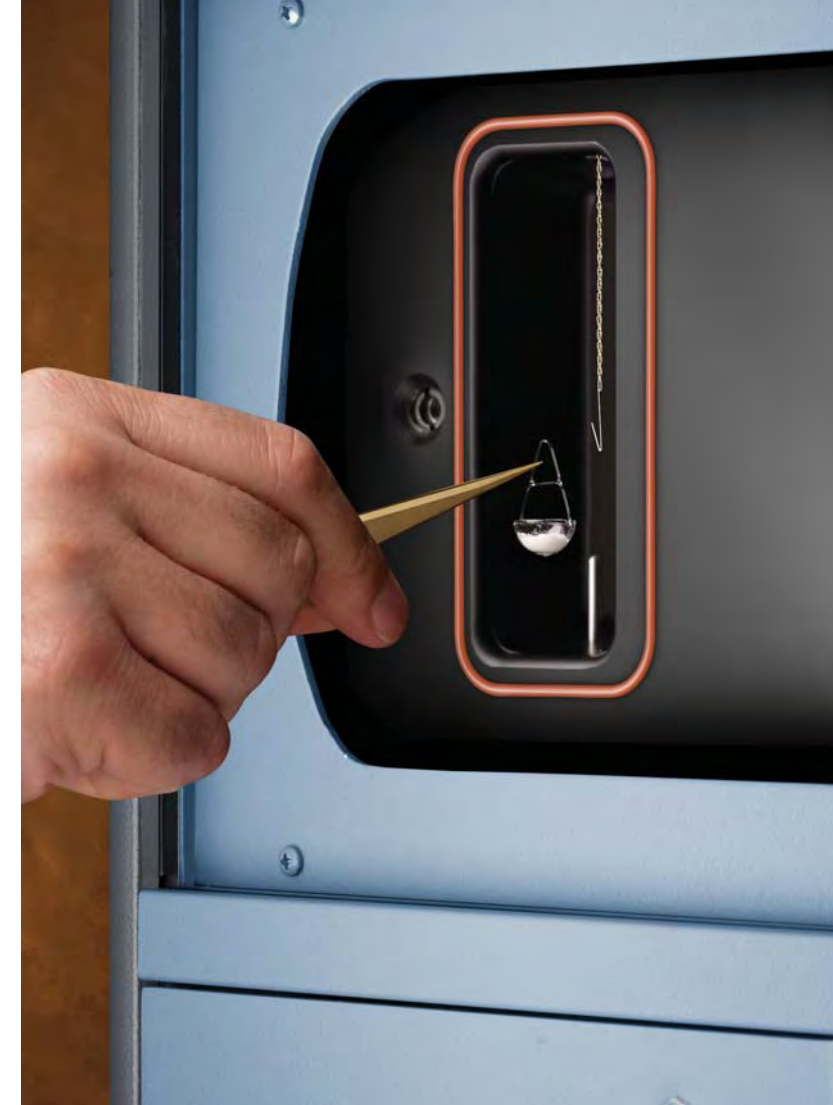

Q5000 SA

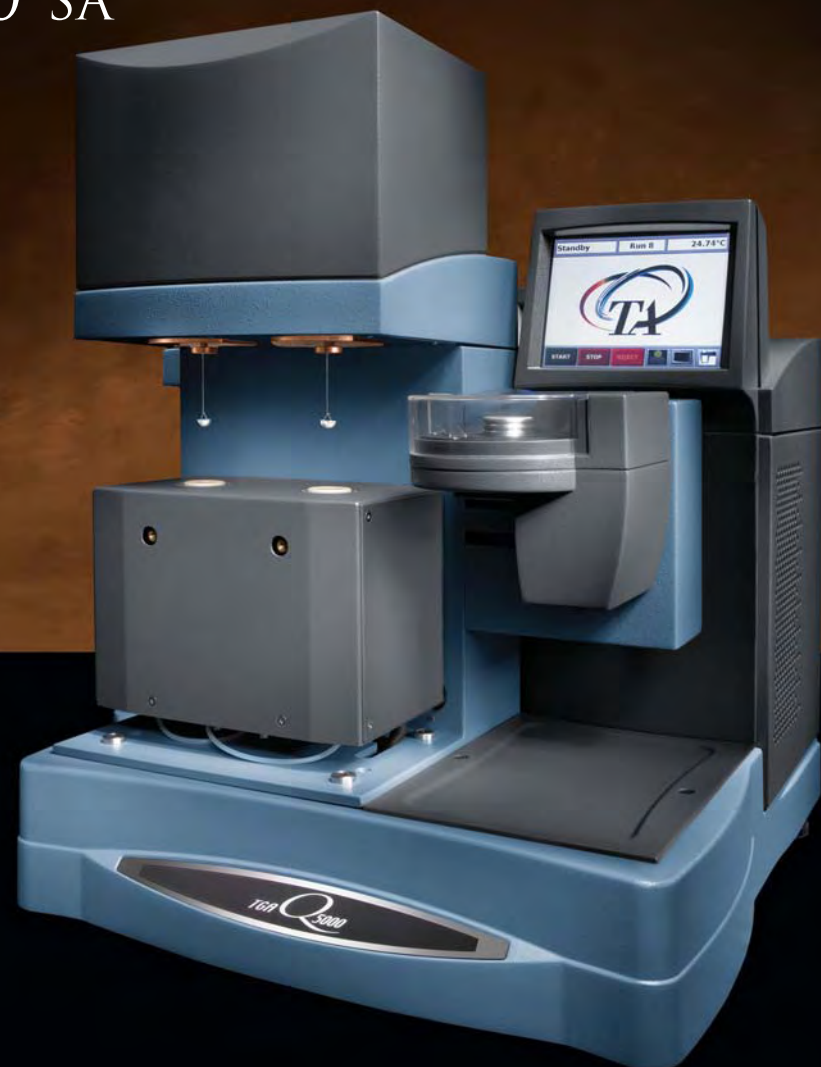

The Q5000 SA is designed for manual or automated sorption analysis of materials under controlled conditions of temperature and relative humidity (RH). Its design integrates our latest high sensitivity, temperature-controlled thermobalance with an innovative humidity generation system, multi-position autosampler, and powerful Advantage™ software with technique specific programs and Platinum™ features. The patented Q5000 SA delivers the performance and reliability required in a leading sorption analyzer and in a compact, user-friendly design.

TECHNICAL SPECIFICATIONS

Temperature Controlled Thermobalance	Included
Dynamic Range	100 mg
Weighing Accuracy	+/- 0.1%
Weighing Precision	+/- 0.01%
Sensitivity	< 0.1 µg
Baseline Drift*	< 5 µg
Signal Resolution	0.01 µg
Temperature Control	Peltier Elements
Temperature Range	5 to 85 °C
Isothermal Stability	+/- 0.1 °C
Relative Humidity Control Range	0 to 98 %RH
Accuracy	+/- 1 % RH
Autosampler – 10 samples**	Included
Platinum™ Software	Included
Sample Pans	Metal Coated Quartz 180 µL Platinum 50, 100 µL Aluminum Sealed Pan 20 µL

* Over 24 hours at 25 °C and 20 % RH with empty metal coated quartz pans

** Optional tray accommodates 25 samples for use with platinum and sealed aluminum pans

HUMIDITY CONTROL CHAMBER

The patented design features a pair of mass flow controllers (MFCs) that accurately meter and proportion gas to a symmetrical, well-insulated, aluminum block. The block contains a humidifier, gas transmission and mixing lines, plus easily accessible, identically arranged, sample and reference measurement chambers. Temperature regulation of the block interior from 5 °C to 85 °C is performed by four thermoelectric (Peltier) devices in conjunction with a thermistor in a closed-loop system. The mass flow controllers adjust the amounts of wet (saturated) and dry gas to obtain humidities from 0 to 98 %RH. Identical sensors are located adjacent to the sample and reference crucibles, and provide a continuous indication of humidity. Benefits of the design include precise temperature control and highly consistent atmosphere within the sample and reference chambers.

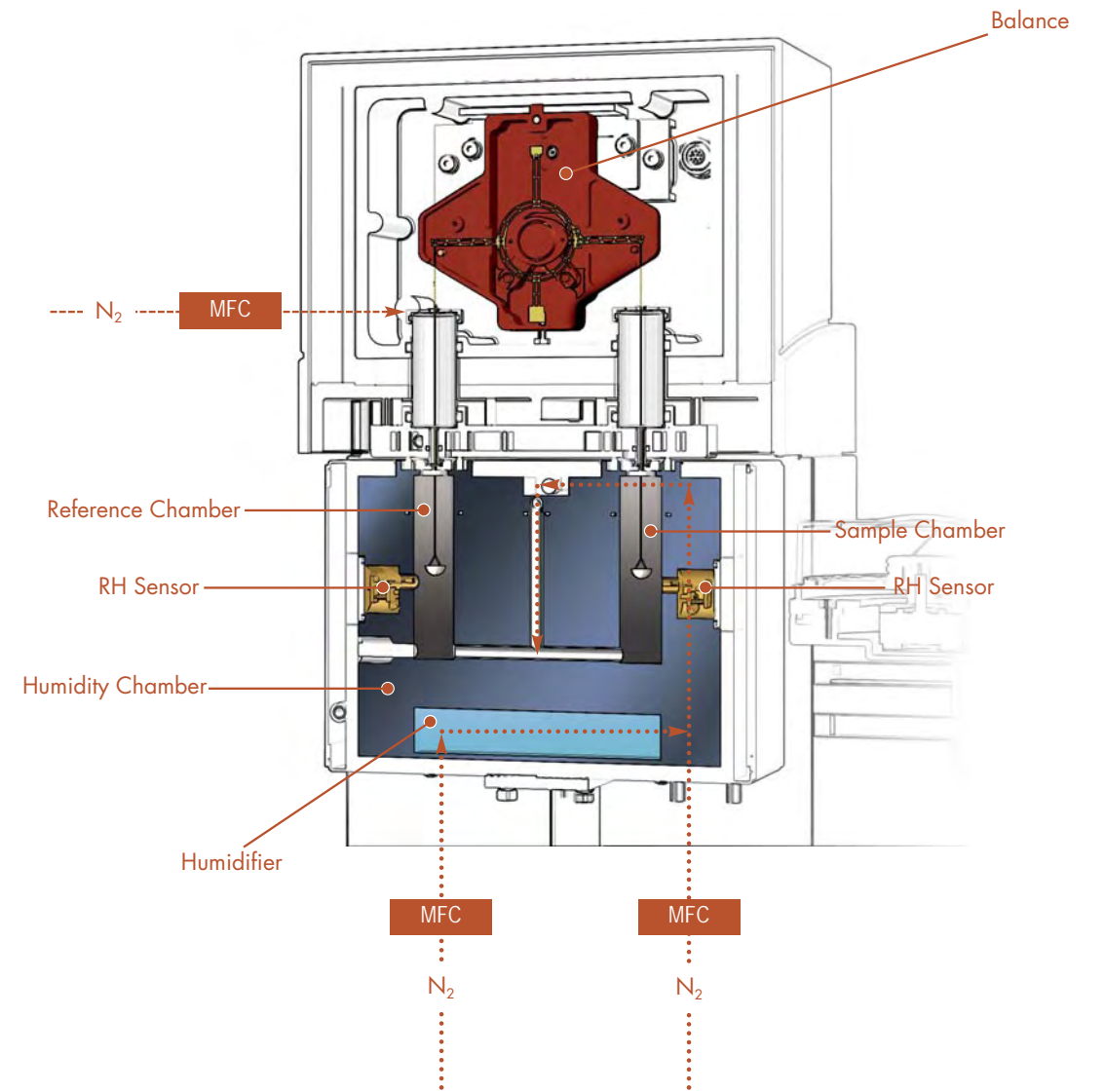

Q5000 SA TECHNOLOGY

The Q5000 SA is a compact, benchtop instrument that delivers the performance and reliability required in a leading sorption analyzer designed for the study of materials under controlled conditions of temperature and relative humidity. Its modern, user-friendly design features a high sensitivity, temperature-controlled thermobalance, an innovative humidity generation system, a 10-position autosampler, and our latest Advantage™ software with Platinum™ features.

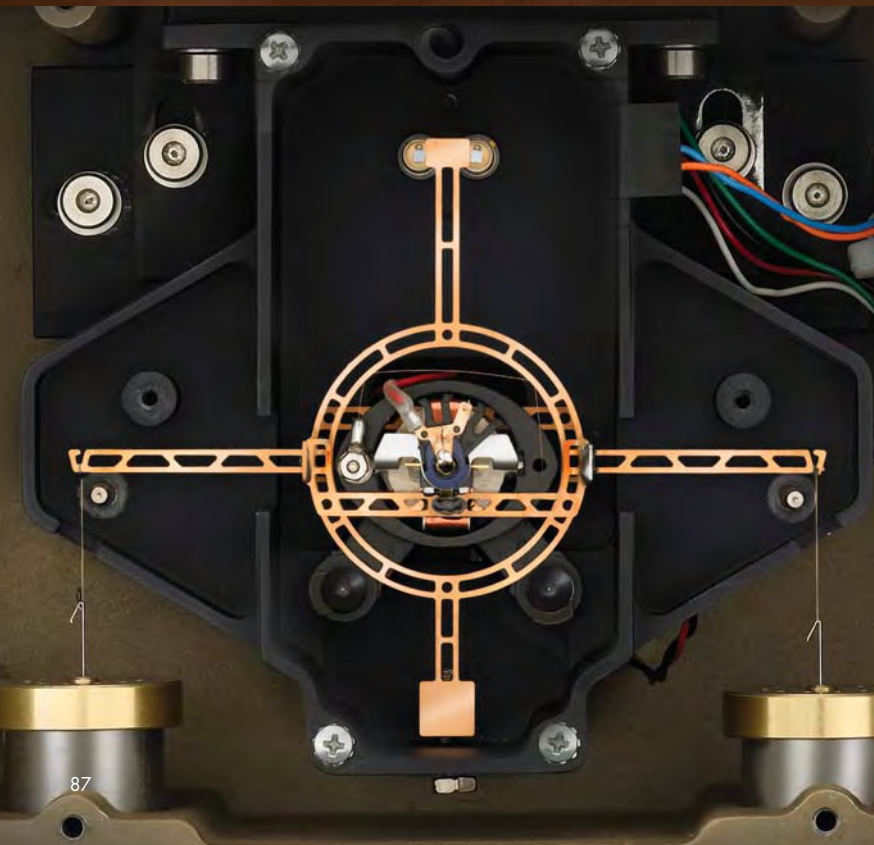

THERMOBALANCE

The heart of the Q5000 SA is our latest high performance thermobalance maintained at a constant 35.00 °C by three symmetrically arranged heaters in a well-insulated, gas-purged chamber. Isolated from the furnace by a water-cooled plate, the sensitive, null-balance design features the latest in precision weighing technology. A key feature of the design for sorption analysis operation is the perfect symmetry of the balance assembly. Customer benefits of the patented design include sensitive, reliable operation with superior baseline flatness and exceptional accuracy and precision in weight change detection; factors that are critical for proper gravimetric sorption analysis performance and are totally free from any vapor condensation or electrostatic forces.



AUTOSAMPLER

The integral Q5000 SA Autosampler features a programmable multi-position sample carousel that permits automated analysis of up to 10 samples using semi-spherical quartz (or metal-coated quartz) crucibles, and 25 samples using the optional Q5000 IR tray and platinum or sealed aluminum pans. The design provides smooth and efficient loading and unloading of the sample pan without disturbing the balance. All aspects of sample testing are automated and software controlled, including pan taring and loading, sample weighing, autosampler movement, furnace movement, pan unloading and furnace cooling. Autosampler productivity is maximized by our Advantage™ software, which provides pre-programmed analysis, comparison, and presentation of results.

GRAVIMETRIC VAPOR SORPTION ANALYSIS — GENERAL PRACTICE

Vapor Sorption analysis is an established technique for determining the effect on materials of exposure to controlled conditions of temperature and humidity. Isotherm and Isohume™ experiments are the most commonly performed analyses.

All TA Instruments sorption analyzers perform a range of essential sorption experiments, such as time-courses, isotherms (constant temperature, variable RH), and isohumidity (Isohume™) experiments (constant RH, variable temperature). Complex protocols with step changes in temperature and RH can be defined and saved for later use. Also, multiple experiments can be run sequentially without further operator assistance.

In isotherm experiments, a weighed sample is “dried” externally, or preferably in the instrument, and exposed to a series of humidity step changes at constant temperature. The sample is staged at each humidity level until no further weight change is detected or a set time has elapsed. A data point is recorded, the humidity is changed in 5 or 10% controlled RH steps and the process repeated in an increasing or decreasing procedure. Isohume experiments involve a series of temperature step changes at constant humidity and result in similar plots. They are used to determine how sample exposure to a given humidity results in a physiochemical change, such as a change in the sample’s hydration state. The curve shape provides useful information to this end.

TA Instruments analysis software offers Sorption Analysis, BET Analysis, and GAB programs. In addition, the full power and flexibility of our renowned Universal Analysis software provides for easy data manipulation, advanced reporting, plotting and file exporting capabilities. In addition, advanced data reduction of VTI-SA data can be performed using custom-designed data analyses packages. Analysis options include:

- Kinetic analysis for the determination of rate constant of adsorption
- Isosteric heat of adsorption using the Clausius-Clapeyron equation
- Surface area calculation using the BET equation for either water or organic vapors

SAMPLE CRUCIBLES

Semispherical metal-coated quartz crucibles (180 µL) and optional platinum (50 and 100 µL) TGA pans are available for use with the Q5000 SA. The former are commonly used in sorption analysis because of their anti-static capabilities, chemical inertness and ease of cleaning, while Platinum pans are generic for TGA analysis of most materials. Sealed aluminum pans are also an option for ensuring the integrity of materials which readily adsorb moisture or lose volatiles.



APPLICATIONS

EVALUATION OF AMORPHOUS STRUCTURE

Pharmaceutical scientists are often interested in determining the amount of amorphous material in a drug formulation. As the amorphous and crystalline forms are chemically identical, classical analysis techniques are often insensitive to amorphous content. The figure below shows the moisture sorption analysis of a generic drug in its amorphous and crystalline forms. As the amorphous form absorbs significantly more water, the Q5000 SA can be used to quantify relative amorphous content in drug mixtures.

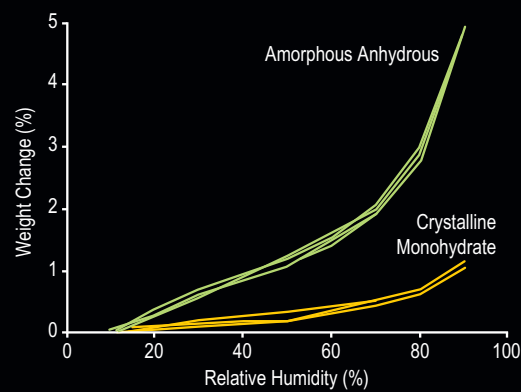

ANALYZING SMALL AMOUNTS OF PHARMACEUTICALS

When evaluating pharmaceuticals it is common for only small amounts of material to be available for conducting multiple analytical tests. Hence, the ability to work with small samples is critical. The low baseline drift of the Q5000 SA means that good results can be obtained on even 10-20 milligrams of a crystalline drug, such as prednisone, which adsorbs <0.1% moisture over a broad humidity range. The sorption results shown below represent about 15 micrograms of weight change full-scale. The reversibility (lack of hysteresis) in the sorption/desorption profile for prednisone (as well as the low level of moisture adsorbed) indicates that the moisture picked up by the material is adsorbed on the surface of the material rather than being absorbed into its structure.

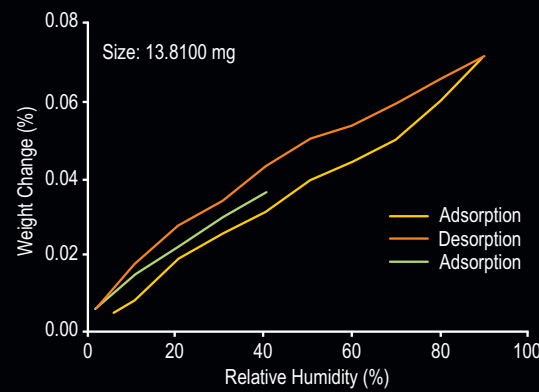

HYDRATE FORMATION

The figure below contains the experimental results demonstrating the formation of a hydrate. The hydrate formation is characterized by a plateau in the desorption branch of the isotherm. In this example the hydrate is formed at around 45% RH. The sample adsorbs about 4.5% by weight water and does not lose the water of hydration until the RH is lowered below 25%. This hydrate would be considered as a labile or unstable hydrate.

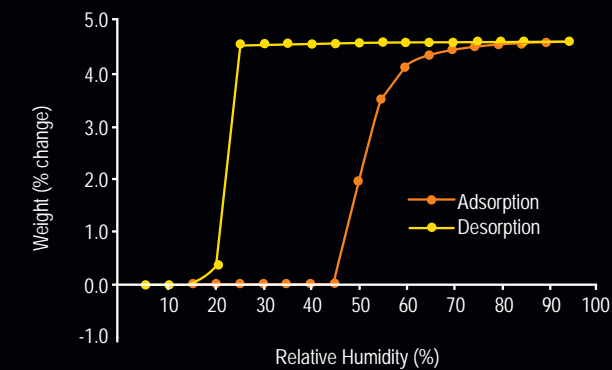

CHARACTERIZATION OF MORPHOLOGICAL STABILITY

Exposure to elevated humidity can initiate morphological changes in some pharmaceutical materials, particularly in amorphous sugars. As the humidity is increased, the adsorbed water plasticizes the material and lowers the glass transition. When the glass transition temperature decreases to the experimental temperature, crystallization will typically occur. The data in the figure below show the behavior of amorphous lactose at 25°C, under a constant increase in humidity. Note how the character in the measured weight signal is indicative of a variety of morphological changes, including the glass transition, and subsequent crystallization of the amorphous phase.

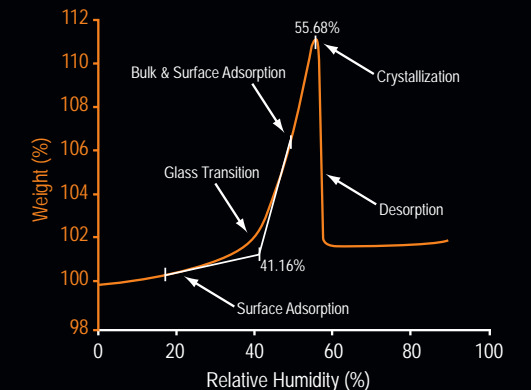

APPLICATIONS

SAMPLE THROUGHPUT: VTI-SA3

The VTI-SA3 is designed to provide high sample throughput without sacrificing data quality, accuracy or reproducibility. The figure below contains the data from three polyvinylpyrrolidone (PVP) samples which were analyzed simultaneously on the VTI-SA3. The samples were initially dried at 25°C and 0% RH, and the data are initially normalized to 0% weight change. The relative humidity was then increased initially to 10%, then to 60% and finally 80% RH. The resultant data demonstrates the reproducibility of the simultaneous, continuous measurements. The inset table contains the quantified weight change at each equilibrium, and confirms the reproducibility of measured data.

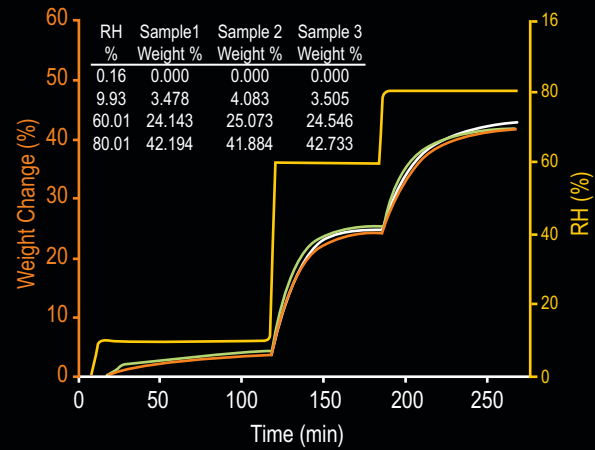

ORGANIC VAPOR SORPTION (VTI-SA)

With the organic vapor sorption capability, the VTI-SA can obtain not only water sorption isotherms, but can also be used to generate organic vapor isotherms. The use of organic vapor increases the sensitivity of the sorption measurement for many pharmaceutical and polymer materials. The figure below contains the sorption isotherm for α -amylase with ethanol at 25°C.

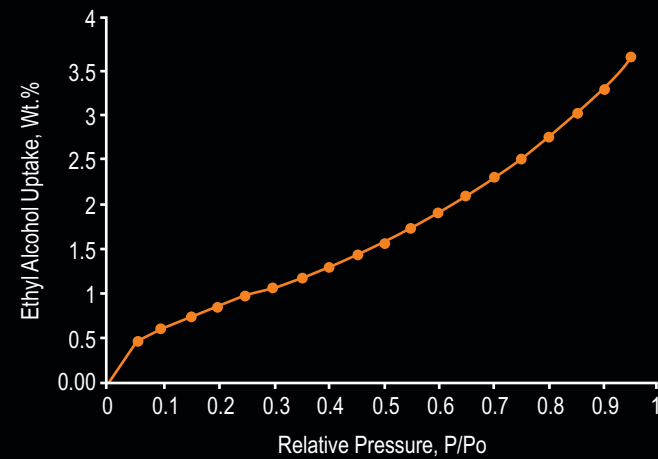

PACKAGING FILM ANALYSIS

In addition to evaluation of the actual pharmaceutical formulations, sorption analysis can also be valuable in comparing the polymeric films which are being considered for packaging the drugs and other materials. The figure below shows comparative profiles for two different packaging materials undergoing temperature and relative humidity cycling. Film A adsorbs and desorbs moisture at a more rapid rate than the other film evaluated which suggests it may not be suitable for packaging moisture sensitive compounds.

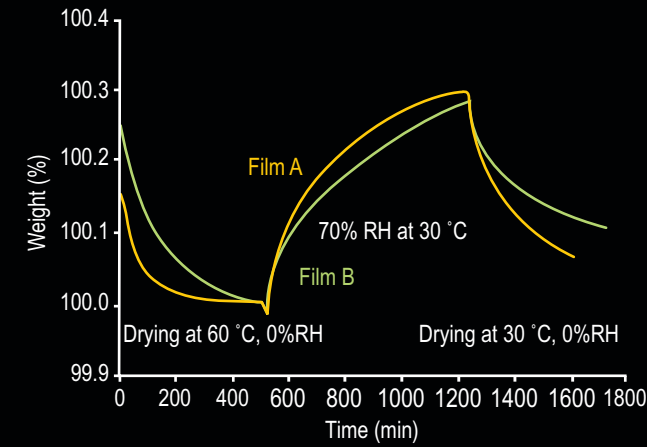

RATE OF DIFFUSION

The VTI-SA can be equipped with a diffusion cell which allows for the direct measurement of the permeability of a film or membrane for a particular solvent vapor. The cell consists of a cavity that is filled either with a desiccant or absorber, a gasketed lid for attaching the film to be tested and a wire stirrup to hang the assembled cell on the hang-down wire of the balance. Any vapor permeating through the film gets adsorbed immediately and the weight of the cell will increase until steady-state conditions are reached. The normalized rate of permeation is obtained from the slope of this line (weight per unit time) and the diameter of the permeating film.

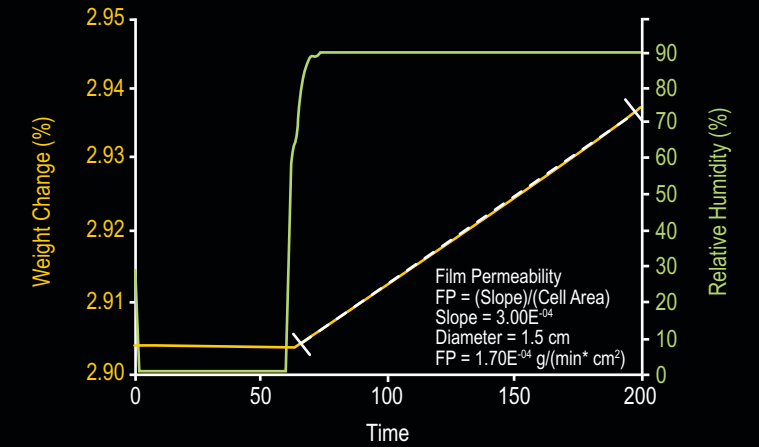

DMA
Q800



Dynamic Mechanical Analysis

Q800



TECHNICAL SPECIFICATIONS

Maximum Force	18 N
Minimum Force	0.0001 N
Force Resolution	0.00001 N
Strain Resolution	1 nanometer
Modulus Range	10^3 to 3×10^{12} Pa
Modulus Precision	$\pm 1\%$
Tan δ Sensitivity	0.0001
Tan δ Resolution	0.00001
Frequency Range	0.01 to 200 Hz
Dynamic Sample Deformation Range	± 0.5 to 10,000 μm
Temperature Range	-150 to 600 °C
Heating Rate	0.1 to 20 °C/min
Cooling Rate	0.1 to 10 °C/min
Isothermal Stability	± 0.1 °C
Time/Temperature Superposition	Yes

OUTPUT VALUES

Storage Modulus	Complex/Dynamic Viscosity	Time
Loss Modulus	Creep Compliance	Stress/Strain
Storage/Loss Compliance	Relaxation Modulus	Frequency
Tan Delta (δ)	Static/Dynamic Force	Sample Stiffness
Complex Modulus	Temperature	Displacement

The Q800 is the world's best-selling DMA, for very good reasons. It utilizes state-of-the-art, non-contact, linear drive technology to provide precise control of stress, and air bearings for low friction support. Strain is measured using optical encoder technology that provides unmatched sensitivity and resolution. With its unique design, the Q800 easily outperforms competitive instruments, and is ideal for high-stiffness applications including composites.

DEFORMATION MODES & SAMPLE SIZE

INSTRUMENT/CLAMP	SAMPLE SIZE
DUAL/SINGLE CANTILEVER	
	8/4** mm (L), Up to 15 mm (W) and 5 mm (T)
	20/10** mm (L), Up to 15 mm (W) and 5 mm (T)
	35/17.5** mm (L), Up to 15 mm (W) and 5 mm (T)
3-POINT BEND	
	5, 10, or 15 mm (L), Up to 15 mm (W) and 7 mm (T)
	20 mm (L), Up to 15 mm (W) and 7 mm (T)
	50 mm (L), Up to 15 mm (W) and 7 mm (T)
TENSION	
Film/Fiber	5 to 30 mm (L), Up to 8 mm (W) and 2 mm (T)
Fiber	5 to 30 mm (L), 5 denier (0.57 tex) to 0.8 mm diameter
SHEAR	
	10 mm square, Up to 4 mm (T)
COMPRESSION	
	15 and 40 mm diameter, Up to 10 mm (T)
SUBMERSSION	
Tension	5 to 30 mm (L), Up to 8 mm (W) and 2 mm (T)
Compression	15 and 40 mm diameter, Up to 10 mm (T)
3-Point Bend	5, 10, or 15 mm (L), Up to 15 mm (W) and 7 mm (T)

**Lengths are for dual/single cantilever

MODES OF OPERATION

MULTI-FREQUENCY

The multi-frequency mode can assess viscoelastic properties as a function of frequency, while oscillation amplitude is held constant. These tests can be run at single or multiple frequencies, in time sweep, temperature ramp, or temperature step/hold experiments.

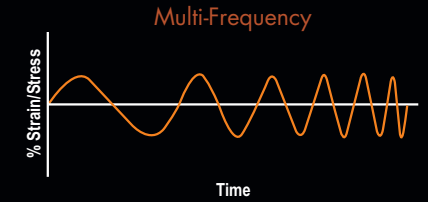

MULTI-STRESS/STRAIN

In this mode, frequency and temperature are held constant, and the viscoelastic properties are monitored as strain or stress is varied. This mode is primarily used to identify the Linear Viscoelastic Range (LVR).



CREEP/STRESS RELAXATION

With creep, the stress is held constant and deformation is monitored as a function of time. In stress relaxation, the strain is held constant and the stress is monitored vs. time.

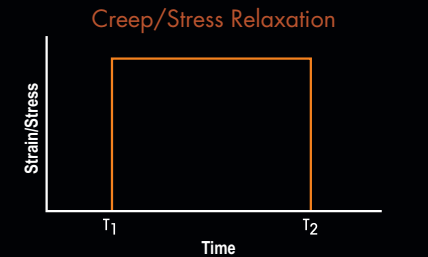

CONTROLLED FORCE/STRAIN RATE

In this mode, the temperature is held constant while stress or strain is ramped at a constant rate. This mode is used to generate stress / strain plots to obtain Young's Modulus. Alternatively, stress can be held constant with a temperature ramp while strain is monitored.

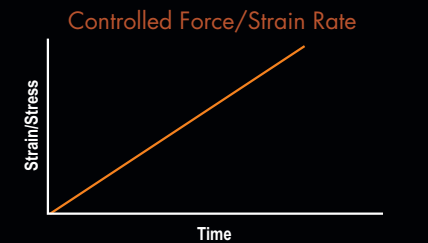

ISO STRAIN

In isostrain mode, available on the Q800, strain is held constant during a temperature ramp. Isostrain can be used to assess shrinkage force in films and fibers.

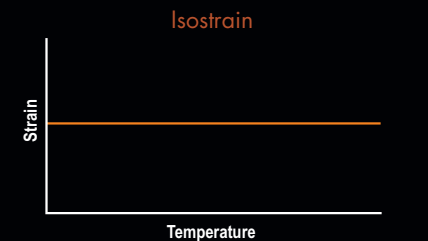

Q800 TECHNOLOGY

DRIVE MOTOR

The Q800 uses a non-contact, direct drive motor to provide the oscillatory or static force required. The motor is constructed of high performance composites that ensure low compliance and is thermostated to eliminate heat build-up even when using large oscillation amplitudes and high deformation forces. Sophisticated electronics enable the motor current to be rapidly adjusted in small increments. The motor can deliver reproducible forces over a wide range and the force can be changed rapidly, enabling a broad spectrum of material properties to be measured.

AIR BEARINGS

The non-contact drive motor transmits force directly to a rectangular air bearing slide. The slide is guided by eight porous carbon air bearings grouped into two sets of four near the top and bottom of the slide. Pressurized air or nitrogen flows to the bearings forming a frictionless surface that permits the slide to "float." The slide, which connects to the drive shaft and sample clamp, can move vertically 25 mm and its rectangular shape eliminates any twisting of the sample. Very weak materials like films and fibers can be characterized with ease.

OPTICAL ENCODER

A high-resolution linear optical encoder is used to measure displacement on the Q800 DMA. Based on diffraction patterns of light through gratings (one moveable and one stationary), optical encoders provide exceptional resolution compared to typical LVDT technology. Due to the excellent 1 nanometer resolution of the optical encoder, very small amplitudes can be measured precisely. This combined with the non-contact drive motor and air bearing technology provides excellent modulus precision and high $\tan \delta$ sensitivity, allowing the Q800 DMA to characterize a broad range of materials.

FURNACE

The Q800 features a bifilar wound furnace with automated movement. The furnace design combined with the Gas Cooling Accessory provides for efficient and precise temperature control over the entire temperature range, both in heating, cooling, and isothermal operation. The automatic furnace movement simplifies experimental setup.

LOW MASS, HIGH STIFFNESS SAMPLE CLAMPS

The Q800 features a variety of sample clamps that provide for multiple modes of deformation. The clamps are optimized using finite element analysis to provide high stiffness, with low mass, and attach to the drive shaft with a simple dovetail connection. The clamps are easy to use and adjust, and each is individually calibrated to insure data accuracy. A broad range of samples can be analyzed. The high stiffness minimizes clamp compliance, and the low mass ensures rapid temperature equilibration. These simple, yet elegant designs reduce the time necessary to change clamps and load samples.

RIGID ALUMINUM CASTING

The Q800 drive motor, air bearing slide assembly with optical encoder and air bearings are all mounted within a rigid aluminum casting that is temperature controlled. The rigid aluminum housing minimizes system compliance and the temperature-controlled housing ensures precise data.

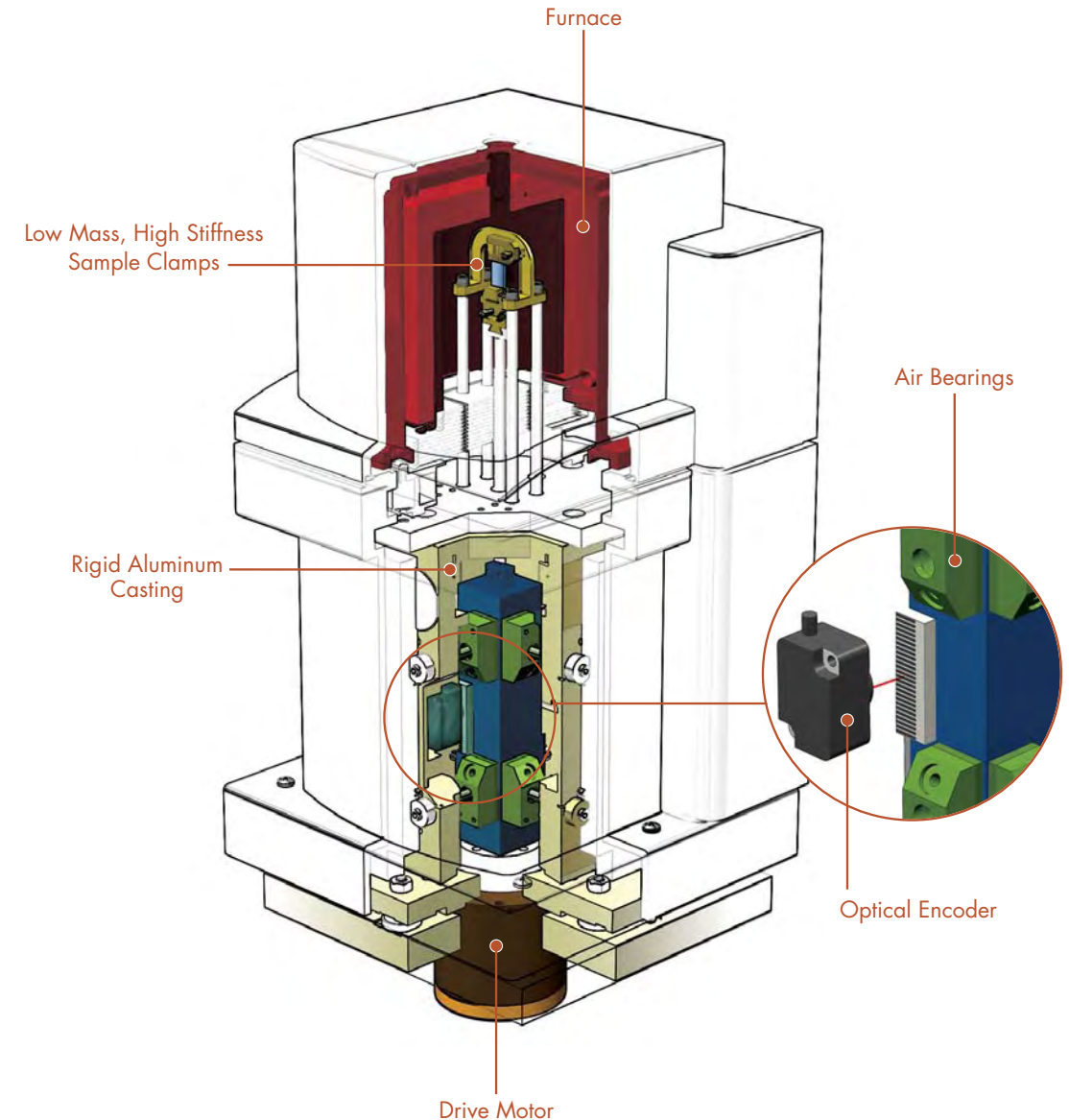

MODES OF DEFORMATION

DUAL/SINGLE CANTILEVER

In this mode, the sample is clamped at both ends and either flexed in the middle (dual cantilever) or at one end (single cantilever). Cantilever bending is a good general-purpose mode for evaluating thermoplastics and highly damped materials (e.g., elastomers). Dual cantilever mode is ideal for studying the cure of supported thermosets. A powder clamp is also available for characterizing transitions in powder materials.



3-POINT BEND

In this mode, the sample is supported at both ends and force is applied in the middle. 3-point bend is considered a “pure” mode of deformation since clamping effects are eliminated. The 50 and 20 mm clamps on the Q800 utilize unique low-friction, roller bearing supports that improve accuracy.



SHEAR SANDWICH

In this mode, two equal-size pieces of the same material are sheared between a fixed and moveable plate. This mode is ideal for gels, adhesives, high viscosity resins, and other highly damped materials.



COMPRESSION

In this mode, the sample is placed on a fixed flat surface and an oscillating plate applies force. Compression is suitable for low to moderate modulus materials (e.g., foams and elastomers). This mode can also be used to make measurements of expansion or contraction, and tack testing for adhesives.



TENSION

In this mode, the sample is placed in tension between a fixed and moveable clamp. In oscillation experiments, the instruments use a variety of methods for applying a static load to prevent buckling and unnecessary creep. The clamps are suitable for both films and fibers.



SUBMERSIBLE CLAMPS

Film tension, compression, and 3-point bend clamps are available in submersible configurations for the Q800. These clamps allow samples to be analyzed in a fluid environment up to 80 °C.



ACCESSORIES

SUBAMBIENT OPERATION

The Gas Cooling Accessory (GCA) extends the operating range of the Q800 to -150 °C. The GCA uses cold nitrogen gas generated from controlled evaporation of liquid nitrogen. Automated filling of the GCA tank can be programmed to occur after the scan is complete.



DMA THEORY



Dynamic Mechanical Analysis (DMA) is a technique used to measure the mechanical properties of a wide range of materials. Many materials, including polymers, behave both like an elastic solid and a viscous fluid, thus the term viscoelastic. DMA differs from other mechanical testing devices in two important ways. First, typical tensile test devices focus only on the elastic component. In many applications, the inelastic, or viscous component, is critical. It is the viscous component that determines properties such as impact resistance. Second, tensile test devices work primarily outside the linear viscoelastic range. DMA works primarily in the linear viscoelastic range and is therefore more sensitive to structure.

DMA measures the viscoelastic properties using either transient or dynamic oscillatory tests. Transient tests include creep and stress relaxation. In creep, a stress is applied to the sample and held constant while deformation is measured vs. time. After some time, the stress is removed and the recovery is measured. In stress relaxation, a deformation is applied to the sample and held constant, and the degradation of the stress required to maintain the deformation is measured versus time.

The most common test is the dynamic oscillatory test, where a sinusoidal stress (or strain) is applied to the material and a resultant sinusoidal strain (or stress) is measured (Figure 1). Also measured is the phase difference, δ , between the two sine waves. The phase lag will be 0° for purely elastic materials and 90° for purely viscous materials. Viscoelastic materials (e.g. polymers) will exhibit an intermediate phase difference.

Since modulus equals stress/strain, the complex modulus, E^* , can be calculated. From E^* and the measurement of δ , the storage modulus, E' , and loss modulus, E'' , can be calculated as illustrated in Figure 2. The storage modulus (E') is the elastic component and related to the sample's stiffness. The loss modulus (E'') is the viscous component and is related to the sample's ability to dissipate mechanical energy through molecular motion. The tangent of phase difference, or $\tan \delta$, is another common parameter that provides information on the relationship between the elastic and inelastic components. All of these parameters can be calculated as a function of time, temperature, frequency, or amplitude (stress or strain) depending on the application.

Figure 1

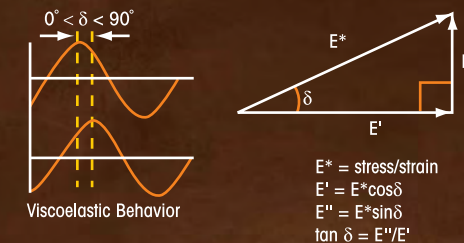
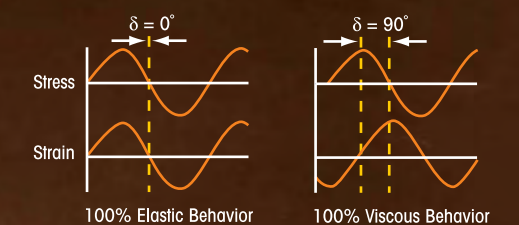

Figure 2



APPLICATIONS

MEASUREMENT OF T_g OF POLYMERIC MATERIALS

A common measurement on polymers is the glass transition temperature, T_g. It can be measured with various techniques, but DMA is by far the most sensitive. The figure below shows a scan of a pressure sensitive adhesive run in the tension clamps at a frequency of 1 Hz. T_g can be measured by the E' onset point, by the E'' peak, or the peak of Tan δ. In addition to the T_g, the absolute value of the various viscoelastic parameters is also useful.

FREQUENCY EFFECT ON MODULUS AND GLASS TRANSITION OF POLYETHYLENE TEREPHTHALATE (PET)

Because the T_g has a kinetic component, it is strongly influenced by the frequency (rate) of deformation. As the frequency of the test increases, the molecular relaxations can only occur at higher temperatures and, as a consequence, the T_g will increase with increasing frequency as illustrated below. In addition, the shape and intensity of the Tan δ peak as well as the slope of the storage modulus in the transition region will be affected. Based on end-use conditions, it is important to understand the temperature and frequency dependence of transitions.

THE MEASUREMENT OF SECONDARY TRANSITIONS IN VINYL ESTER

DMA is one of the few techniques sensitive to β and γ secondary transitions. Secondary transitions arise from side group motion with some cooperative vibrations from the main chain as well as internal rotation within a side group. The transitions are below the T_g and typically subambient. They are very important as they affect impact resistance and other end-use properties. This data was generated using 3-point bending and also illustrates the ability to run stiff composites.

MEASURING EFFECT OF ADHESIVE COATINGS ON FILMS

The figure below shows a comparison among three PET samples in tension on the DMA: one with a uniform adhesive layer that performs well; one with a non-uniform layer that performs poorly; and one that is uncoated. A transition peak due to the adhesive is seen in Tan δ around 40 °C in the "good" sample, whereas the "poor" sample shows a much smaller peak. Knowing the characteristics of good and poor samples enables quality control of the coating process and the finished product.

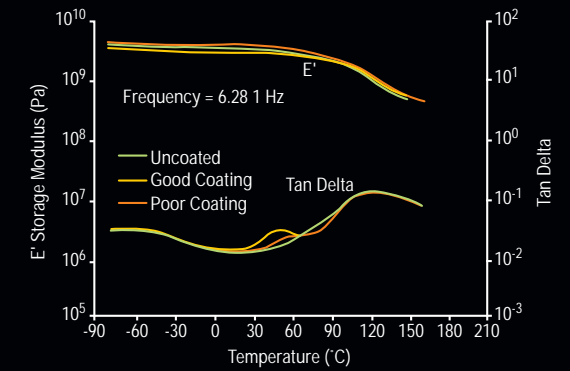
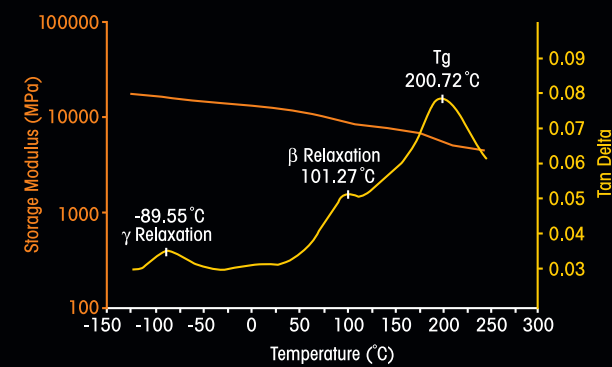
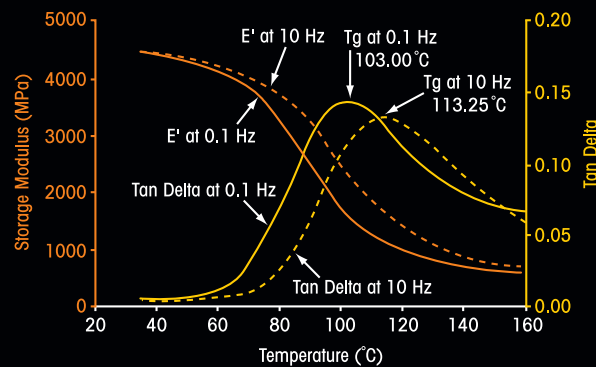
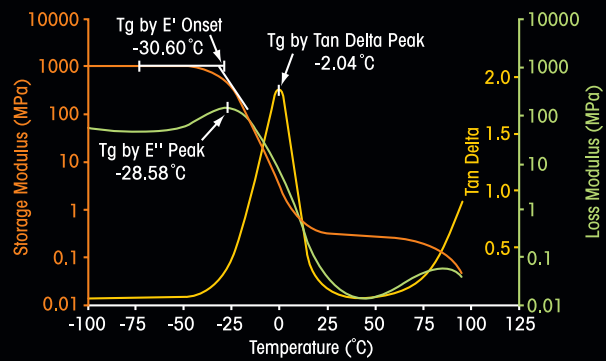

APPLICATIONS

CHARACTERIZING PRINTED CIRCUIT BOARDS

Printed Circuit Boards (PCB) are typically comprised of fiberglass braid impregnated with a thermosetting resin. Characterizing the Tg of PCB's is often difficult due to the very low amount of resin used. The figure below shows a typical PCB run in single cantilever bending. The Tg is clearly discernible and the difference between the sample "as received" and "post baked" clearly shows the effect that further crosslinking has on both the Tg and the absolute value of modulus.

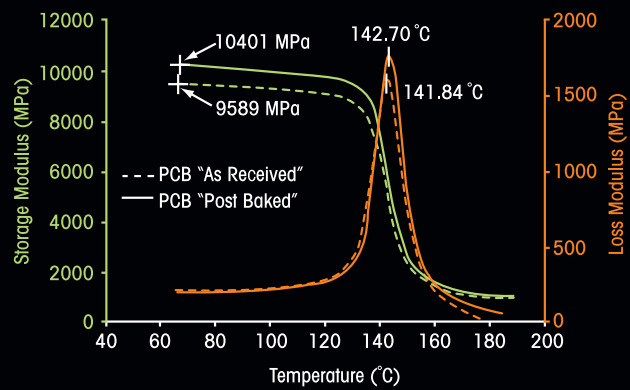

EFFECT OF CARBON BLACK IN ELASTOMERS

Another very common application is the effect of fillers and additives on viscoelastic properties. The figure below illustrates the effect on storage modulus (E') and Tan δ when adding carbon black to an SBR rubber. This test, performed in dual cantilever on the DMA, shows that adding carbon black increases the absolute value of the storage modulus and significantly increases the Tg temperature. Understanding how fillers and additives affect material properties is crucial in many industrial applications.

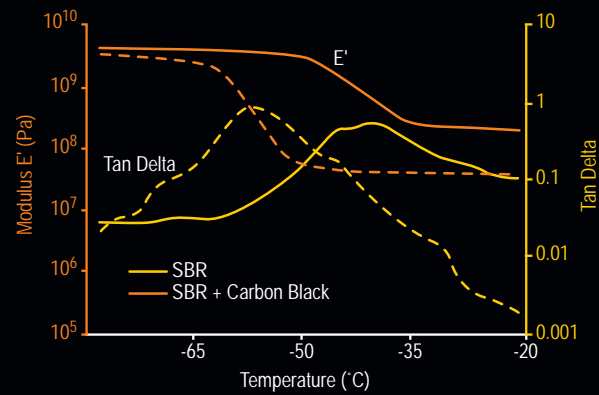

CHARACTERIZING PACKAGING FILMS USING CREEP

In a thermoforming process, a film is pulled down into a heated mold to form a desired shape. The ability to produce a stable product can be predicted by using a creep-recovery experiment. Below illustrates data on a packaging film using the tension mode. In the recovery phase, the equilibrium recoverable compliance, (J_{er}) can be calculated. If the sample compliance is too high, as observed by a high J_{er}, then the elasticity may be too low at the forming temperature to maintain the desired shape.

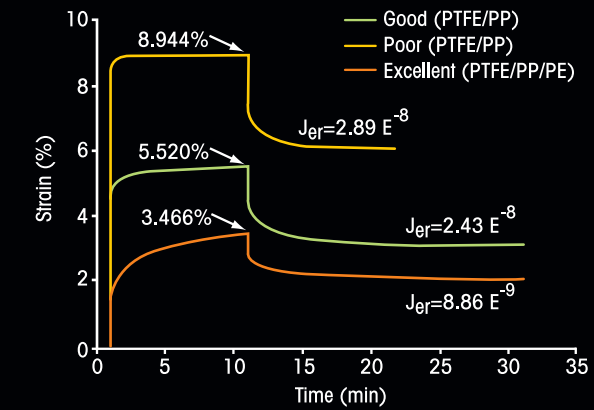

PREDICTING MATERIAL PERFORMANCE USING TIME / TEMPERATURE SUPERPOSITIONING (TTS)

The TTS technique, well-grounded in theory, is used to predict material performance at frequencies or time scales outside the range of the instrument. Data is usually generated by scanning multiple frequencies during a series of isothermal step-hold experiments over a temperature range. A reference temperature is selected and the data shifted. A shift factor plot is generated and fit to either a Williams-Landel-Ferry (WLF) or Arrhenius model. Finally, a master curve at a specific temperature is generated as illustrated below for a PET film sample. Using this technique, properties at very high frequencies (short time scales) or very low frequencies (long time scales) can be assessed.

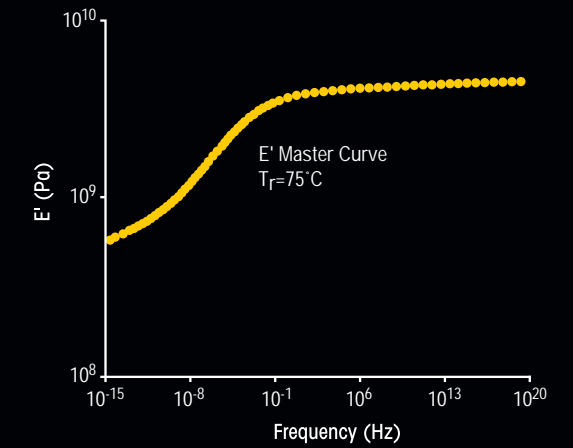

TMA
Q400



Thermomechanical Analysis

Q400EM/Q400



The Q400EM is the industry's leading research-grade thermomechanical analyzer, with unmatched flexibility in operating modes, test probes and available signals. The Enhanced Mode (EM) allows for additional transient (stress / strain), dynamic and Modulated TMA™ experiments that provide for more complete viscoelastic materials characterization plus a way to resolve overlapping thermal events (MTMA)

The Q400 delivers the same basic performance and reliability as the Q400EM but without the latter's advanced EM features. It is ideal for research, quality control and teaching applications.

TECHNICAL SPECIFICATIONS

	Q400EM	Q400
Temperature Range (max)	-150 to 1,000 °C	-150 to 1,000 °C
Temperature Precision	± 1 °C	± 1 °C
Furnace Cool Down Time (air cooling)	<10 min from 600 °C to 50 °C	<10 min from 600 °C to 50 °C
Maximum Sample Size - solid	26 mm (L) x 10 mm (D)	26 mm (L) x 10 mm (D)
Maximum Sample Size - film/fiber		
Static Operation	26 mm (L) x 1.0 mm (T) x 4.7 mm (W)	26 mm (L) x 1.0 mm (T) x 4.7 mm (W)
Dynamic Operation	26 mm (L) x .35 mm (T) x 4.7 mm (W)	Not Included
Measurement Precision	± 0.1 %	± 0.1 %
Sensitivity	15 nm	15 nm
Displacement Resolution	<0.5 nm	<0.5 nm
Dynamic Baseline Drift	<1 µm (-100 to 500 °C)	<1 µm (-100 to 500 °C)
Force Range	0.001 to 2 N	0.001 to 2 N
Force Resolution	0.001 N	0.001 N
Frequency Range	0.01 to 2 Hz	Not Included
Mass Flow Control	Included	Included
Atmosphere (static or controlled flow)	Inert, Oxidizing, or Reactive Gases	Inert, Oxidizing, or Reactive Gases

OPERATIONAL MODES

	Q400EM	Q400
Standard	Included	Included
Stress/Strain	Included	—
Creep	Included	—
Stress Relaxation	Included	—
Dynamic TMA (DTMA)	Included	—
Modulated TMA™ (MTMA™)	Included	—

Note: The Q400 can be field upgraded to the Q400EM.

Q400 TECHNOLOGY

A thermomechanical analyzer measures sample dimensional changes under conditions of controlled temperature, time, force, and atmosphere. Our engineering experience in design and integration of critical furnace, temperature, dimension measurement, and atmosphere-control components meld with powerful, flexible software to optimize the numerous tests available which the Q Series™ TMA can perform.

FURNACE

The Q400 vertical furnace is designed for high performance, ease-of-use, reliability and long life in a wide variety of applications. Customized electronics provide the temperature control and response required for superior baselines, enhanced sensitivity and Modulated TMA™ operation. Software control of the furnace movement ensures operational convenience and simplified sample loading / unloading. The Inconel® 718 Dewar atop the furnace allows continuous operation in cyclic heating / cooling studies using the new optional mechanical cooling accessory (MCA 70).

SAMPLE CHAMBER

The easily accessible chamber provides complete temperature and atmosphere control required for generation of high quality TMA data. The design simplifies installation of the available probes (See Modes of Deformation), sample mounting and thermocouple placement. An integral digital mass flow controller meters the flow of purge gas to the sample area. Precise and responsive temperature control and the well-regulated purge gas result in optimized performance in the standard and MTMA modes of operation. The design benefits also include flexibility in operation and ease of use.

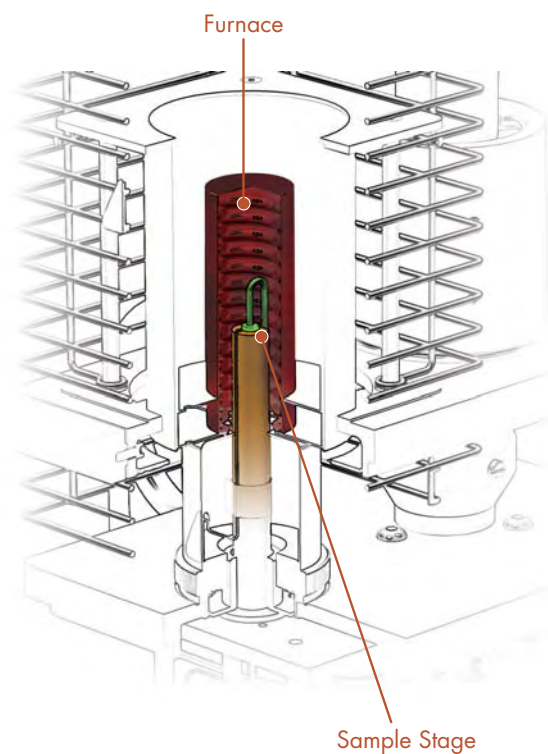

LINEAR VARIABLE DIFFERENTIAL TRANSDUCER

The heart of the Q400 TMA sample measurement system is the precision, moveable-core, linear variable differential transducer (LVDT), which generates an accurate output signal that is directly proportional to a sample dimension change. Its precise and reliable response over a wide temperature range (-150 to 1,000 °C) ensures reproducible TMA results. Its location below the furnace protects it from temperature effects and ensures stable baseline performance.

FORCE MOTOR

A non-contact motor provides a controlled, friction-free, calibrated force to the sample via a probe or fixture. The force is digitally programmed from 0.001 to 1N, and can be increased manually to 2 N by addition of weights. The motor precisely generates the static, ramped or oscillatory dynamic forces necessary for quality measurements in all deformation modes. Ten individual frequencies are available for optimizing data quality in dynamic TMA experiments in compression, 3-point bending or tension modes of deformation.

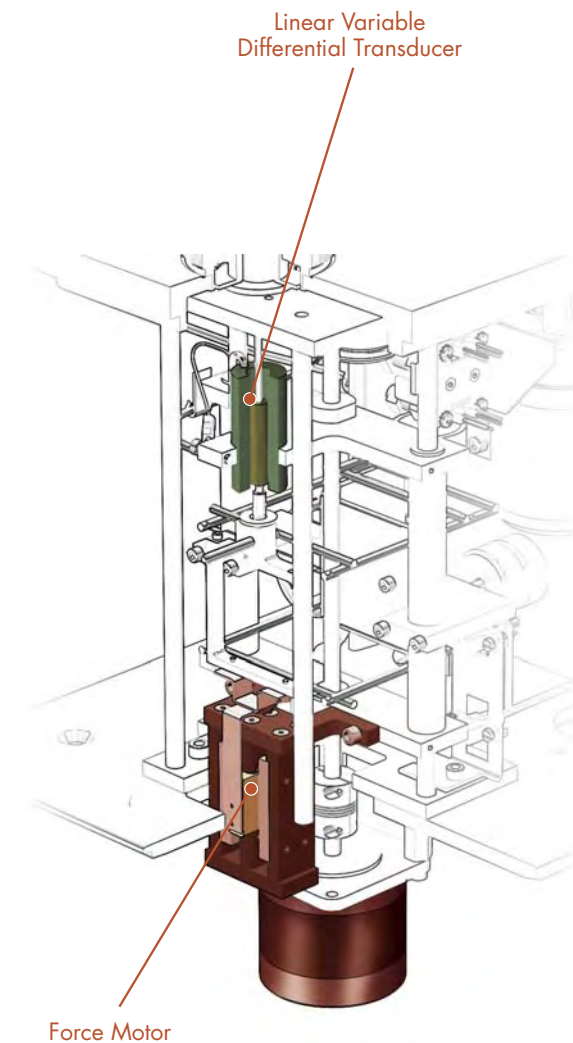

MODES OF DEFORMATION

The Q400 offers all the major TMA deformation modes necessary to characterize a wide range of materials such as solids, foams, films, and fibers. These include expansion, penetration, compression, tension, and 3-point bending.

EXPANSION

Expansion measurements determine a material's coefficient of thermal expansion (CTE), glass transition temperature (T_g), and compression modulus. A flat-tipped standard expansion probe is placed on the sample (a small static force may be applied), and the sample is subjected to a temperature program. Probe movement records sample expansion or contraction. This mode is used with most solid samples. The larger surface area of the macro-expansion probe facilitates analysis of soft or irregular samples, powders, and films.

PENETRATION

Penetration measurements use an extended tip probe to focus the drive force on a small area of the sample surface. This provides precise measurement of glass transition (T_g), softening, and melting behavior. It is valuable for characterizing coatings without their removal from a substrate. The probe operates like the expansion probe, but under a larger applied stress. The hemispherical probe is an alternate penetration probe for softening point measurements in solids.



Expansion

Macro-Expansion

Penetration

Hemispherical

TENSION

Tensile studies of the stress/strain properties of films and fibers are performed using a film/fiber probe assembly. An alignment fixture permits secure and reproducible sample positioning in the clamps. Application of a fixed force is used to generate stress/strain and modulus information. Additional measurements include shrinkage force, T_g , softening temperatures, cure, and cross-link density. Dynamic tests (e.g. DTMA, MTMA™) in tension can be performed to determine viscoelastic parameters (e.g., E' , E'' , $\tan \delta$), and to separate overlapping transitions.

COMPRESSION

In this mode, the sample is subjected to either a static, linear ramp, or dynamic oscillatory force, while under a defined temperature program and atmosphere. Sample displacement (strain) is recorded by either expansion/penetration experiments and used to measure intrinsic material properties, or by dynamic tests and used to determine viscoelastic parameters (DTMA), detect thermal events, and separate overlapping transitions (MTMA).

3-POINT BENDING

In this bending deformation (also known as flexure), the sample is supported at both ends on a two-point, quartz anvil atop the stage. A fixed static force is applied vertically to the sample at its center, via a wedge-shaped, quartz probe. This mode is considered to represent "pure" deformation, since clamping effects are eliminated. It is primarily used to determine bending properties of stiff materials (e.g., composites), and for distortion temperature measurements. Dynamic (DTMA) measurements are also available with the Q400EM, where a special, low-friction, metallic anvil replaces the quartz version.

SPECIALTY PROBE/FIXTURE KITS

Additional sample measurement probes and fixtures are available for use with both the Q400 and Q400EM in specialty TMA applications. These include the following:

Dilatometer Probe Kit – for use in volume expansion coefficient measurements

Parallel Plate Rheometer – for the measurement of low shear viscosity of materials (10 to 10^7 Pa.s range) under a fixed static force

The expansion, macro-expansion, and penetration probes are supplied with the Q400. These probes, plus the flexure probe, and the low-friction bending fixture, are included with the Q400EM module. Data analysis programs relevant to each of the measurements described are provided in our Advantage™ software.



Tension



3-Point Bending

TMA THEORY / MODES OF OPERATION

TMA measures material deformation changes under controlled conditions of force, atmosphere, time and temperature. Force can be applied in compression, flexure, or tensile modes of deformation using specially designed probes described in pages 117-118. TMA measures intrinsic material properties (e.g., expansion coefficient, glass transition, Young's modulus), plus processing/product performance parameters (e.g., softening points). These measurements have wide applicability, and can be performed by either the Q400 or the Q400EM. The Q400 and Q400EM operating modes permit multiple material property measurements. The Q400 features the Standard mode, while the Q400EM additionally offers Stress / Strain, Creep, Stress Relaxation, Dynamic TMA and Modulated™ TMA modes as described below.

STANDARD MODE (Q400/Q400EM)

Temperature Ramp: Force is held constant, and displacement is monitored under a linear temperature ramp to provide intrinsic property measurements. Isostrain (shrinkage force): Strain is held constant, and the force required to maintain the strain is monitored under a temperature ramp. This permits assessment of shrinkage forces in materials such as films / fibers. Force Ramp: Force is ramped, and resulting strain is measured at constant temperature to generate force / displacement plots and modulus assessment.

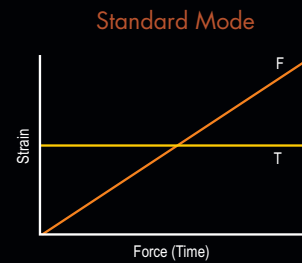
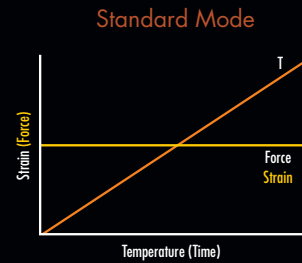

STRESS/STRAIN MODE (Q400EM)

Stress or strain is ramped, and the resulting strain or stress is measured at constant temperature. Using customer-entered sample geometry factors, the data provides both stress / strain plots and related modulus information. In addition, calculated modulus can be displayed as a function of stress, strain, temperature, or time.

Stress/Strain Mode (Q400EM)

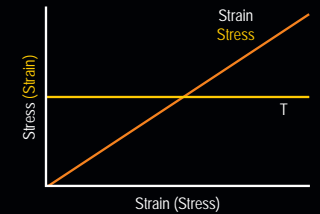

CREEP AND STRESS RELAXATION (Q400EM)

TMA can also measure viscoelastic properties using transient (creep or stress relaxation) tests. These require the Q400EM module. In a creep experiment, input stress is held constant, and resulting strain is monitored as a function of time. In a stress relaxation experiment, input strain is held constant, and stress decay is measured as a function of time. The data can also be displayed in units of compliance (creep mode) and stress relaxation modulus (stress relaxation mode).

Creep And Stress Relaxation (Q400EM)

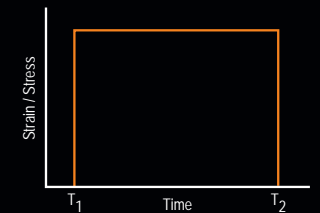

DYNAMIC TMA MODE (Q400EM)

In Dynamic TMA (DTMA), a sinusoidal force and linear temperature ramp are applied to the sample (Figure A), and the resulting sinusoidal strain, and sine wave phase difference (δ) are measured (Figure B). From this data, storage modulus (E'), loss modulus (E''), and $\tan \delta$ (E'' / E') are calculated as functions of temperature, time, or stress (Figure C). This technique can be useful in the analysis of thin polymer films.

Dynamic TMA Mode (Q400em)

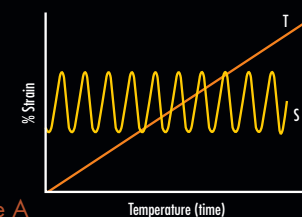

Figure A

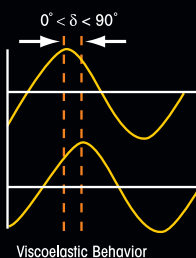

Figure B

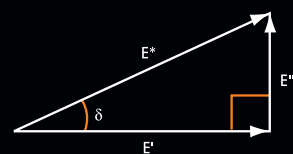

Figure C

$$E^* = \text{stress/strain}$$

$$E' = E^* \cos \delta$$

$$E'' = E^* \sin \delta$$

$$\tan \delta = E''/E'$$

MODULATED TMA™ (MTMA™; Q400EM)

In Modulated TMA (MTMA), the sample experiences the combined effects of a linear temperature ramp and a sinusoidal temperature of selected amplitude and period. The output signals (after Fourier transformation of the raw data) are total displacement and the change in thermal expansion coefficient. Both can be resolved into their reversing and non-reversing component signals. The reversing signal contains events attributable to dimension changes, and is useful in detecting related events (e.g., T_g). The non-reversing signal contains events that relate to time dependent kinetic processes (e.g., stress relaxation). This technique is unique to the Q400EM.

Modulated TMA (MTMA; Q400EM)

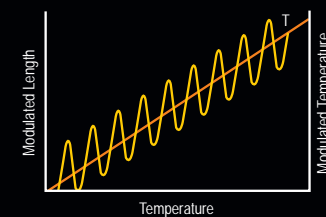

MECHANICAL COOLING ACCESSORY (MCA 70)



The MCA 70 is a new, high performance accessory for the Q400 and Q400EM Thermomechanical Analyzer that permits controlled cooling within the temperature range of 400 to -70 °C. With many new user convenience features, the MCA 70 is ideal for use in cyclic heating / cooling experiments that are increasingly being used by manufacturers to test materials under conditions of actual use and verify their performance.

APPLICATIONS

INTRINSIC AND PRODUCT PROPERTY MEASUREMENTS

The figure below shows expansion and penetration probe measurements of the Tg and the softening point of a synthetic rubber using a temperature ramp at constant applied force. The large CTE changes in the expansion plot indicate the transition temperatures. In penetration, the transitions are detected by the sharp deflection of the probe into the sample.

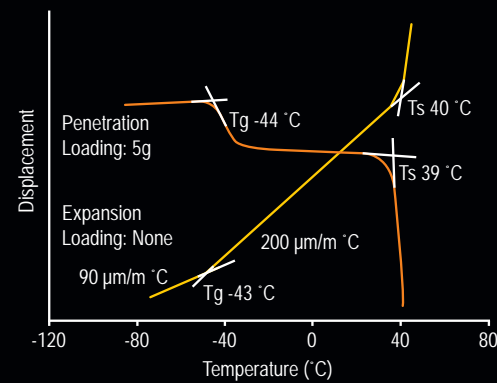

ACCURATE COEFFICIENT OF THERMAL EXPANSION MEASUREMENTS

The example below demonstrates the use of the expansion probe to accurately measure small CTE changes in an aluminum sample over a 200 °C temperature range. Advantage™ software permits analysis of the curve slope using a variety of methods to compute the CTE at a selected temperature, or over a range.

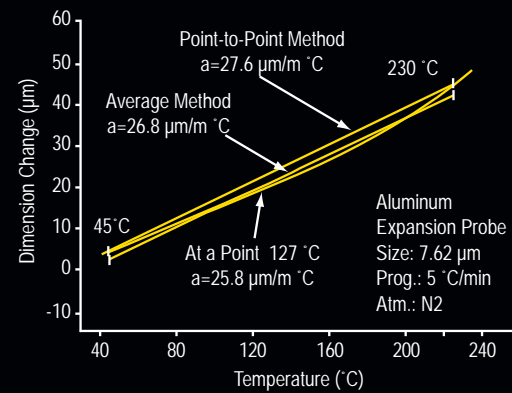

MATERIAL PERFORMANCE AND SELECTION

The figure below is an example of a 3-point bending mode (flexure probe) experiment on a polyvinyl chloride (PVC) sample, using the ASTM International Test Method E2092 to determine the distortion temperature or "deflection temperature under load" (DTUL). This test specifies the temperature at which a sample of defined dimensions produces a certain deflection under a given force. It has long been used for predicting material performance.

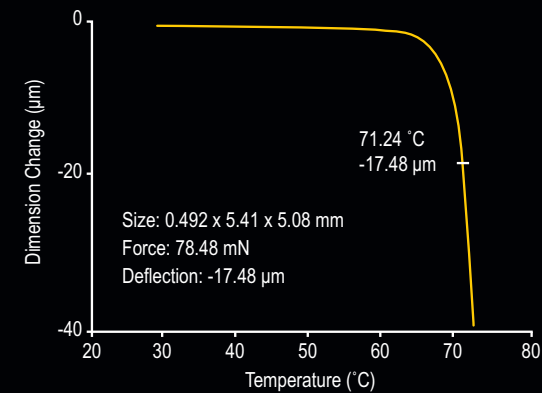

MULTILAYER FILM ANALYSIS

The figure below shows a compression mode analysis, using a penetration probe, of a double layer PE / PET film sample, supported on a metal substrate. The sample temperature was ramped from ambient to 275 °C at 5 °C/min. The plot shows probe penetrations of the PE layer (93.2 μm) at 103 °C, and the PET layer (14.8 μm) at 258 °C respectively.

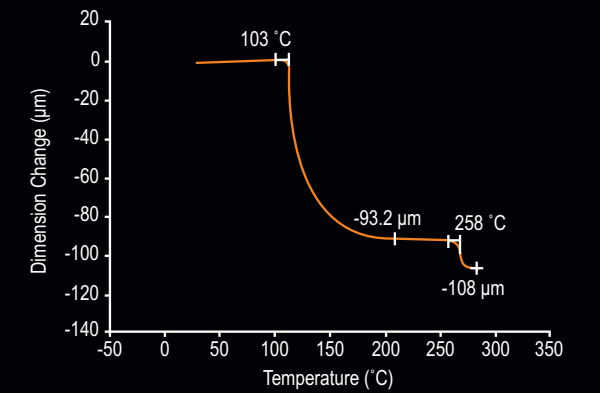

APPLICATIONS

SHRINKAGE FORCE TESTING

The figure below illustrates a classic shrinkage force (isostrain) experiment in the tensile mode on a food wrapping film. The film was strained to 20 % at room temperature for 5 minutes, cooled to -50 °C and held for 5 more minutes, then heated at 5 °C/min to 40 °C. The plot shows the force variation (shrinkage force) required to maintain a set strain in the film. This test simulates film use from the freezer to the microwave.

FILM TENSILE TESTING

The figure below displays a strain ramp experiment, at a constant temperature, on a polymeric film in tension. The plot shows an extensive region where stress and strain are linearly related, and over which a tensile modulus can be directly determined. Quantitative modulus data can also be plotted as a function of stress, strain, time, or temperature. The results show the ability of the Q400EM to function as a mini tensile tester for films and fibers.

FIBER STRESS/STRAIN MEASUREMENTS

Stress / strain measurements are widely used to assess and compare materials. The figure below shows the different regions of stress / strain behavior in a 25 μm polyamide fiber in tension, subjected to a force ramp at a constant temperature. The fiber undergoes instantaneous deformation, retardation, linear stress / strain response, and yield elongation. Other parameters (e.g., yield stress, Young's modulus) can be determined.

THERMAL STRESS ANALYSIS OF FIBERS

The figure below displays a tensile mode experiment, using a temperature ramp at a constant strain (1%), to perform a stress analysis on a polyolefin fiber, as received, and after cold drawing. The plot shows the forces needed to maintain the set strain as a function of temperature. The data has been correlated with key fiber industry processing parameters, such as shrink force, draw temperature, draw ratio, elongation at break, and knot strength.

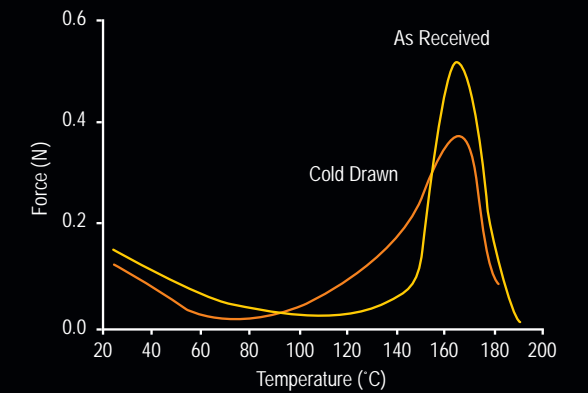
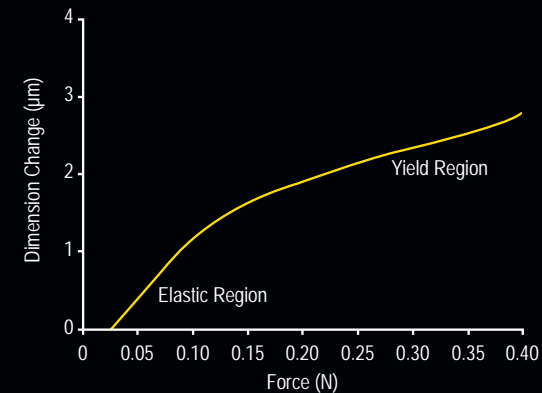
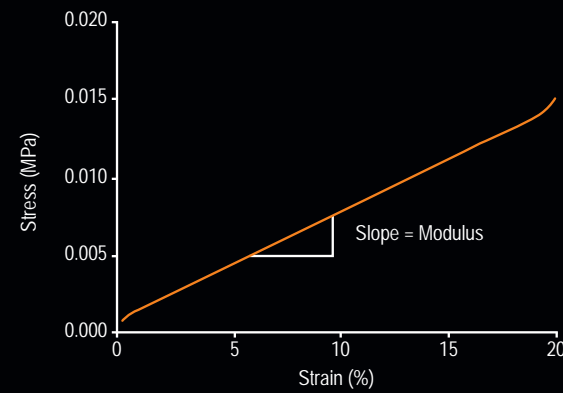
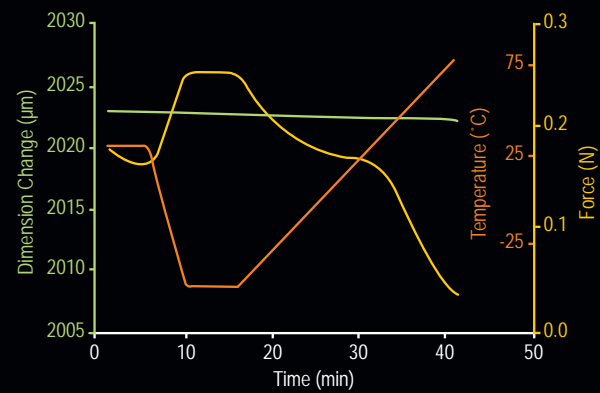

APPLICATIONS

CREEP ANALYSIS

Creep tests are valuable in materials selection for applications where stress changes are anticipated. The example below illustrates an ambient temperature creep study on a polyethylene film in tension. It reveals the instantaneous deformation, retardation, and linear regions of strain response to the set stress, plus its recovery with time, at zero stress. The data can also be plotted as compliance, and recoverable compliance, versus time.

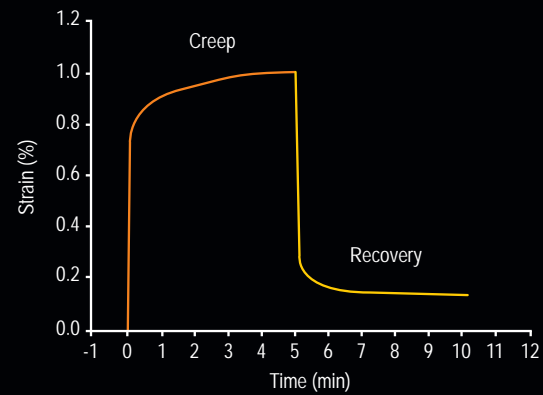

STRESS RELAXATION ANALYSIS

The figure below shows a stress relaxation test in tension on the same polyolefin film used for the creep study in the previous example. A known strain is applied to the film, and maintained, while its change in stress is monitored. The plot shows a typical decay in the stress relaxation modulus. Such tests also help engineers design materials for end uses where changes in deformation can be expected.

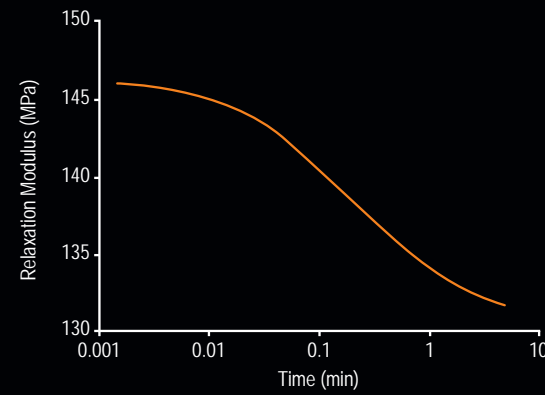

VISCOELASTIC PROPERTY DETERMINATION - DYNAMIC TMA

The figure below illustrates a dynamic test, in which a semi-crystalline polyethylene terephthalate (PET) film in tension is subjected to a fixed sinusoidal force during a linear temperature ramp. The resulting strain and phase data are used to calculate the material's viscoelastic properties (e.g., E' , E'' , and $\tan \delta$). The plotted data shows dramatic modulus changes as the film is heated through its glass transition temperature.

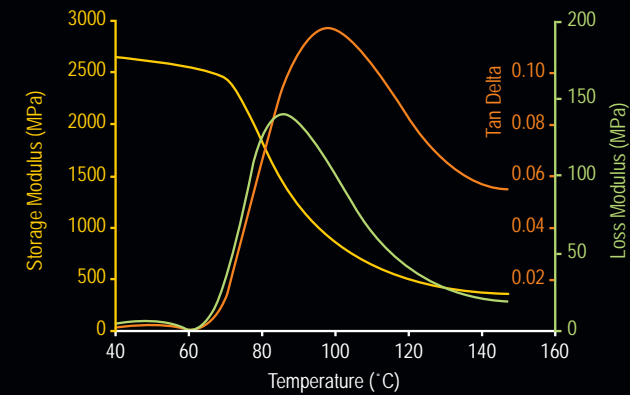

SEPARATING OVERLAPPING TRANSITIONS - MODULATED TMA™

Below shows a MTMA™ study to determine the T_g of a printed circuit board (PCB). The signals plotted are the total dimension change, plus its reversing and non-reversing components. The total signal is identical to that from standard TMA, but does not uniquely define the T_g . The component signals, however, clearly separate the actual T_g from the stress relaxation event induced by non-optimum processing of the PCB.

