

GC

Varian
CP-3800 GC

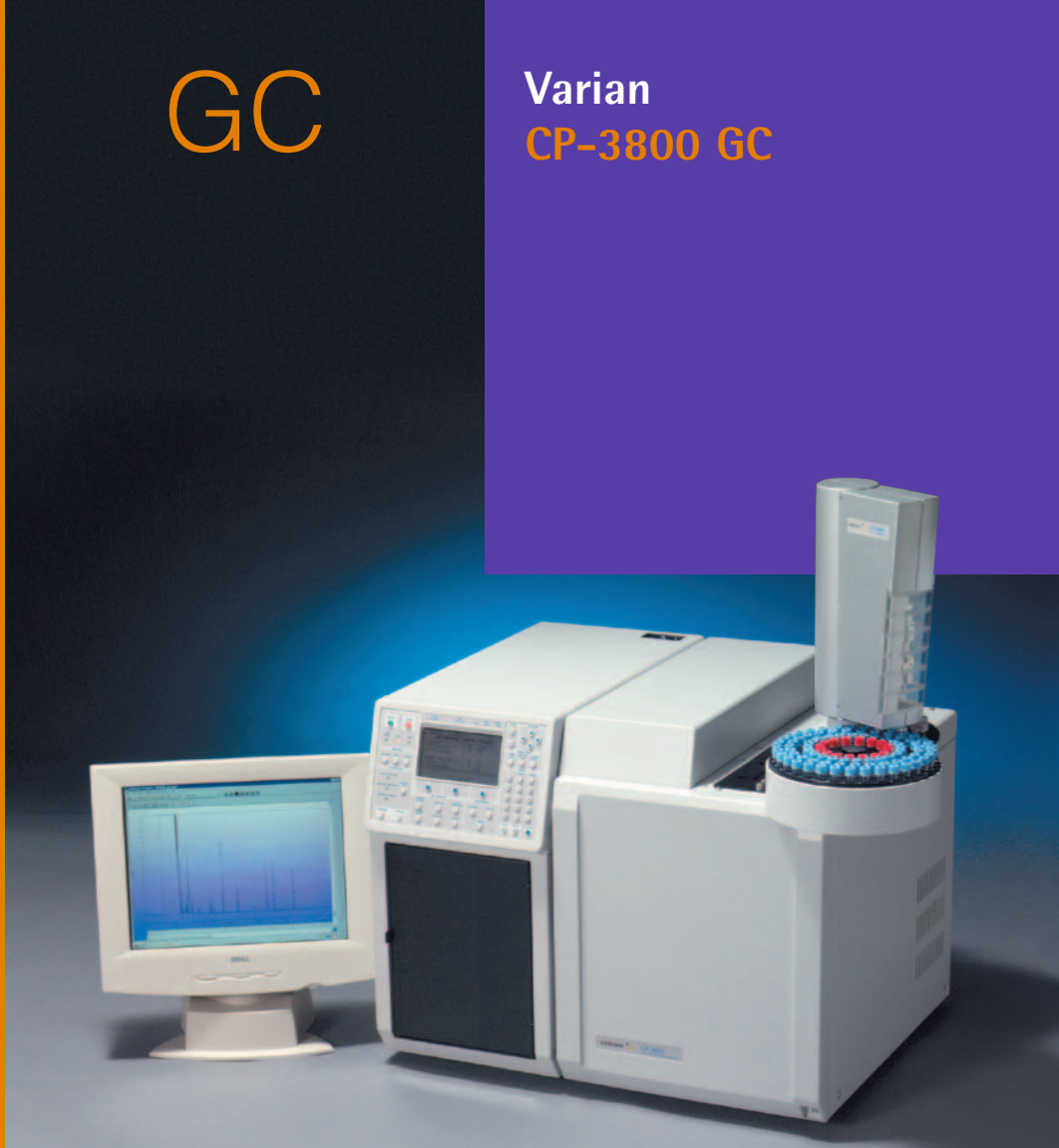

VARIAN

Outstanding Flexibility with Proven Performance

The Varian CP-3800 GC for any application

Flexible platform—single, dual, or three-channel configurations for maximum productivity.

Easy upgrades—quickly add additional capabilities as your requirements change.

Simplified PC control—streamline operation with intuitive, graphical interfaces for instrument control, data processing, and reporting.

The Varian CP-3800 GC meets all your analytical requirements with practical solutions for simple and complex applications.

In a standard configuration, the CP-3800 accommodates up to three injectors and three detectors, all operating simultaneously. In addition, the CP-3800 is easily configured to perform on-line analyses for monitoring critical gas and liquid process streams.

The CP-3800's flexible platform lets you start with a basic configuration and add a wide variety of options in the field. Options include additional channels, gas and liquid sampling valves, and external sampling devices. Future upgrades guarantee that you can meet changing requirements at a moment's notice.

Unleash the full potential of the CP-3800 GC with the Galaxie Chromatography Data System. Galaxie dramatically improves daily workflow with intuitive, easy-to-use graphical interfaces for instrument control, data acquisition, processing, and standard and custom reporting. From a simple stand-alone GC system, to an automated Simulated Distillation package, the CP-3800 GC with Galaxie provides a powerful solution to all of your GC analytical needs.

The CP-3800 GC from Varian—unlimited possibilities!



Simplified user interface

- Large display with 11 lines and 35 characters/line for easy viewing
- Easy method navigation for greater productivity
- Access to all GC parameters for complete method editing and system control

AutoSamplers

- CP-8400 handles up to 100 samples with liquid, ambient headspace, or optional SPME sampling modes
- CP-8410 with a fixed sample tray supports multiple vial sizes
- Combi PAL offers maximum flexibility for liquid, heated headspace, and SPME applications
- Archon™ with Tekmar Velocity XPT™ for automated Purge and Trap sampling

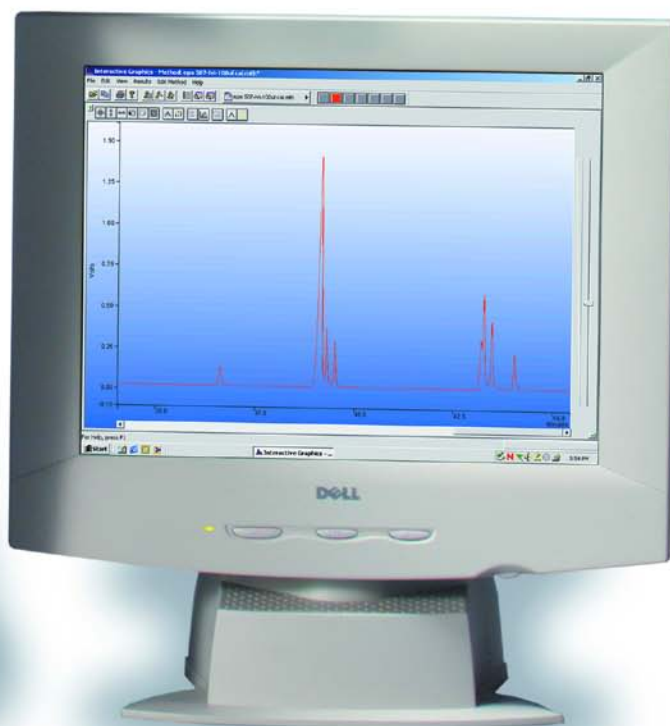

Injectors

- CP-1177 Split/Splitless Injector with optimized split vent design
- 1079 PTV (Programmable Temperature Vaporizing) injector for cold on-column, LVI (Large Volume Injection), and solid sample introduction with ChromatoProbe
- 1093 SPI (Septum-Equipped Programmable Injector) for high temperature capillary column applications
- 1041 On-Column/Packed Injector for 0.53 mm ID capillary and packed column applications
- 1061 Flash Injector for simplified direct injections
- Valve systems for gas and high pressure liquid samples
- Integrated SPT (Sample Preconcentration Trap) for concentrating gas samples

Column oven

- Spacious oven accommodates three or more columns
- Varian Quick Connects provide easy column installation
- Rapid oven cool down increases sample throughput
- Cryogenic cooling extends application range

Detectors

- Flame Ionization (FID) with a patented, ceramic flame tip for ultimate peak shape and sensitivity
- Thermal Conductivity (TCD) with automatic filament protection for lowest maintenance costs
- Electron Capture (ECD) for ultra-high sensitivity and selectivity of halogenated compounds
- Thermionic Specific (TSD) for selective detection of nitrogen/phosphorus compounds
- Pulsed Flame Photometric (PFPD) for selective detection of sulfur, phosphorus, nitrogen, and 25 additional elements

Galaxie Chromatography Data System

- Simple interface for easy method building and data acquisition
- Password protection eliminates unauthorized data access and method editing
- Easy for occasional users with customized screens showing just the information needed

Simplified User Interface

For convenient system navigation and method editing

Intuitive keypad buttons and large display simplify daily operation.

- Easy viewing with 11 lines and 35 characters/line LCD screen
- Quickly view GC status and edit GC parameters from the keypad
- Complete method editing and GC control via keypad
- Save time with immediate access to any one of eight methods stored in on-board memory

All CP-3800 GC functions at your fingertips for quick access at any time.

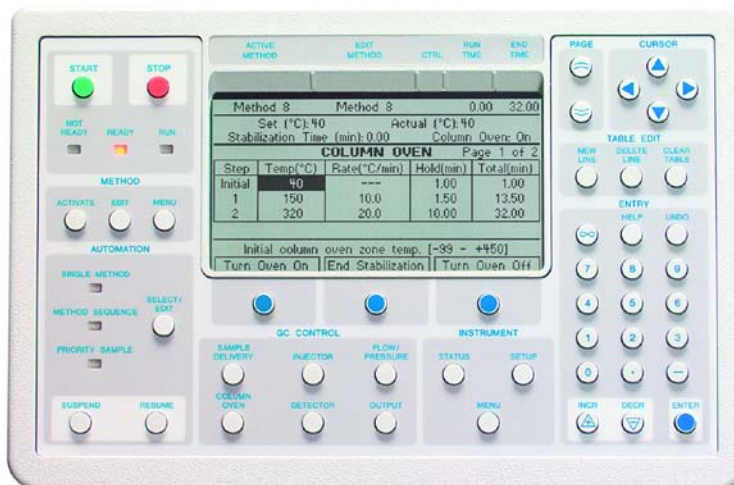

Navigate method parameters. Use section-specific soft keys to access and edit method parameters independent of PC workstation.

Component	Set	Actual
1177 Oven (°C)	220	220
Column Flow (ml/min)		4.0
Column Pressure (psi)	5.0	5.0
Column Oven Temp (°C)	199	199
TSD Oven (°C)	300	300
TSD Output (mV)		65.901

Software Ver. Actual size

Complete GC status in a single screen. View channel-specific information at the touch of a button.

Maximize Sample Throughput

Versatile autosamplers minimize errors and reduce costs

The CP-8400 AutoSampler provides high throughput with a standard 100 sample carousel for 2 mL vials. The CP-8410 AutoInjector provides flexibility with a fixed tray for 2 mL, 5 mL, and 10 mL vials.

- High sample throughput with dual and duplicate modes of injection
- Automatically access two injectors with a single tower
- Minimize method development time with pre-programmed modes of injection
- Liquid, ambient headspace, and SPME sampling

Varian AutoSamplers elevate GC automation to new levels of reliability, productivity, and performance.



Save time and reduce costs. The CP-8400 AutoSampler provides dual and duplicate injections with only a single tower.

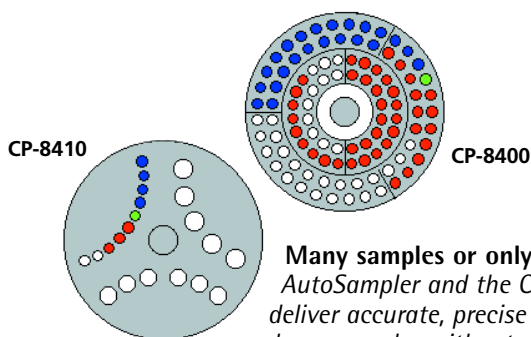

Many samples or only a few. The CP-8400 AutoSampler and the CP-8410 AutoInjector deliver accurate, precise injections of small or large samples without sample carryover.

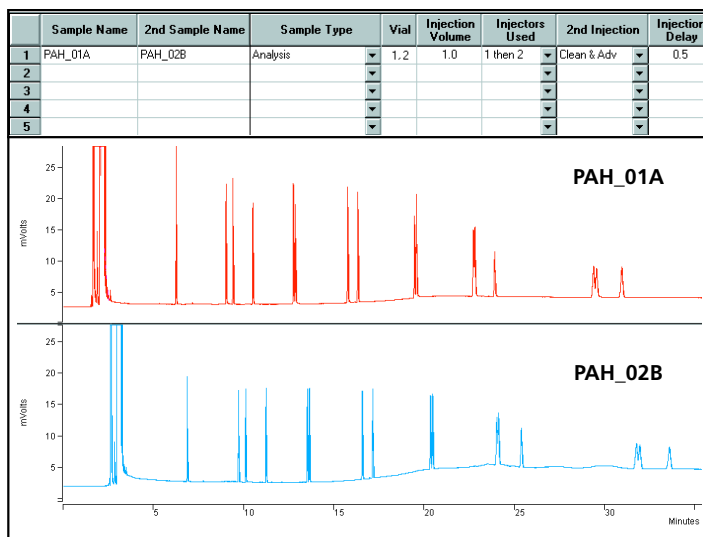

Double throughput without additional hardware costs! Dual sample injection mode for a 16-component Polynuclear Aromatic Hydrocarbon mixture injected into two injectors sequentially.

Automated Sample Preparation For volatile and semi-volatile applications

In addition to traditional liquid autosamplers, the CP-3800 GC conveniently interfaces with a wide range of automation devices.

For example, the Varian Archon and the Combi PAL combine both sample preparation and sample introduction in a single unit. Archon sets the industry standard for Purge and Trap automation (e.g., USEPA Method 5035). Combi PAL is the only GC sampling device that automates liquid and heated headspace injections, plus solid phase microextraction (SPME).

Configuring the CP-3800 with advanced sampling devices minimizes sample preparation time associated with demanding samples.



Eliminate solvents. *Combi PAL's advanced SPME mode with agitation and heating rapidly extracts semi-volatile samples without costly solvents.*



Reduce carryover. *Archon's automated hot water rinse effectively flushes contaminants from prior samples for improved analytical results.*

Exceptional Performance

Optimized injectors for every application

Varian has the injector to meet every application need. All Varian injectors for the CP-3800 are available with Electronic Flow Control (EFC) or manual pneumatics.

Varian's EFC optimizes GC injector performance by electronically controlling column pressure, flow, and split vent flow. Also, EFC's pressure pulse capability lets you increase injection volumes for greater sensitivity without injector overload.

Also, EFC modules are designed for special inlet configurations such as purge and trap, headspace, and valved systems for maximum performance. In addition, EFC conserves costly carrier gas with convenient software control by reducing the split vent flow between injections.

Simplify injector set-up, shorten method development time, and facilitate application troubleshooting with EFC from Varian.

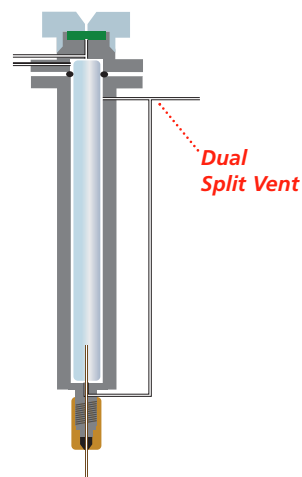

Minimal solvent tailing. Dual split vent efficiently eliminates residual solvent for improved sensitivity.

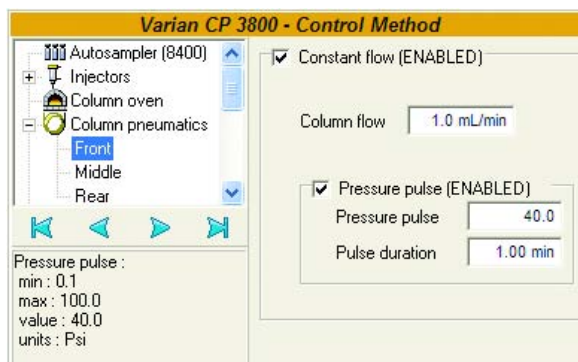

Convenient injector interface. Intuitive screens provide quick and easy set-up for all injection parameters including pressure pulse.



Eliminate injection start errors. Varian's AutoStart switch is automatically activated by the syringe to guarantee that every run starts immediately when the sample is injected.

Difficult Samples

Versatile inlet devices for the results you need

1079 PTV Injector

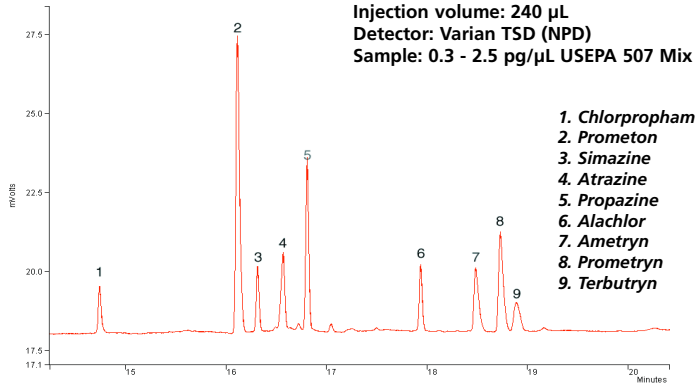

Reduce sample prep time and costs. Large Volume Injections (LVI) improve laboratory productivity while maximizing sensitivity and minimizing solvent use.

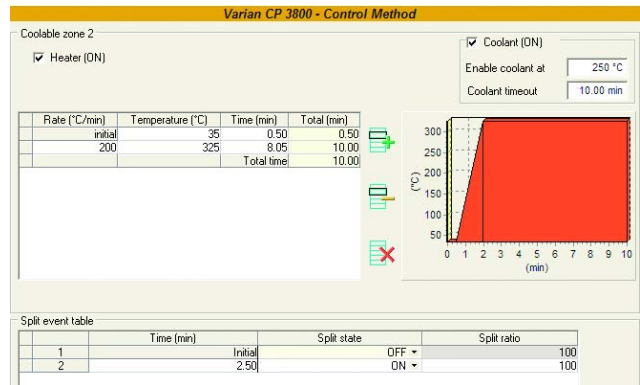

Easy temperature programming. Intuitive interface makes the 1079 PTV easy to set up for cold on-column or large volume injections.

No Sample Preparation Required with ChromatoProbe

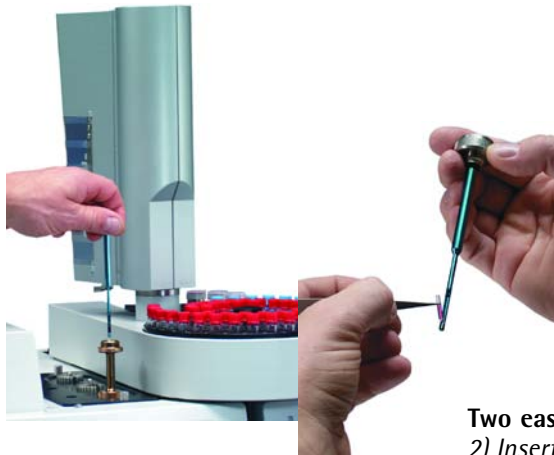

Varian's revolutionary ChromatoProbe:

- Analyzes solids, liquids, and slurries without any sample preparation
- Directly desorbs samples in the 1079 PTV Injector without additional hardware
- Uses disposable micro-vials to minimize system contamination

Two easy steps. 1) Place sample micro-vial into probe. 2) Insert probe into 1079 PTV Injector.

Universal and Selective Detectors

Ultimate sensitivity for demanding applications

Demanding applications require rugged and reliable detectors to assure quality results. Universal detectors provide high sensitivity for a wide range of routine samples. Varian's selective detectors specifically eliminate matrix interferences while providing maximum sensitivity.

All Varian detectors for the CP-3800 are available with EFC or manual pneumatics. With EFC, gas flows are optimized for each detector assuring easy set-up and operation.

Varian's comprehensive line of detectors guarantees a cost-effective solution to your application requirements.



Ultimate sensitivity—setting the industry standard. *Varian's ECD provides ultra-high sensitivity for halogenated compounds, such as 7 fg/sec for Lindane.*

Flame Ionization Detector

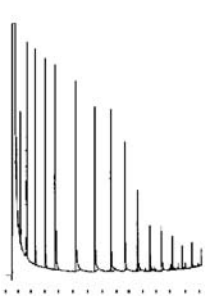

Metal Flame Tip

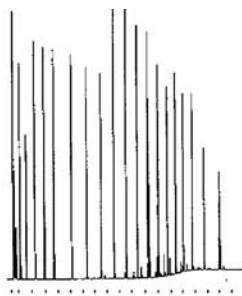

Ceramic Flame Tip

Improved analyte response. *The Varian FID, with its standard ceramic flame tip, delivers improved response for high molecular weight compounds.*

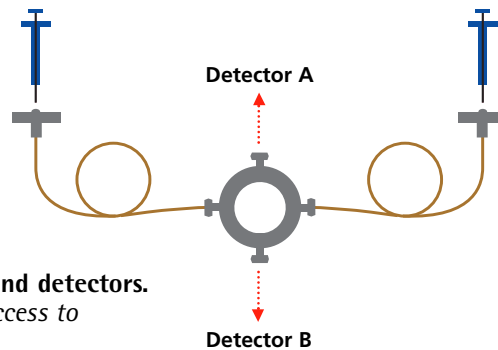

Instantly switch between injector/columns and detectors. *The Quick-Switch Valve provides immediate access to multiple injectors/columns and detectors.*

Highly Selective Pulsed FPD

Eliminates matrix interferences for greater sensitivity

The Varian PFPD provides selective detection for sulfur, phosphorus, nitrogen, and 25 additional elements. A unique time-gated electrometer and optical filters eliminate background signal from hydrocarbon interferences.

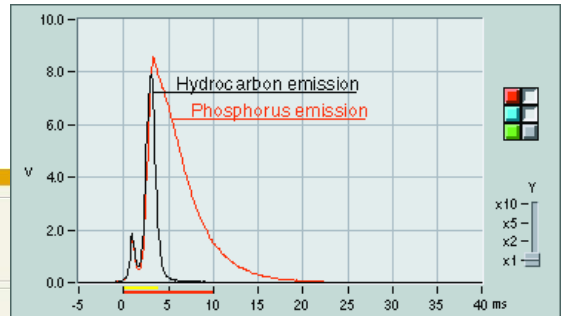
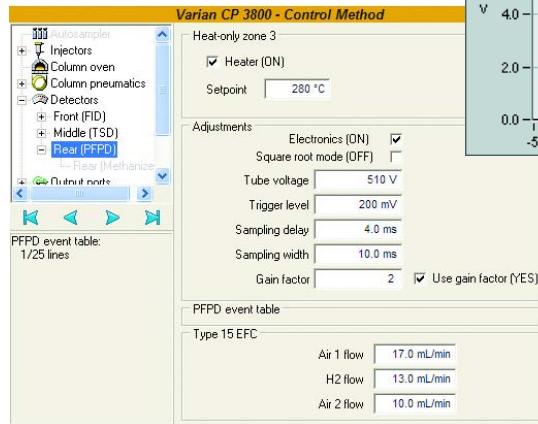

Eliminate interferences. Use programmable Gate Delay and Gate Width eliminate hydrocarbon background for greater selectivity and sensitivity.

Trace Sulfur Contaminants in Beverage-Grade CO₂

0.2 ppm Sulfur Gases

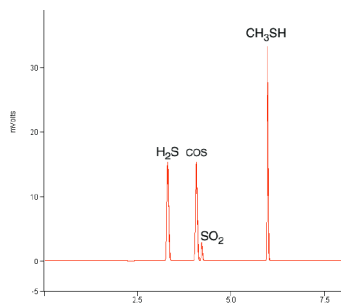

Easy-to-operate, reliable sulfur detection. The PFPD provides a simpler, more cost-effective alternative to chemiluminescence for many trace sulfur analyses.

Superior Phosphorus Pesticide Analysis

0.10 µg/mL for Each Pesticide in Broccoli Extract

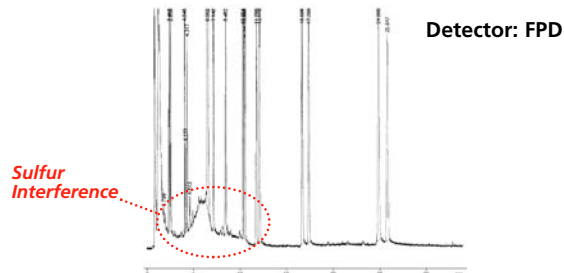
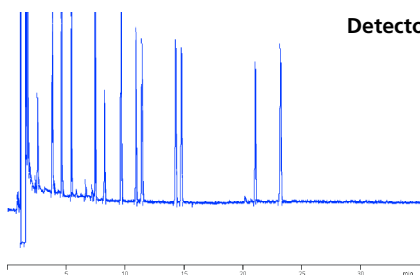

Improve phosphorus detection 10-fold. Compared to the FPD, the pulsed operation of the PFPD selectively eliminates sulfur interferences during the analysis of phosphorus pesticides.

Custom GC Solutions

Simple solutions for complex separations

Varian has long been the leader in providing turn-key solutions for industrial, petrochemical, and environmental applications. The CP-3800's flexible platform easily supports a wide range of GC analyzers from a single Gas Sampling Valve with packed column for permanent gas analysis to an advanced four-valve, three-channel system with multiple columns for Refinery Gas Analysis.

The Varian CP-3800 advantage:

- Eliminate application development time with standard and custom analyzers
- Column switching, series/bypass, backflush, and sample injection easily handled by single or multi-valve oven configurations
- Minimize baseline upsets with rapidly responding EFC optimized for valved configuration
- Improve sensitivity for trace gas analysis by concentrating samples with an integrated Sample Preconcentration Trap (SPT)
- Automatically switch between multiple sample streams with a stream-selector valve

Varian manufactures, tests, installs, and supports these special configurations for the lifetime of your system. Our single vendor approach assures you the best possible return on your investment.



Always compact. Even with multi-valve, multi-column, and multi-detector configurations, the CP-3800 retains its compact footprint and ease-of-use.

Varian Analyzers: User defined, Varian tested!

Boost productivity, reduce operating costs

Varian offers a range of CP-3800-based solutions from standard GC analyzers for natural gas analysis to custom analyzers defined by you for your specific application. All Varian analyzers are factory tested to guarantee full performance with minimal start-up time.

Complete with test results, documentation, and reference manual, your Varian Custom GC Solution will provide years of reliable, productive service.



Quick and easy access. Varian's multi-valve oven with removable cover leaves actuators in place while providing complete access for valve troubleshooting and maintenance.

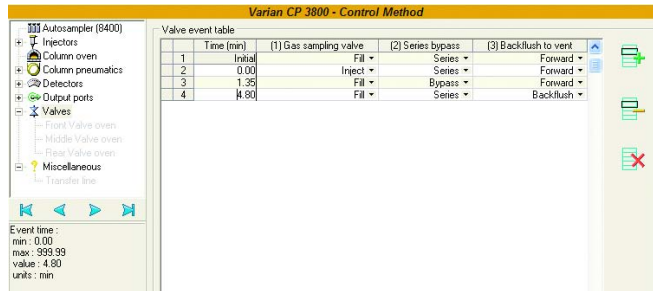

Total control. Galaxie Workstation controls valve switching and provides easy valve identification.

Superior Sensitivity for Organic Components in Gases and Ambient Air



Enhanced sensitivity. Varian's patented SPT concentrates trace analytes in air and gas samples for on-line processes and field samples brought to the laboratory.

2 ppb Ethylene in Air from a Food Processing Facility

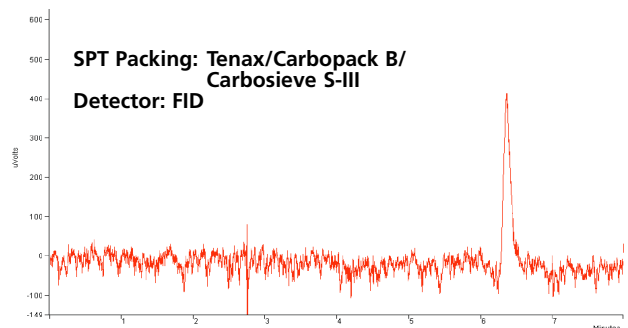

Your choice of packing. With the Varian SPT, select from a variety of different packing materials for optimum selectivity and maximum sensitivity. Varian GC Application Note No. 65.

User-Friendly Galaxie Chromatography Data System

Begin with the basics and upgrade as needed

The Galaxie data handling solution improves daily workflow with easy-to-use graphical interfaces for data acquisition, processing, and reporting.

- Complete control of the CP-3800 including injectors, valves, autosamplers, concentration traps, and detectors
- Instrument communication utilizing standard network protocols (TCP/IP)
- Client/server architecture provides unlimited instrument control and data handling with no maximum distance between instrument and computer
- Complete user access rights to projects, instruments, and data with rigorous audit trails.

Start with a single Galaxie GC Workstation, and scale up to control multiple of the GCs as well as LCs in your lab using the Galaxie client/server solution.

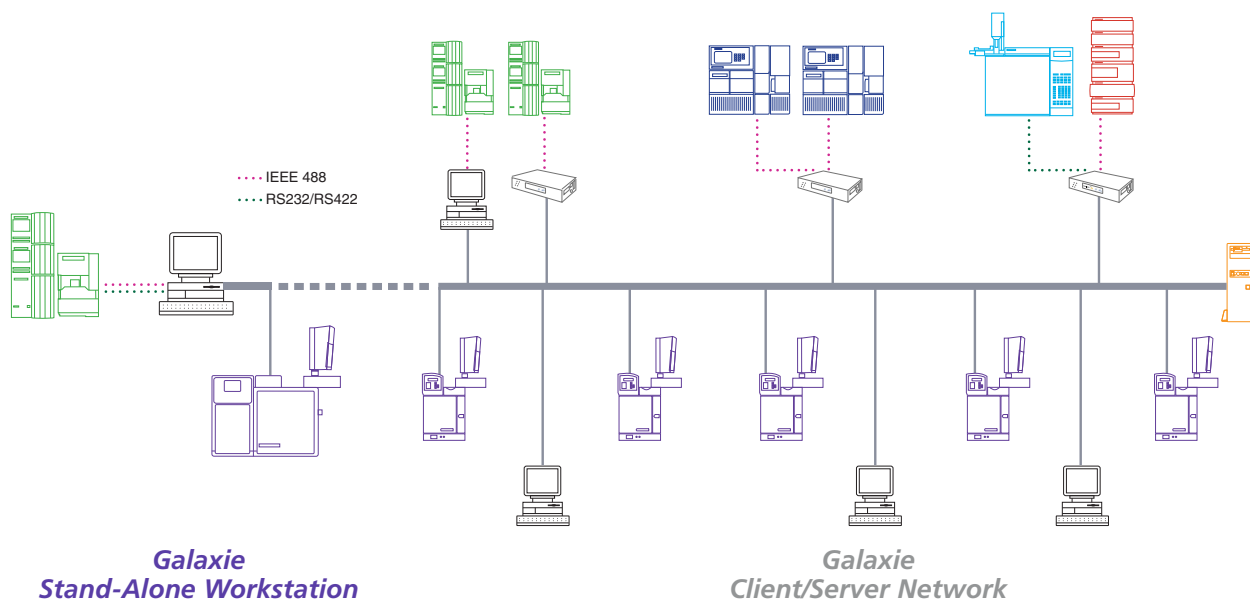

Scalable stand-alone workstation to client/server solution. Galaxie offers a unique combination of scalable hardware and software to meet the widest range of requirements for instrument control and data management.

Superior Ease-of-Use

Increase productivity with simplified displays

Rapidly Build Rugged Methods

Instrument control and data handling methods are quickly generated with Galaxie's intuitive graphical interface to deliver dependable results.

For more reliable peak identification, Galaxie provides a choice of absolute retention times, relative retention times, or Kovats retention indices. To correctly select from several candidates in the same time window, an additional peak ID algorithm can be applied.

Building peak integration methods for complex chromatograms is simplified with on-screen editing and display of more than 20 peak integration events.

Peak identification and measurement are assured with Galaxie.

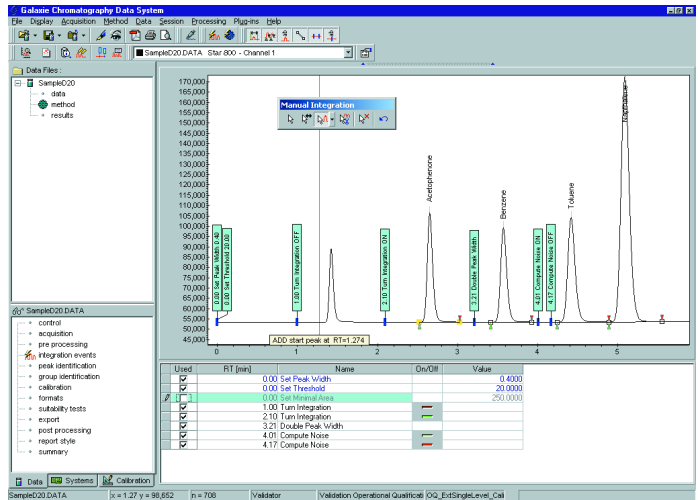

Easy method building. Interactive on-screen graphics and powerful algorithms deliver dependable peak identification and area measurements.

Calibrate for Productivity

Galaxie provides a wide range of calculation types and curve fitting algorithms (e.g., linear, quadratic, and cubic). Calibration functions are managed interactively on-screen. Curves are edited with immediate recalculation of curve coefficients.

Calibration data are automatically archived, sorted by date or component, and are always retrievable at the click of a mouse.

Galaxie lets you spend more time analyzing samples and less time on calibration.

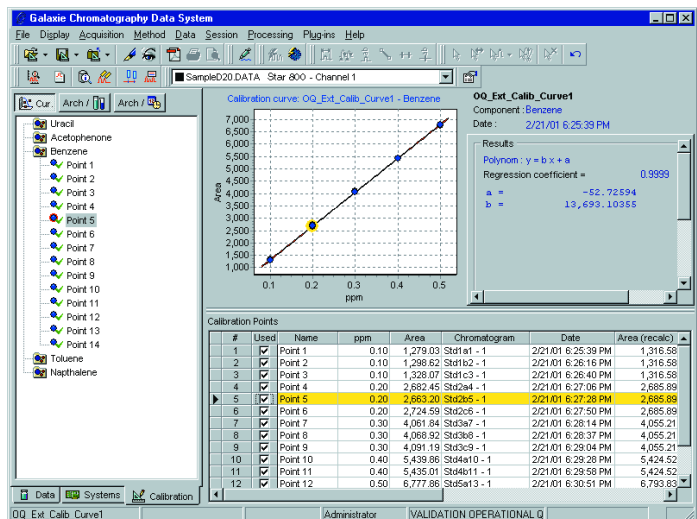

Manage calibration data with speed. Data is generated, edited, archived, and retrieved faster with Galaxie.

Answering Questions, Making Decisions

Easy-to-create, flexible reports

Customized Reports in Seconds

Galaxie reports answer the questions asked by chromatographers every day. Reports contain only relevant information and display the facts required to release a product, monitor a process, or answer a specific inquiry.

With Galaxie Report Editor, customized report formats are quickly produced. Objects, including chromatograms, result tables, calibration curves, peak purity results, and UV spectral library searches can be inserted and resized with the mouse. Fonts and orientation can be changed just as easily.

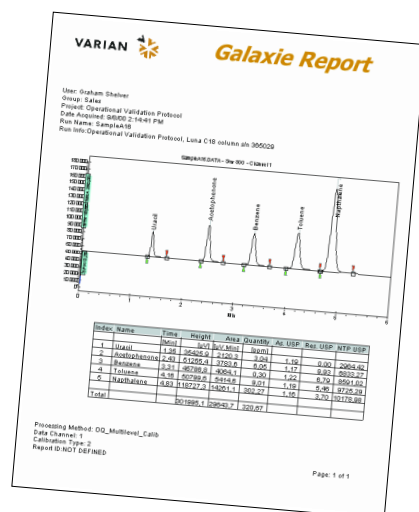

Just the facts with Report Editor. Quickly customize reports on-screen for routine and research results.

Simple Summaries

Galaxie's Summary Report tool provides advanced data handling such as statistics and control charts for multiple chromatograms. By highlighting a series of chromatograms, tabular and graphical reports are easily generated.

The Summary Report tool frequently allows users to bypass the complexity of working with databases.

Galaxie—for simple, statistically sound management of data quality.

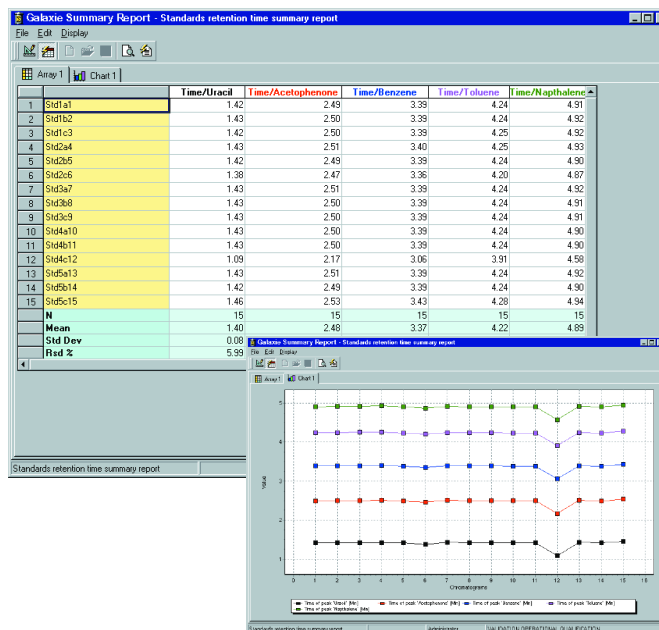

Easily track results and trends. Control charts monitor data quality by tracking sample trends or chromatographic variables.

Meeting Your Analytical Needs

Varian systems, services, and supplies

Varian's 50-plus years of continuous innovation in analytical instrumentation and consumables assures you the best in high performance products and services. Varian is committed to providing innovative consumable products backed by expert technical support.

Advance your analytical capabilities today. Speak with a Varian representative to discuss your specific application needs. Call today to request your free Varian catalog or Shop Varian Online at www.varianinc.com.



SPEC® Solid Phase Extraction Products.
Monolithic disc technology delivers faster sampling processing and consistently high recoveries at low elution volumes.



Varian FactorFour Capillary GC Columns.
FactorFour columns deliver increased sensitivity and longer column life with a bleed specification up to four-fold lower than competitive products.



Varian Gas Clean Filters. *Extremely efficient filters remove moisture and oxygen to extend column life and improve system performance.*

[Shop Varian](#)

Shop Varian Online. *Thousands of products for GC, LC, MS, AA, ICP, UV/Vis, and sample preparation from Varian, ANSYS, and other leading manufacturers are available online at www.varianinc.com.*

Varian, Inc.
providing innovative tools
for applications in:

Pharmaceutical
Genomics/Proteomics
Bioscience
Neuroscience
Academic Research
Drug Testing
Petrochemical
Environmental
Food and Beverage
Industrial R&D and Quality Control



Varian is committed to a process of continuous improvement which demands that we understand and then meet or exceed the needs and expectations of our customers – both inside and outside the company – in everything we do.

• **Varian Sales and Dealer Offices**



All trademarks are the property of their respective owners.



VARIAN

Varian, Inc. • www.varianinc.com

- **North America** 800.926.3000, 925.939.2400
- **Europe** The Netherlands: 31.118.67.1000
- **Asia Pacific** Australia: 613.9560.7133
- **Latin America** Brazil: 55.11.3845.0444
- **Other sales offices and dealers throughout the world**

GC • LC • MS • AAS • ICP • UV-Vis-NIR • Fluorescence • Dissolution • NMR • Consumable Products